

ORIENTATION
 ← FRONT

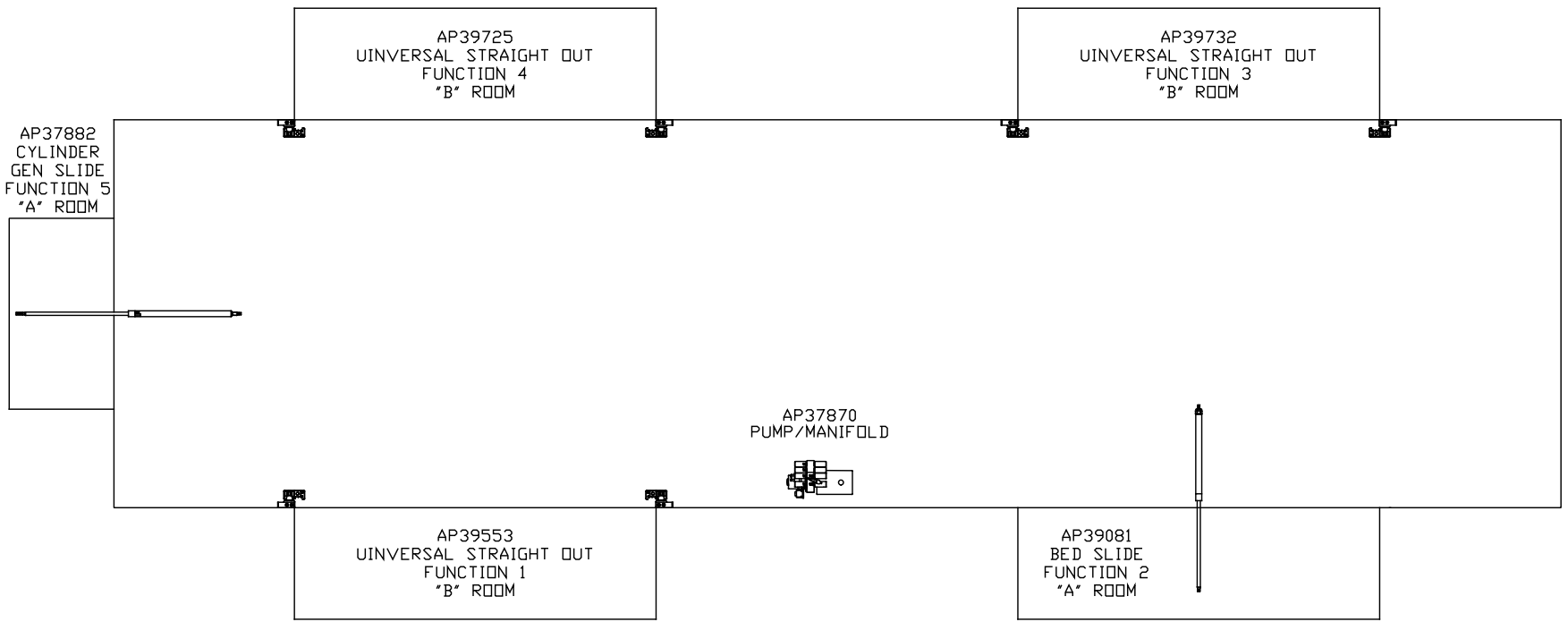

NOTE: INSTALLATION MUST CONFORM TO GOOD SHOP PRACTICES, SAE STANDARDS, RVIA STANDARDS, AND OTHER APPLICABLE STANDARDS.

LEVELING SYSTEM: AP44672

		HWH I-80 EXIT 267 SOUTH RT 1 MOSCOW, IOWA 52760	
		SCALE 1:6	DATE 13JUL12
		DRAWN BY .	
		HYD CONN DIAGRAM	
		FORETRAVEL	
		DRAWING NUMBER MP70563 A/E	
▲	01FEB13	WAS AP39733 & AP39734	
NO.	DATE	REVISION	
THE INFORMATION DISCLOSED ON THIS DRAWING IS CONFIDENTIAL AND MUST NOT BE DISCLOSED OR USED IN ANY MANNER WHICH WILL BE DETRIMENTAL TO THE HWH CORPORATION			

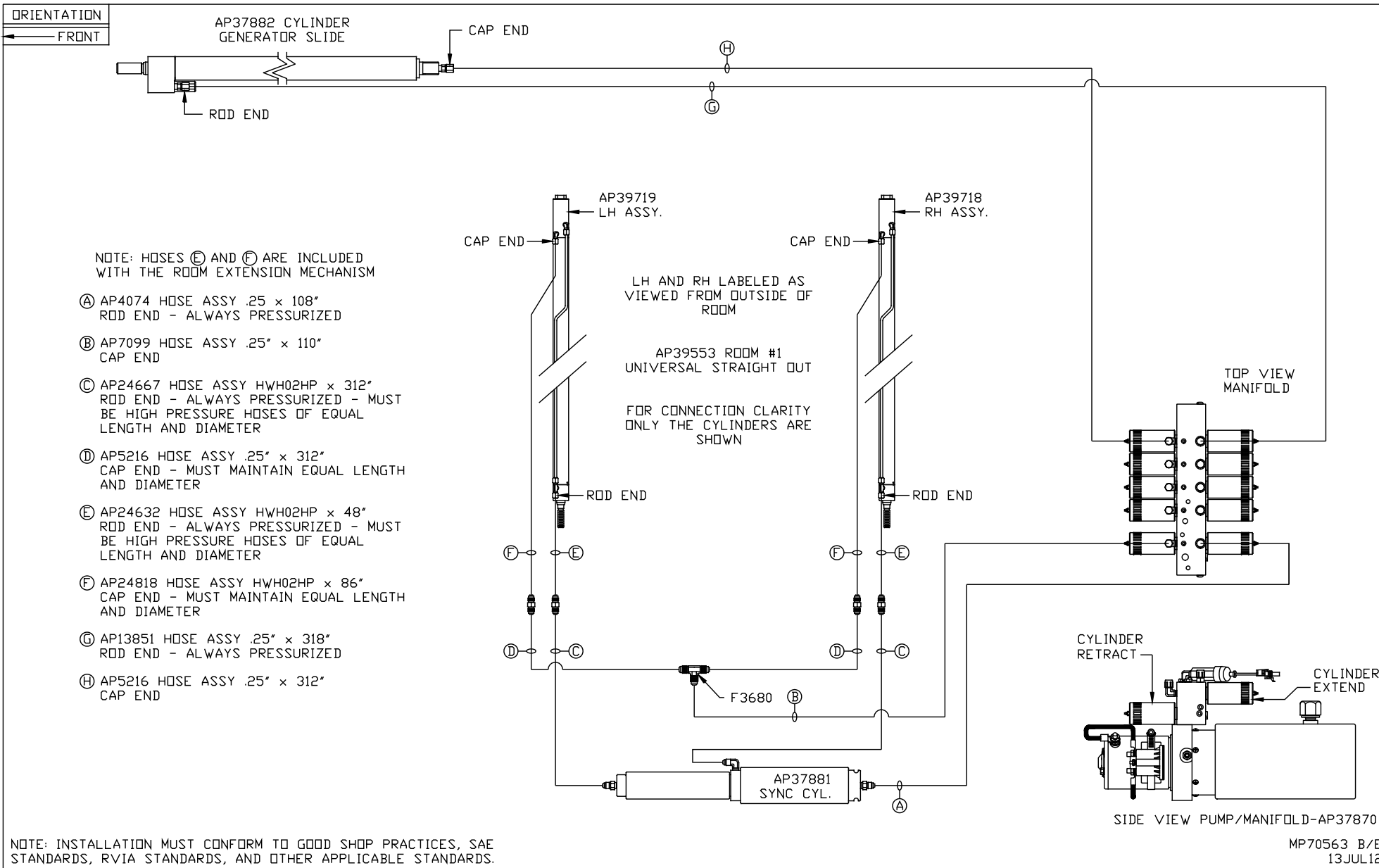

ORIENTATION

← FRONT

NOTE: HOSES ③, ④ AND ⑤ ARE INCLUDED WITH THE ROOM EXTENSION MECHANISM

- ① AP4164 HOSE ASSY .25 x 384"
ROD END - ALWAYS PRESSURIZED
- ② AP4391 HOSE ASSY .25 x 372"
CAP END
- ③ AP24632 HOSE ASSY HWH02HP x 48"
ROD END - ALWAYS PRESSURIZED
- ④ AP24628 HOSE ASSY HWH02HP x 24.25"
CAP END
- ⑤ AP25677 HOSE ASSY HWH02HP x 20"
CAP END

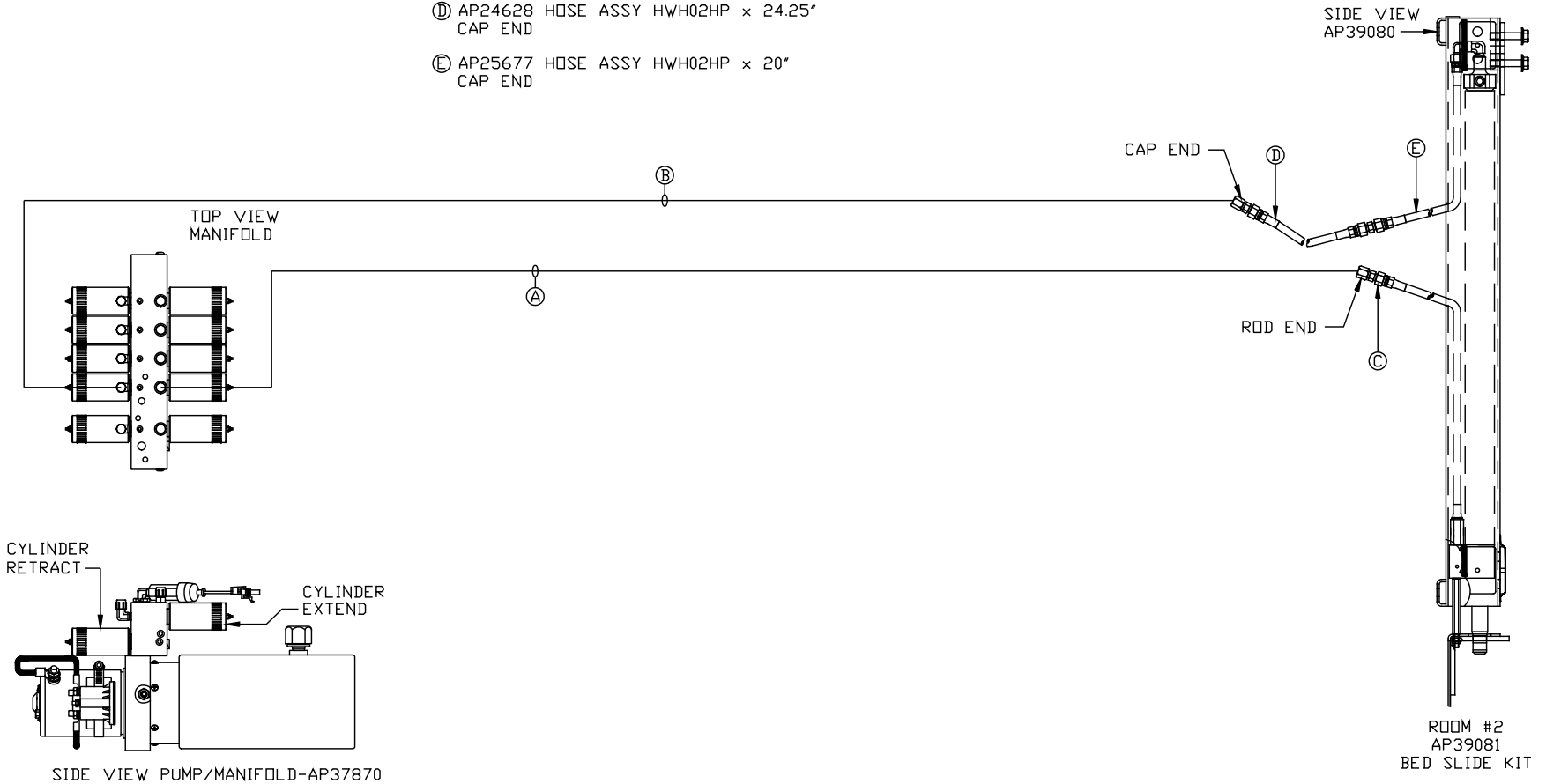

NOTE: INSTALLATION MUST CONFORM TO GOOD SHOP PRACTICES, SAE STANDARDS, RVIA STANDARDS, AND OTHER APPLICABLE STANDARDS.

MP70563 C/E
13JUL12

ORIENTATION

← FRONT

NOTE: HOSES ③ AND ④ ARE INCLUDED WITH THE ROOM EXTENSION MECHANISM

- ① AP24667 HOSE ASSY HWH02HP x 318" ROD END - ALWAYS PRESSURIZED
- ② AP2464 HOSE ASSY .25 x 324" CAP END
- ③ AP25086 HOSE ASSY HWH02HP x 78" WAS AP24631 HOSE ASSY HWH02HP x 42" ROD END - ALWAYS PRESSURIZED - MUST BE HIGH PRESSURE HOSES OF EQUAL LENGTH AND DIAMETER
- ④ AP24819 HOSE ASSY HWH02HP x 100" WAS AP24637 HOSE ASSY HWH02HP x 66" CAP END - MUST MAINTAIN EQUAL LENGTH AND DIAMETER

TOP VIEW MANIFOLD

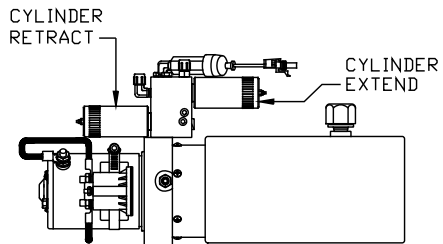
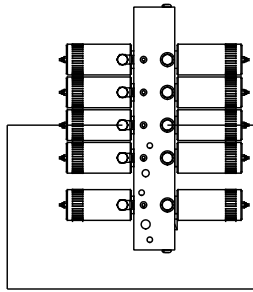

SIDE VIEW PUMP/MANIFOLD-AP37870

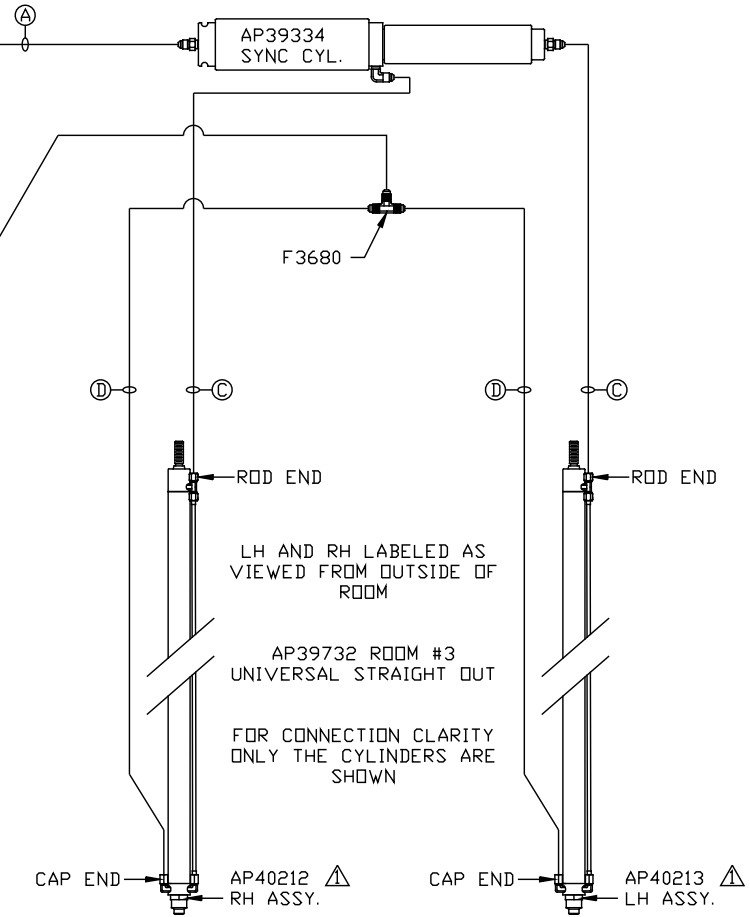

NOTE: INSTALLATION MUST CONFORM TO GOOD SHOP PRACTICES, SAE STANDARDS, RVIA STANDARDS, AND OTHER APPLICABLE STANDARDS.

MP70563 D/E
01FEB13

ORIENTATION
 ← FRONT

NOTE: HOSES (E) AND (F) ARE INCLUDED WITH THE ROOM EXTENSION MECHANISM

- (A) AP4074 HOSE ASSY .25" x 108"
ROD END - ALWAYS PRESSURIZED
- (B) AP7099 HOSE ASSY .25" x 110"
CAP END
- (C) AP24667 HOSE ASSY HWH02HP x 312"
ROD END - ALWAYS PRESSURIZED - MUST BE HIGH PRESSURE HOSES OF EQUAL LENGTH AND DIAMETER
- (D) AP5216 HOSE ASSY .25" x 312"
CAP END - MUST MAINTAIN EQUAL LENGTH AND DIAMETER
- (E) AP24632 HOSE ASSY HWH02HP x 48"
ROD END - ALWAYS PRESSURIZED - MUST BE HIGH PRESSURE HOSES OF EQUAL LENGTH AND DIAMETER
- (F) AP24818 HOSE ASSY HWH02HP x 86"
CAP END - MUST MAINTAIN EQUAL LENGTH AND DIAMETER

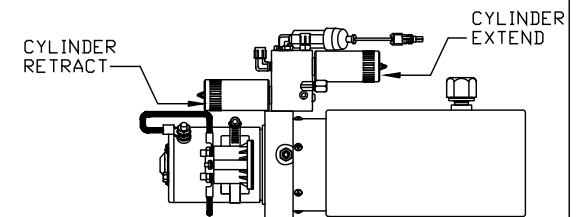
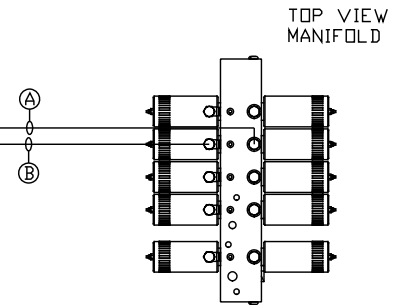
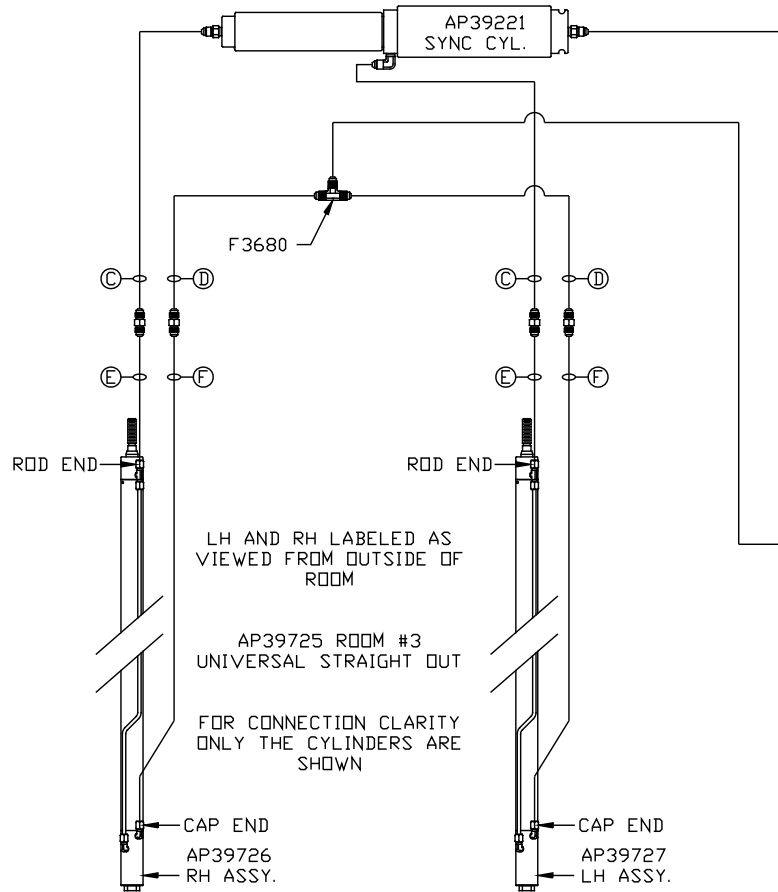

SIDE VIEW PUMP/MANIFOLD-AP37870

NOTE: INSTALLATION MUST CONFORM TO GOOD SHOP PRACTICES, SAE STANDARDS, RVIA STANDARDS, AND OTHER APPLICABLE STANDARDS.

MP70563 E/E
 13JUL12