

AP28897 CN1<BLACK>  
PIN  
1 N/C  
2 N/C  
3 RED<W6800> SW BATT  
4 WHT<W6230> GROUND  
5 CAN SHIELD  
6 N/C  
7 GRN CAN LOW  
8 YEL CAN HI

AP28897 CN10<GRAY>  
PIN  
1 BLK <W7599> SWITCH LIGHT CONTROL  
2 RED <W6100> RESET OUT  
3 BLK <W7550> RESET IN  
4 RED <W6121> WARN LIGHT SUPPLY  
5 WHT <W6230> SWITCH LIGHT SUPPLY  
6 BLK <W7699> WARN LIGHT/BUZZER CONTROL

AP28897 CN11<GRAY>  
PIN  
1 RED<W6110> IGNITION  
2 N/C  
3 N/C  
4 N/C  
5 RED<W6120> ACCESSORY  
6 RED<W6100> HOUSE BATTERY  
7 WHT<W6230> GROUND  
8 N/C  
9 N/C  
10 N/C  
11 BLK<W9000> PARK BRAKE SWITCH  
12 RED<W6101> ENGINE BATTERY

AP28897 CN9<GREEN>  
PIN  
1 BLK <W8500> MASTER RELAY CONTROL  
2 BLK <W8100> SYSTEM PSW  
3 N/C  
4 BLK <W8600> PMP RELAY CONTROL  
5 BLK <W9900> SPEED SWITCH  
6 BLK <W9901> PUMP MONITOR  
7 N/C  
8 N/C

AP27607<BROWN>  
PIN  
1 N/C  
2 BLK<W1500> LEFT FRONT RAISE  
3 BLK<W1600> LEFT FRONT LOWER  
4 BLK<W2500> RIGHT FRONT RAISE  
5 BLK<W2600> RIGHT FRONT LOWER  
6 BLK<W9700> COMPRESSOR  
7 N/C  
8 BLK<W1700> FRONT TRAVEL  
9 N/C  
10 N/C  
11 WHT<W6254> GROUND  
12 N/C

AP27607<GRAY>  
PIN  
1 BLK<W6800> SW BATT  
2 BLK<W6800> SW BATT  
3 WHT<W6230> GND  
4 WHT<W6230> GND

AP27607<BLACK>  
PIN  
1 BLK<W5050> EXTEND CYL. ROOM 1  
2 BLK<W5150> RETRACT CYL ROOM 1  
3 BLK<W5051> EXTEND CYL. ROOM 2  
4 BLK<W5151> RETRACT CYL ROOM 2  
5 BLK<W5052> EXTEND CYL. ROOM 3  
6 BLK<W5152> RETRACT CYL ROOM 3  
7 N/C  
8 N/C  
9 N/C  
10 N/C  
11 N/C  
12 N/C

AP27665 CN9<BLACK>  
PIN  
1 BLK<W7696> SYSTEM WAKE UP  
2 N/C  
3 RED<W6800> SW BATT  
4 WHT<W6230> GROUND  
5 CAN SHIELD  
6 RED<W6110> IGNITION  
7 GRN CAN LOW  
8 YEL CAN HI

AP27665 CN10<GRAY>  
PIN  
1 BLK<W6807> ROOM SELECT SIGNAL  
2 BLK<W7510> READY TO OPERATE  
3 BLK<W7530> PUMP  
4 BLK<W7501> EXTEND <ROOM 1/ROOM 3>  
5 BLK<W7502> RETRACT <ROOM 1/ROOM 3>  
6 RED<W6805> SW BATTERY  
7 BLK<W7696> SYSTEM WAKE UP  
8 WHT<W6230> GROUND

AP27665 CN12<GRAY>  
PIN  
1 N/C  
2 N/C  
3 N/C  
4 N/C  
5 N/C  
6 WHT<W6236> GROUND  
7 BLK<W6800> SW BATT  
8 N/C  
9 N/C  
10 BLK<W2210> RIGHT FRONT AIR PSW  
11 BLK<W7521> TAG LIFT SW  
12 N/C

AP27665 CN11<GREEN>  
PIN  
1 N/C  
2 N/C  
3 N/C  
4 N/C  
5 N/C  
6 WHT<W6235> GROUND  
7 N/C  
8 N/C  
9 N/C  
10 BLK<W1210> LEFT FRONT AIR PSW  
11 N/C  
12 N/C

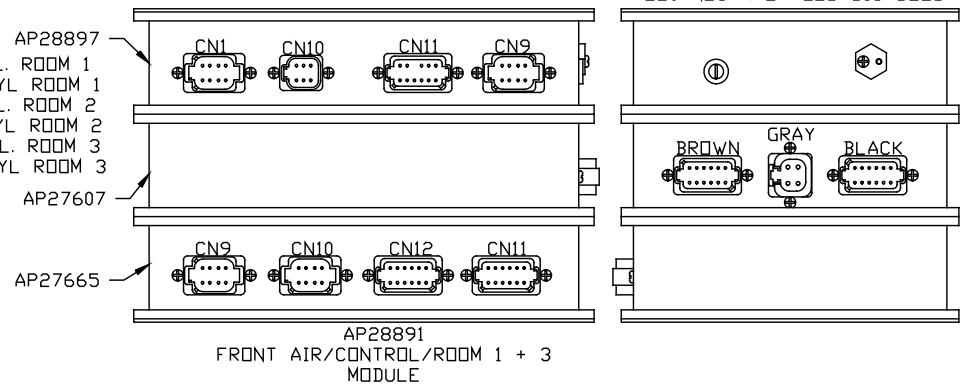

			HWH I-80 EXIT 267 SOUTH RT 1 MOSCOW, IOWA 52760		
2	28DEC05	UPDATED LED'S	SCALE 1:3	DATE 16SEP02	DRAWN BY .
1	26SEP05	ADDED 'P' SHEET	SYSTEM SCHEMATIC ELEC		
NO.	DATE	REVISION			
THE INFORMATION DISCLOSED ON THIS DRAWING IS CONFIDENTIAL AND MUST NOT BE DISCLOSED OR USED IN ANY MANNER WHICH WILL BE DETRIMENTAL TO THE HWH CORPORATION					DRAWING NUMBER MP88951 A/P

AP27623  
REAR AIR/ROOM 2 MODULE

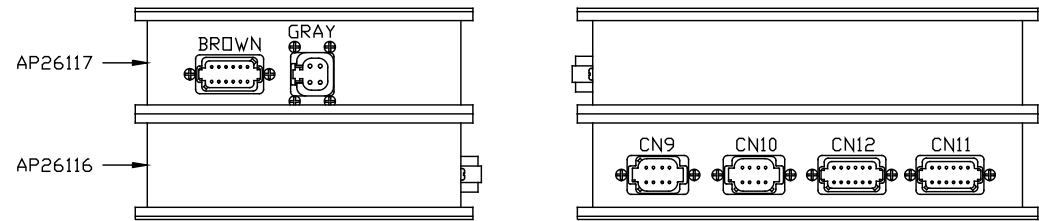

AP26117 (BROWN)  
PIN

- 1 BLK(W3800) TAG LIFT
- 2 BLK(W4500) LEFT REAR RAISE
- 3 BLK(W4600) LEFT REAR LOWER
- 4 BLK(W3500) RIGHT REAR RAISE
- 5 BLK(W3600) RIGHT REAR LOWER
- 6 N/C
- 7 BLK(W3701) TAG TRAVEL
- 8 BLK(W3700) REAR TRAVEL
- 9 BLK(W3601) TAG RIGHT DUMP
- 10 BLK(W4601) TAG LEFT DUMP
- 11 WHT (W6258) GROUND
- 12 N/C

AP26117 (GRAY)  
PIN

- 1 BLK(W6800) SW BATT
- 2 BLK(W6800) SW BATT
- 3 WHT(W6230) GROUND
- 4 WHT(W6230) GROUND

AP26116 CN9(BLACK)  
PIN

- 1 BLK(W7696) SYSTEM WAKE UP
- 2 N/C
- 3 RED(W6800) SW BATTERY
- 4 WHT(W6230) GROUND
- 5 CAN SHIELD
- 6 RED(W6110) IGNITION
- 7 GRN CAN LOW
- 8 YEL CAN HI

AP26116 CN10(GRAY)  
PIN

- 1 N/C
- 2 BLK(W7510) READY TO OPERATE
- 3 BLK(W7530) PUMP
- 4 BLK(W7501) EXTEND (ROOM 2)
- 5 BLK(W7502) RETRACT (ROOM 2)
- 6 RED(W6805) SW BATTERY
- 7 BLK(W7696) SYSTEM WAKE UP
- 8 WHT(W6230) GROUND

AP26116 CN12(GRAY)  
PIN

- 1 BLK(W4211) LEFT REAR TAG PRESS. SW.
- 2 BLK(W3211) RIGHT REAR TAG PRESS. SW.
- 3 BLK(W3215) SYSTEM PRESS. SW.
- 4 N/C
- 5 N/C
- 6 WHT(W6231) GROUND
- 7 N/C
- 8 N/C
- 9 N/C
- 10 N/C
- 11 N/C
- 12 N/C

AP26116 CN11(GREEN)  
PIN

- 1 N/C
- 2 BLK(W4210) LEFT REAR PRESS. SW.
- 3 BLK(W3210) RIGHT REAR PRESS. SW.
- 4 N/C
- 5 N/C
- 6 WHT(W6232) GROUND
- 7 N/C
- 8 N/C
- 9 N/C
- 10 N/C
- 11 N/C
- 12 N/C

AP22703

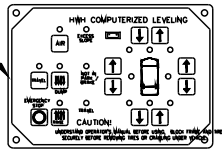

5 1

- PIN
- 1 YELLOW CAN HI
  - 2 GREEN CAN LOW
  - 3 CAN SHIELD
  - 4 GRN (W6230) GROUND
  - 5 RED (W6800) SW. BATTERY

120 OHM  
TERMINATION  
RESISTOR  
PART OF AP27720

AP27720

AP22475

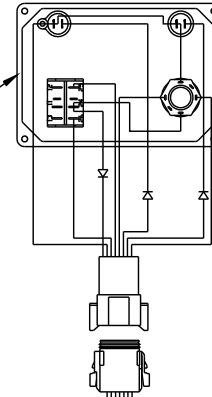

AP29274/AP22475

- PIN
- 1 N/C
  - 2 BLK(W7510) READY TO OPERATE
  - 3 BLK(W7530) PUMP
  - 4 BLK(W7501) ROOM EXTEND
  - 5 BLK(W7502) ROOM RETRACT
  - 6 RED(W6805) SW BATTERY
  - 7 BLK(W7631) SYSTEM WAKE UP
  - 8 WHT(W6230) GROUND

AP29274

RED(W6805) — [Switch Symbol] — RED(W6807)

ROOM SELECTOR SWITCH  
SUPPLIED BY COUNTRY COACH

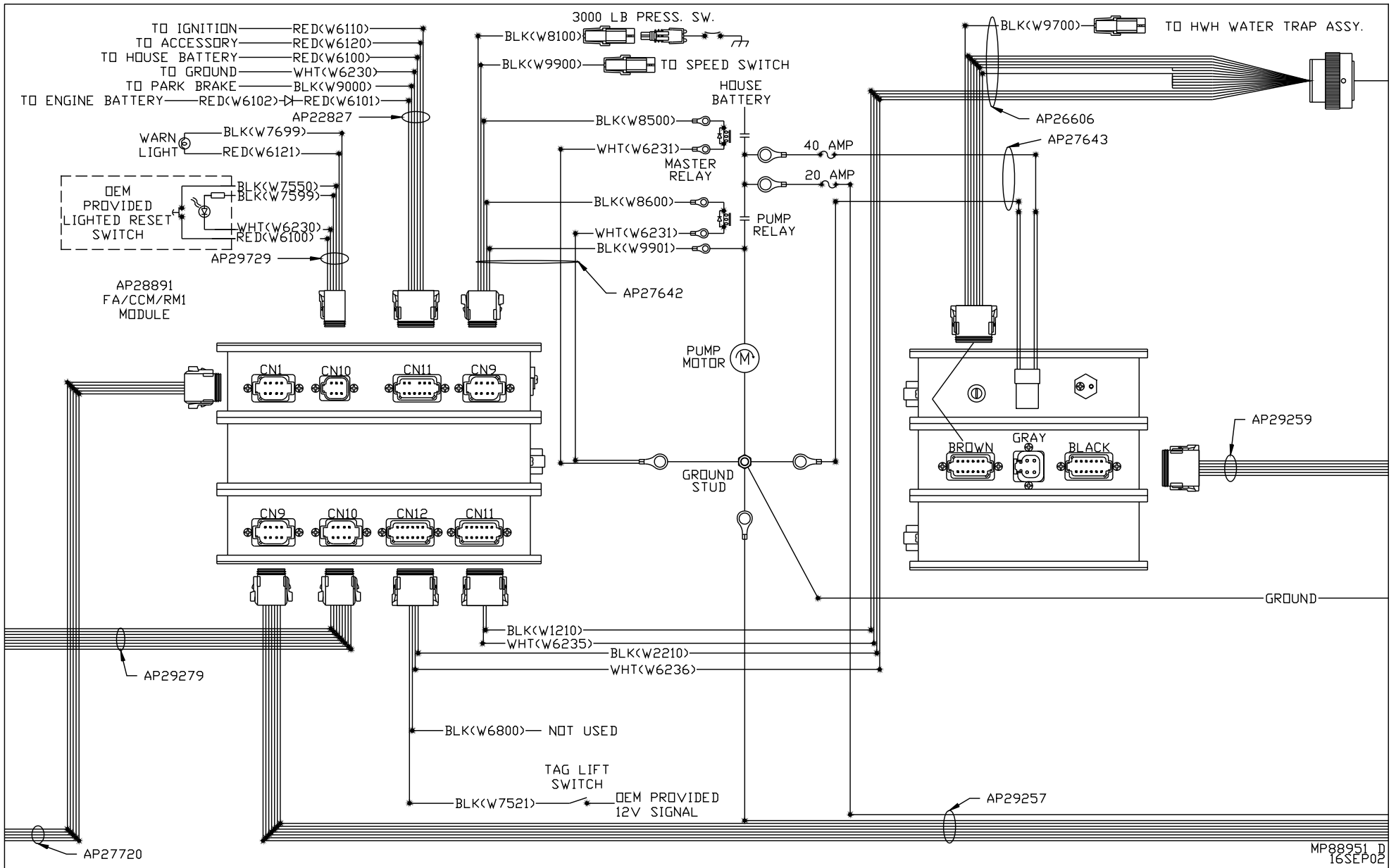

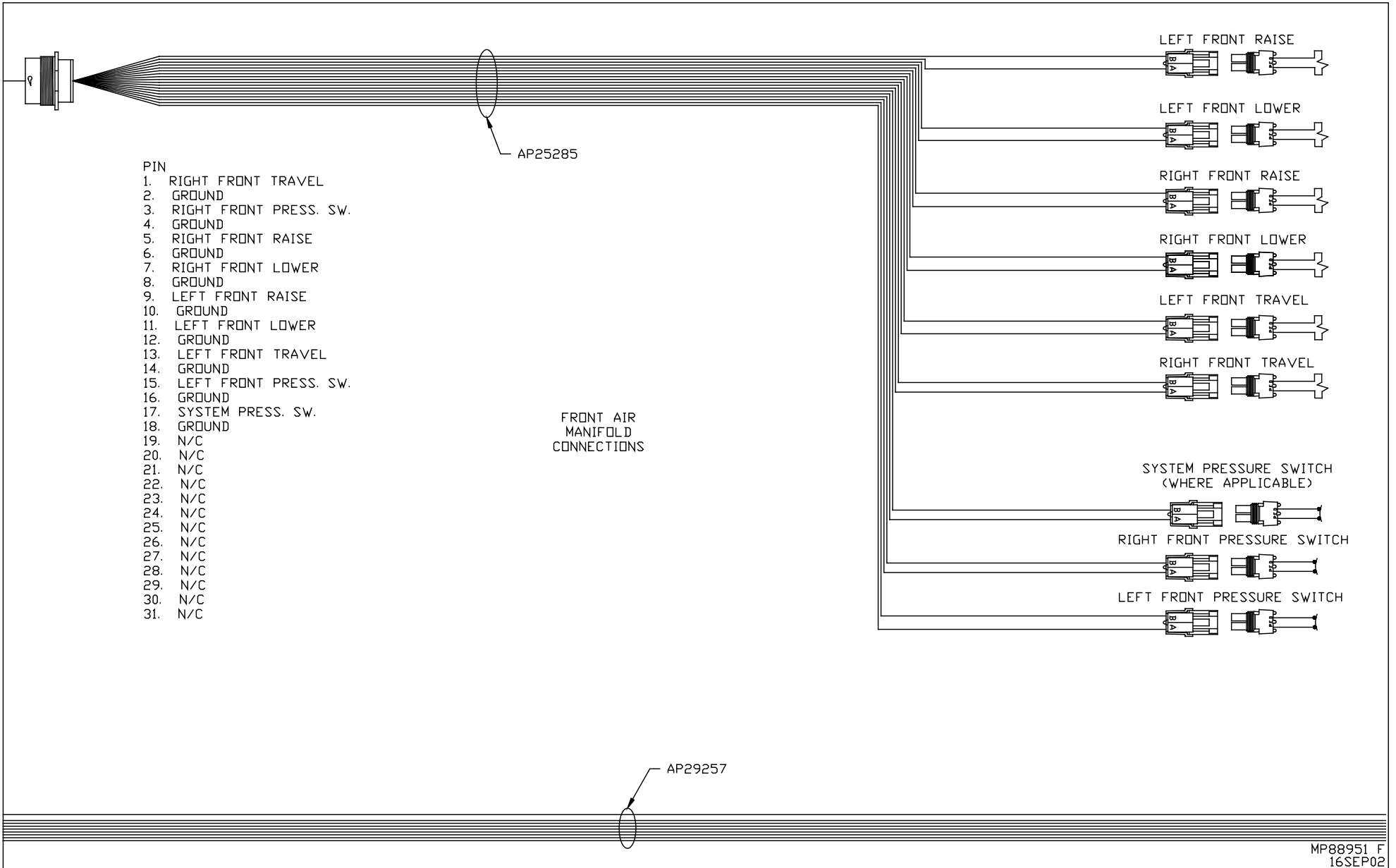

PIN

- 1. RIGHT FRONT TRAVEL
- 2. GROUND
- 3. RIGHT FRONT PRESS. SW.
- 4. GROUND
- 5. RIGHT FRONT RAISE
- 6. GROUND
- 7. RIGHT FRONT LOWER
- 8. GROUND
- 9. LEFT FRONT RAISE
- 10. GROUND
- 11. LEFT FRONT LOWER
- 12. GROUND
- 13. LEFT FRONT TRAVEL
- 14. GROUND
- 15. LEFT FRONT PRESS. SW.
- 16. GROUND
- 17. SYSTEM PRESS. SW.
- 18. GROUND
- 19. N/C
- 20. N/C
- 21. N/C
- 22. N/C
- 23. N/C
- 24. N/C
- 25. N/C
- 26. N/C
- 27. N/C
- 28. N/C
- 29. N/C
- 30. N/C
- 31. N/C

AP25285

FRONT AIR  
MANIFOLD  
CONNECTIONS

AP29257

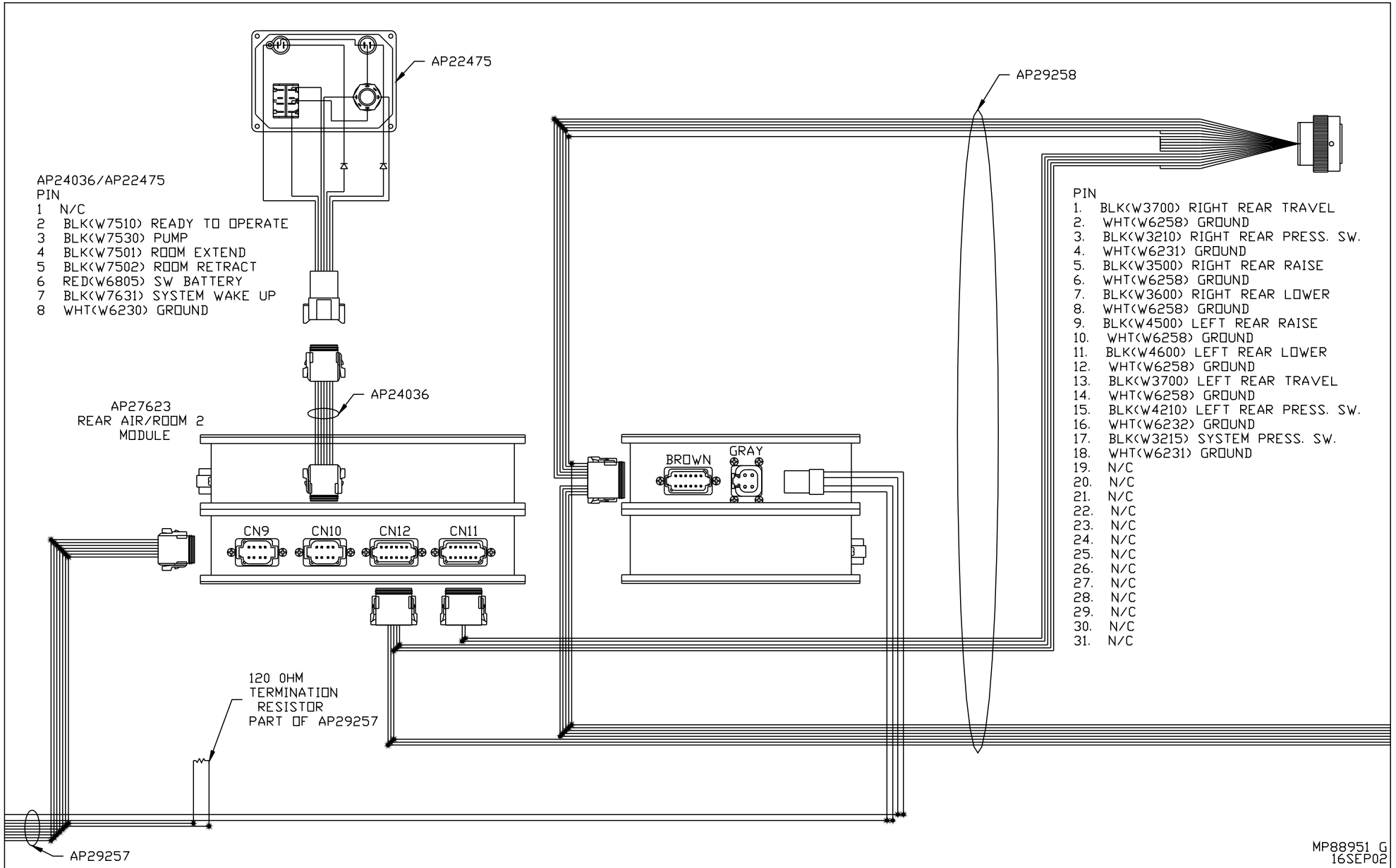



- PIN
1. RIGHT REAR TRAVEL
  2. GROUND
  3. RIGHT REAR PRESS. SW.
  4. GROUND
  5. RIGHT REAR RAISE
  6. GROUND
  7. RIGHT REAR LOWER
  8. GROUND
  9. LEFT REAR RAISE
  10. GROUND
  11. LEFT REAR LOWER
  12. GROUND
  13. LEFT REAR TRAVEL
  14. GROUND
  15. LEFT REAR PRESS. SW.
  16. GROUND
  17. SYSTEM PRESS. SW.
  18. GROUND
  19. N/C
  20. N/C
  21. N/C
  22. N/C
  23. N/C
  24. N/C
  25. N/C
  26. N/C
  27. N/C
  28. N/C
  29. N/C
  30. N/C
  31. N/C

AP25285

REAR AIR  
MANIFOLD  
CONNECTIONS

AP29258

LEFT REAR RAISE

LEFT REAR LOWER

RIGHT REAR RAISE

RIGHT REAR LOWER

LEFT REAR TRAVEL

RIGHT REAR TRAVEL

SYSTEM PRESSURE SWITCH

RIGHT REAR PRESSURE SWITCH

LEFT REAR PRESSURE SWITCH

PIN

- 1. TAG RIGHT SIDE TRAVEL
- 2. GROUND
- 3. TAG RIGHT SIDE PRESS. SW.
- 4. GROUND
- 5. TAG LIFT
- 6. GROUND
- 7. TAG RIGHT SIDE DUMP
- 8. GROUND
- 9. TAG LIFT EXHAUST
- 10. GROUND
- 11. TAG LEFT SIDE DUMP
- 12. GROUND
- 13. TAG LEFT SIDE TRAVEL
- 14. GROUND
- 15. TAG LEFT SIDE PRESS. SW.
- 16. GROUND
- 17. N/C
- 18. N/C
- 19. N/C
- 20. N/C
- 21. N/C
- 22. N/C
- 23. N/C
- 24. N/C
- 25. N/C
- 26. N/C
- 27. N/C
- 28. N/C
- 29. N/C
- 30. N/C
- 31. N/C

TAG AXLE  
AIR MANIFOLD  
CONNECTIONS

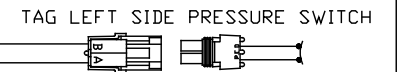
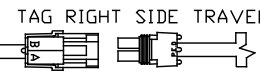
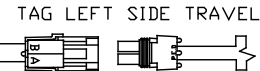
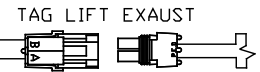
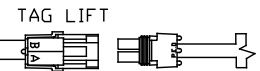
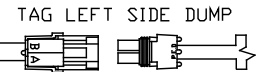
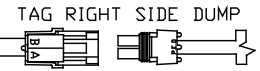
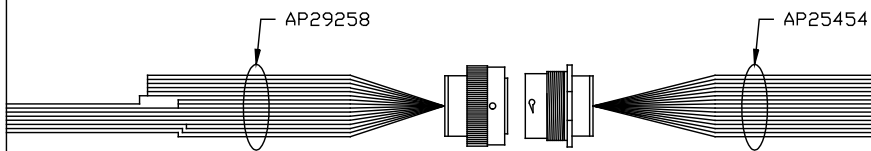



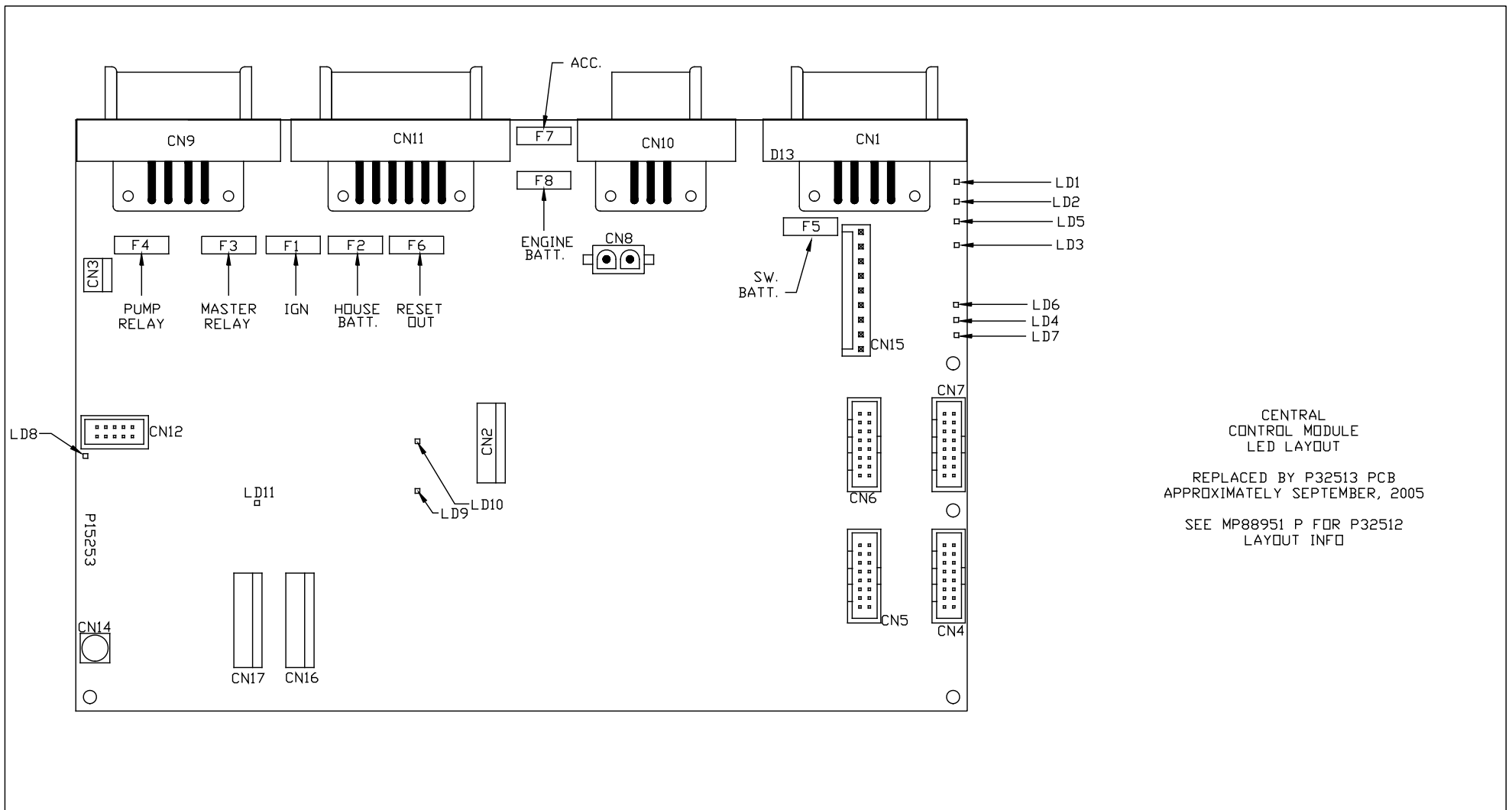

CENTRAL  
 CONTROL MODULE  
 LED LAYOUT  
 REPLACED BY P32513 PCB  
 APPROXIMATELY SEPTEMBER, 2005  
 SEE MP88951 P FOR P32512  
 LAYOUT INFO

LED #	CONNECTOR	COLOR	DESCRIPTION
LED 1	CN 9 PIN 1	RED	MASTER RELAY
LED 2	CN 9 PIN 4	RED	PUMP RELAY
LED 3	CN 1 PIN 3	RED	SW 12V
LED 4	CN 11 PIN 12	RED	ENGINE BATT
LED 5	CN 9 PIN 5	RED	SPEED SWITCH
LED 6	NOT USED	NOT USED	NOT USED

LED #	CONNECTOR	COLOR	DESCRIPTION
LED 7	CN 1 PIN 7 & 8	RED	LINK LIGHT
LED 8	NOT USED	NOT USED	NOT USED
LED 9	NOT USED	NOT USED	NOT USED
LED 10	CN9 PIN 2	RED	3000 LBS. PSW
LED 11	CN11 PIN 11	RED	PARK BRAKE

MP88951 J  
28DEC05

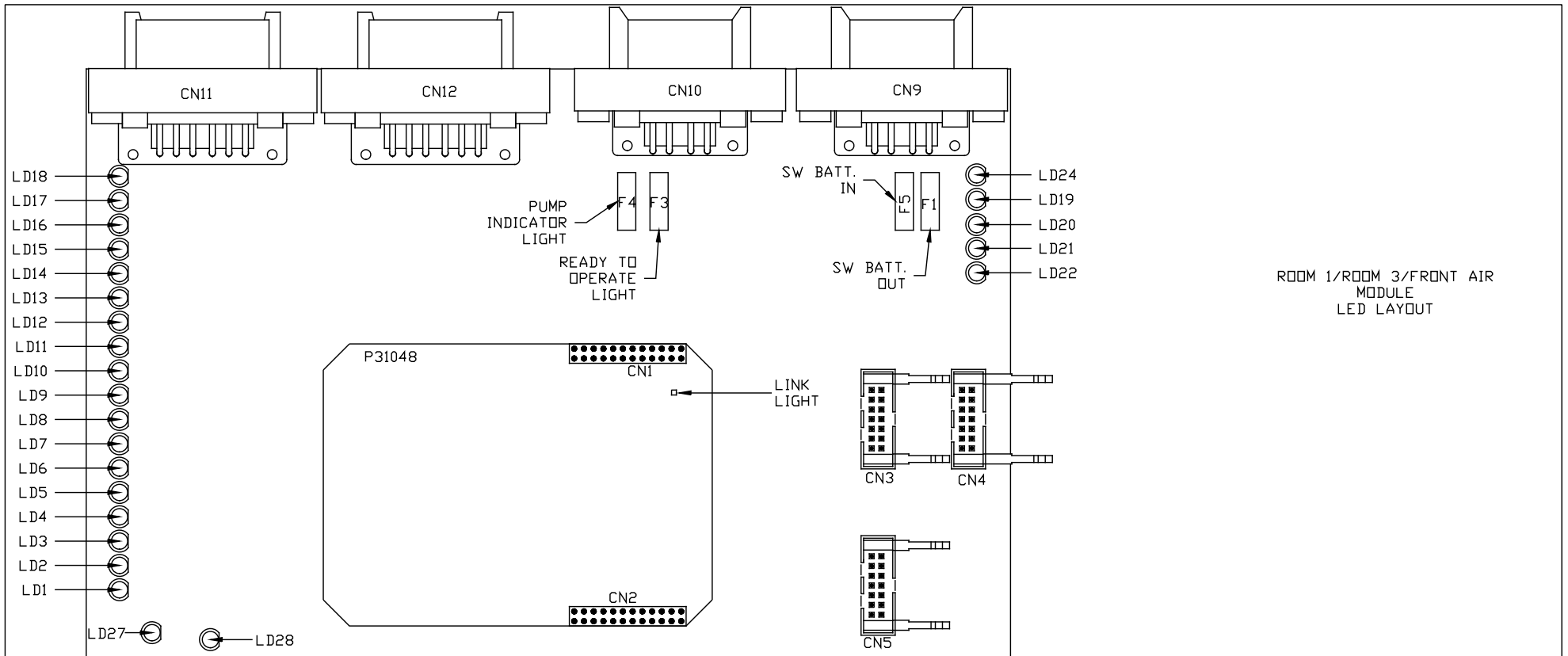

ROOM 1/ROOM 3/FRONT AIR  
MODULE  
LED LAYOUT

LED #	CONNECTOR	COLOR	DESCRIPTION	LED #	CONNECTOR	COLOR	DESCRIPTION
LED 1	CN10 PIN 4	RED	EXTEND	LED 16	NOT USED	GREEN	NOT USED
LED 2	CN10 PIN 5	RED	RETRACT	LED 17	NOT USED	GREEN	NOT USED
LED 3	NOT USED	GREEN	NOT USED	LED 18	NOT USED	GREEN	NOT USED
LED 4	NOT USED	YELLOW	NOT USED	LED 19	CN11/CN12 PIN 7	RED	12V OUTPUT
LED 5	NOT USED	YELLOW	NOT USED	LED 20	CN9 PIN 3	RED	SW BATT
LED 6	NOT USED	YELLOW	NOT USED	LED 21	CN10 PIN 3	RED	PUMP INDICATOR
LED 7	NOT USED	GREEN	NOT USED	LED 22	CN10 PIN 2	RED	READY TO OPERATE
LED 8	NOT USED	GREEN	NOT USED	LED 24	CN10 PIN 7	RED	SYSTEM WAKE UP
LED 9	CN11 PIN 10	GREEN	LEFT FRONT PSW	LED 27	NOT USED	RED	NOT USED
LED 10	CN12 PIN 10	GREEN	RIGHT FRONT PSW	LED 28	CN 12 PIN 11	RED	TAG LIFT SWITCH
LED 11	NOT USED	YELLOW	NOT USED				
LED 12	NOT USED	YELLOW	NOT USED				
LED 13	NOT USED	YELLOW	NOT USED				
LED 14	CN10 PIN 1	YELLOW	ROOM SELECT SIGNAL				
LED 15	NOT USED	GREEN	NOT USED				

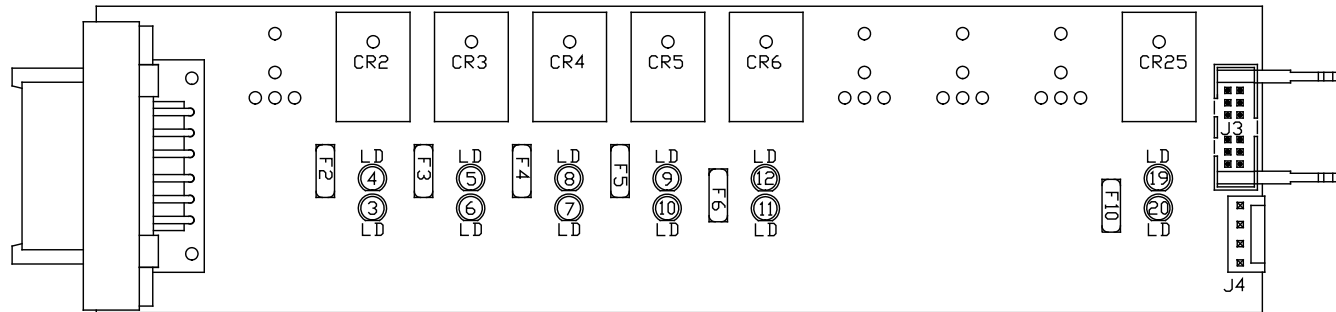

FRONT AIR  
LED LAYOUT

LED #	COLOR	INPUT J3	FUSE #	OUTPUT	RELAY #	DESCRIPTION
LED1	---	---	---	---	---	---
LED2	---	---	---	---	---	---
LED3	RED	---	FUSE 2	PIN 2	CR2	LEFT FRONT RAISE (CONTACT)
LED4	YELLOW	PIN 12	---	---	CR2	LEFT FRONT RAISE (COIL)
LED5	YELLOW	PIN 11	---	---	CR3	LEFT FRONT LOWER (COIL)
LED6	RED	---	FUSE 3	PIN 3	CR3	LEFT FRONT LOWER (CONTACT)
LED7	RED	---	FUSE 4	PIN 4	CR4	RIGHT FRONT RAISE (CONTACT)
LED8	YELLOW	PIN 10	---	---	CR4	RIGHT FRONT RAISE (COIL)
LED9	YELLOW	PIN 9	---	---	CR5	RIGHT FRONT LOWER (COIL)
LED10	RED	---	FUSE 5	PIN 5	CR5	RIGHT FRONT LOWER (CONTACT)
LED11	RED	---	FUSE 6	PIN 6	CR6	COMPRESSOR (CONTACT)
LED12	YELLOW	PIN 8	---	---	CR6	COMPRESSOR (COIL)
LED13	---	---	---	---	---	---
LED14	---	---	---	---	---	---
LED15	---	---	---	---	---	---
LED16	---	---	---	---	---	---
LED17	---	---	---	---	---	---
LED18	---	---	---	---	---	---
LED19	YELLOW	PIN 4	---	---	CR25	TRAVEL (COIL)
LED20	RED	---	FUSE 10	PIN 8	CR25	TRAVEL (CONTACT)

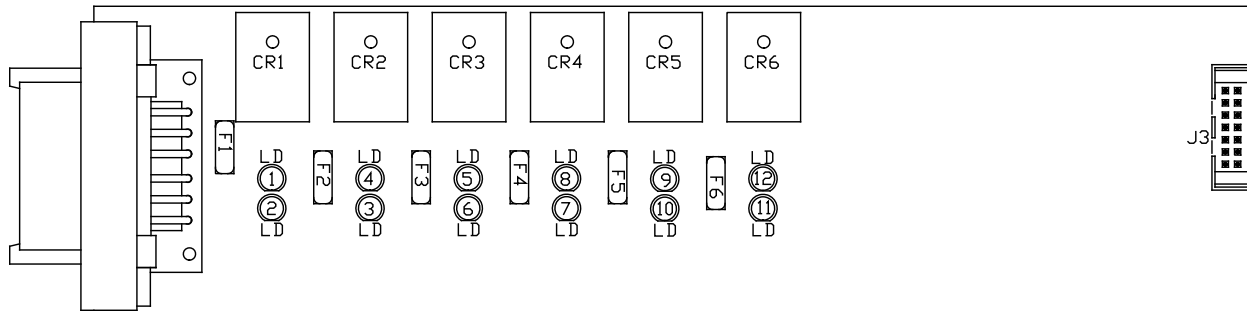

OUTPUT BOARD  
LED LAYOUT

LED #	COLOR	INPUT J3	FUSE #	OUTPUT	RELAY #	DESCRIPTION
LED1	YELLOW	PIN 13	---	---	CR1	CYL EXTEND 1 (COIL)
LED2	RED	---	FUSE 1	PIN 1	CR1	CYL EXTEND 1 (CONTACT)
LED3	RED	---	FUSE 2	PIN 2	CR2	CYL RETRACT 1 (CONTACT)
LED4	YELLOW	PIN 12	---	---	CR2	CYL RETRACT 1 (COIL)
LED5	YELLOW	PIN 11	---	---	CR3	CYL EXTEND 2 (COIL)
LED6	RED	---	FUSE 3	PIN 3	CR3	CYL EXTEND 2 (CONTACT)
LED7	RED	---	FUSE 4	PIN 4	CR4	CYL RETRACT 2 (CONTACT)
LED8	YELLOW	PIN 10	---	---	CR4	CYL RETRACT 2 (COIL)
LED9	YELLOW	PIN 9	---	---	CR5	CYL EXTEND 3 (COIL)
LED10	RED	---	FUSE 5	PIN 5	CR5	CYL EXTEND 3 (CONTACT)
LED11	RED	---	FUSE 6	PIN 6	CR6	CYL RETRACT 3 (CONTACT)
LED12	YELLOW	PIN 8	---	---	CR6	CYL RETRACT 3 (COIL)
LED13	RED	---	---	---	---	---
LED14	YELLOW	---	---	---	---	---
LED15	YELLOW	---	---	---	---	---
LED16	RED	---	---	---	---	---
LED17	YELLOW	---	---	---	---	---
LED18	RED	---	---	---	---	---
LED19	YELLOW	---	---	---	---	---
LED20	RED	---	---	---	---	---

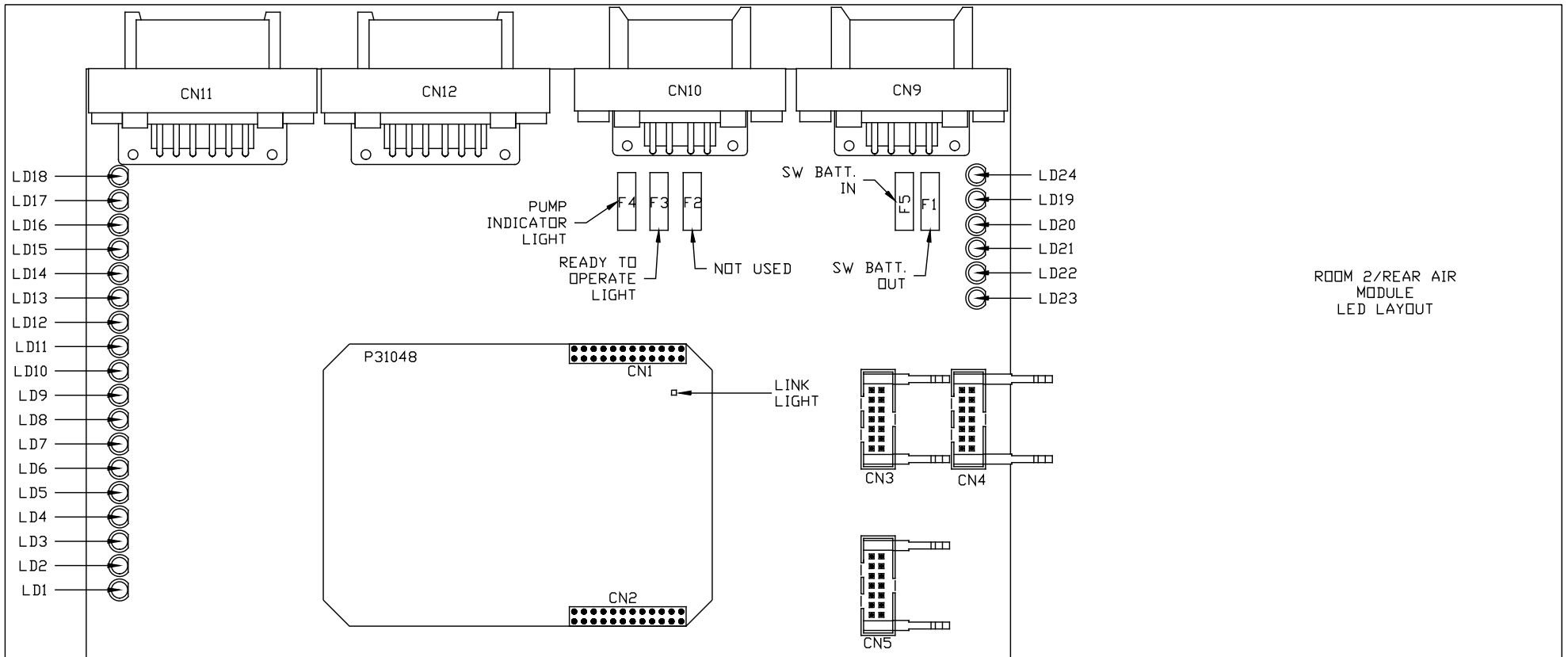

LED #	CONNECTOR	COLOR	DESCRIPTION	LED #	CONNECTOR	COLOR	DESCRIPTION
LED 1	CN10 PIN 4	RED	EXTEND	LED 16	NOT USED	GREEN	NOT USED
LED 2	CN10 PIN 5	RED	RETRACT	LED 17	NOT USED	GREEN	NOT USED
LED 3	NOT USED	GREEN	NOT USED	LED 18	NOT USED	GREEN	NOT USED
LED 4	NOT USED	YELLOW	NOT USED	LED 19	CN11/CN12 PIN 7	RED	12V OUTPUT
LED 5	CN11 PIN 2	YELLOW	LEFT REAR PRESS SW.	LED 20	CN9 PIN 3	RED	SW BATT
LED 6	CN12 PIN 2	YELLOW	RIGHT REAR TAG PRESS SW.	LED 21	CN10 PIN 3	RED	PUMP INDICATOR
LED 7	CN11 PIN 3	GREEN	RIGHT REAR PRESS SW.	LED 22	CN10 PIN 2	RED	READY TO OPERATE
LED 8	CN12 PIN 3	GREEN	SYSTEM PRESS SW.	LED 23	NOT USED	RED	NOT USED
LED 9	NOT USED	GREEN	NOT USED	LED 24	CN10 PIN 7	RED	SYSTEM WAKE UP
LED 10	NOT USED	GREEN	NOT USED				
LED 11	NOT USED	YELLOW	NOT USED				
LED 12	CN12 PIN 1	YELLOW	LEFT REAR TAG PRESS SW.				
LED 13	NOT USED	YELLOW	NOT USED				
LED 14	NOT USED	YELLOW	NOT USED				
LED 15	NOT USED	GREEN	NOT USED				

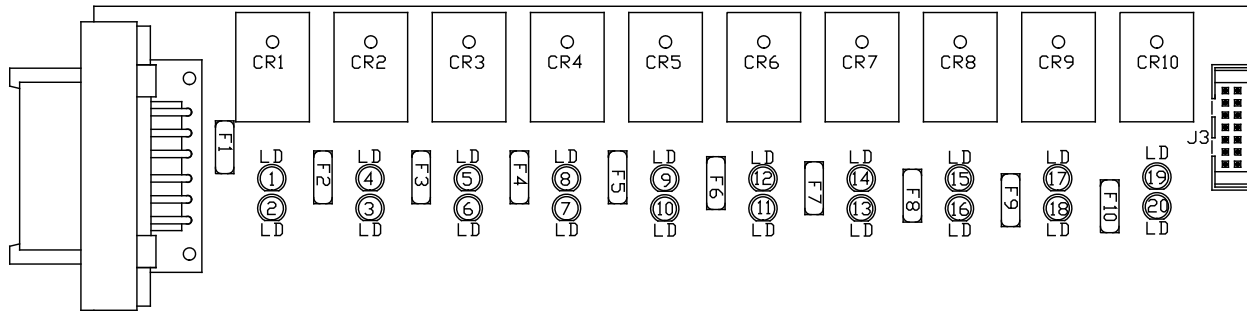

REAR AIR  
LED LAYOUT

LED #	COLOR	INPUT J3	FUSE #	OUTPUT	RELAY #	DESCRIPTION
LED1	YELLOW	PIN 13	---	---	CR1	TAG LIFT (COIL)
LED2	RED	---	FUSE 1	PIN 1	CR1	TAG LIFT (CONTACT)
LED3	RED	---	FUSE 2	PIN 2	CR2	LEFT REAR RAISE (CONTACT)
LED4	YELLOW	PIN 12	---	---	CR2	LEFT REAR RAISE (COIL)
LED5	YELLOW	PIN 11	---	---	CR3	LEFT REAR LOWER (COIL)
LED6	RED	---	FUSE 3	PIN 3	CR3	LEFT REAR LOWER (CONTACT)
LED7	RED	---	FUSE 4	PIN 4	CR4	RIGHT REAR RAISE (CONTACT)
LED8	YELLOW	PIN 10	---	---	CR4	RIGHT REAR RAISE (COIL)
LED9	YELLOW	PIN 9	---	---	CR5	RIGHT REAR LOWER (COIL)
LED10	RED	---	FUSE 5	PIN 5	CR5	RIGHT REAR LOWER (CONTACT)
LED11	RED	---	FUSE 6	PIN 6	CR6	NOT USED
LED12	YELLOW	PIN 8	---	---	CR6	NOT USED
LED13	RED	---	FUSE 7	PIN 10	CR7	TAG LEFT REAR LOWER (CONTACT)
LED14	YELLOW	PIN 7	---	---	CR7	TAG LEFT REAR LOWER (COIL)
LED15	YELLOW	PIN 6	---	---	CR8	TAG RIGHT REAR LOWER (COIL)
LED16	RED	---	FUSE 8	PIN 9	CR8	TAG RIGHT REAR LOWER (CONTACT)
LED17	YELLOW	PIN 5	---	---	CR9	TAG TRAVEL (COIL)
LED18	RED	---	FUSE 9	PIN 7	CR9	TAG TRAVEL (CONTACT)
LED19	YELLOW	PIN 4	---	---	CR10	TRAVEL (COIL)
LED20	RED	---	FUSE 10	PIN 8	CR10	TRAVEL (CONTACT)

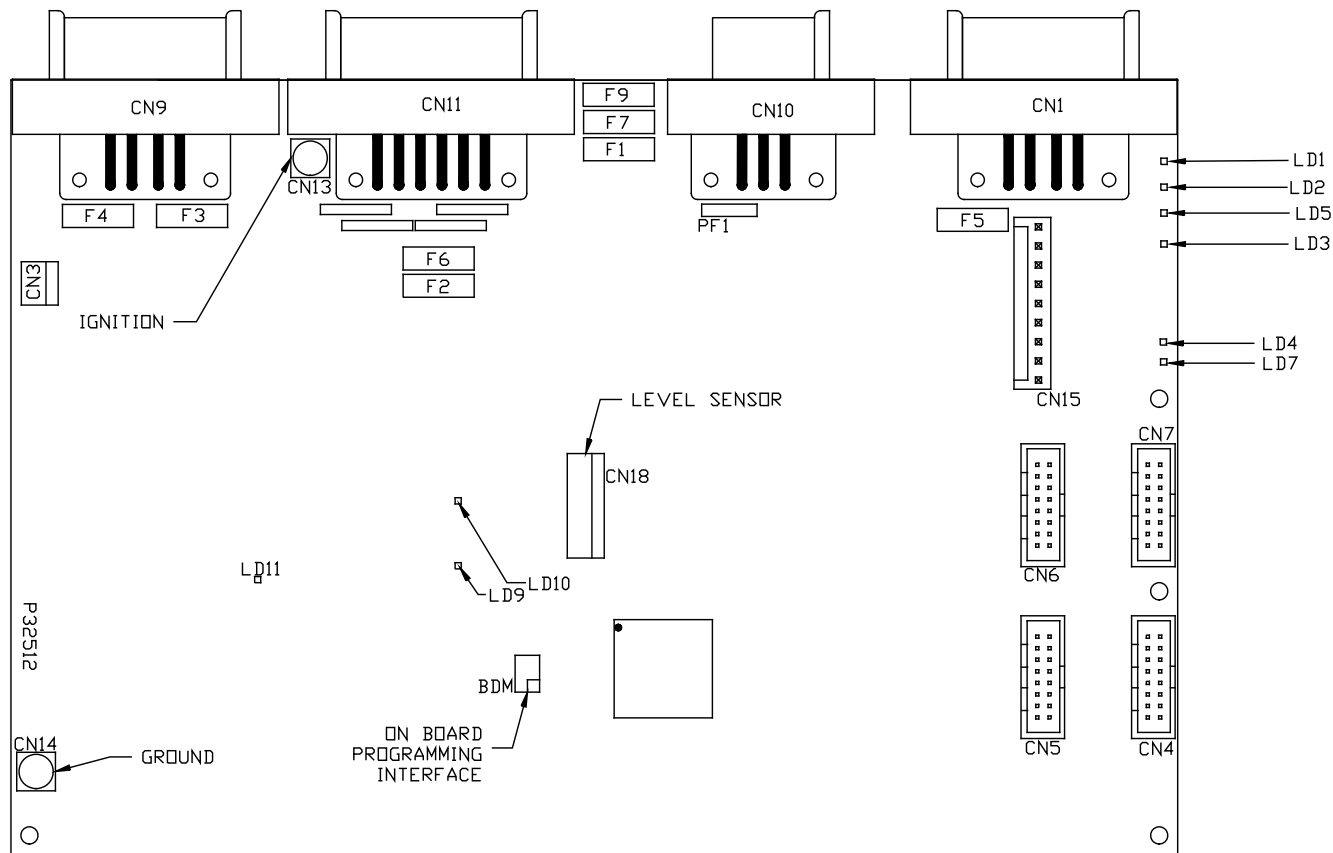

CENTRAL  
CONTROL MODULE  
LED LAYOUT  
EFFECTIVE APPROXIMATELY  
SEPTEMBER, 2005

LED #	CONNECTOR	COLOR	DESCRIPTION
LED 1	CN 9 PIN 1	RED	MASTER RELAY
LED 2	CN 9 PIN 4	RED	PUMP RELAY
LED 3	CN 1 PIN 3	RED	SW 12V
LED 4	CN 11 PIN 12	RED	ENGINE BATT
LED 5	CN 9 PIN 5	RED	SPEED SWITCH
LED 7	CN 1 PIN 7 & 8	RED	LINK LIGHT
LED 8	NOT USED	RED	NOT USED
LED 9	NOT USED	RED	NOT USED
LED 10	CN9 PIN 2	RED	3000 LBS. PSW
LED 11	CN11 PIN 11	RED	PARK BRAKE

FUSE #	DESCRIPTION
PF1	RESET OUT
F7	ACCESSORY
F1	IGNITION
F2	HOUSE BATTERY
F3	MASTER RELAY
F4	PUMP RELAY
F5	SW. BATT TO CAN MODULES
F6	ENGINE BATTERY
F9	NOT USED