

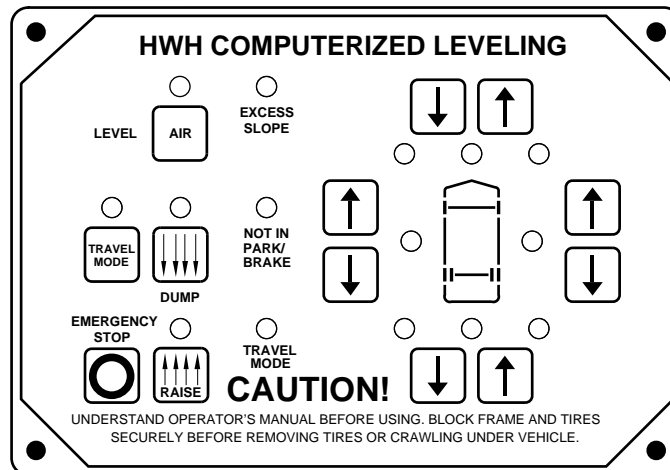

# OPERATOR'S MANUAL

## HWH® COMPUTER-CONTROLLED 2000 SERIES LEVELING SYSTEM AND SPACEMAKER® ROOM EXTENSION SYSTEMS

**FEATURING:**  
*Touch Panel Leveling Control*  
*Air Leveling (With Tag Axle)*  
*Three Room Extensions*



**HWH CORPORATION**  
(On I-80, Exit 267 South)  
2096 Moscow Road | Moscow, Iowa 52760  
Ph: 800/321-3494 (or) 563/724-3396 | Fax: 563/724-3408  
[www.hwh.com](http://www.hwh.com)

---

# OPERATOR'S MANUAL

---

## CAUTION !

READ THE ENTIRE OPERATOR'S MANUAL BEFORE OPERATING.

BLOCK FRAME AND TIRES SECURELY BEFORE CRAWLING UNDER VEHICLE. DO NOT USE LEVELING JACKS OR AIR SUSPENSION TO SUPPORT VEHICLE WHILE UNDER VEHICLE OR CHANGING TIRES. VEHICLE MAY DROP AND/OR MOVE FORWARD OR BACKWARD WITHOUT WARNING CAUSING INJURY OR DEATH.

KEEP ALL PEOPLE CLEAR OF VEHICLE WHILE LEVELING SYSTEM AND ROOM EXTENSION ARE BEING OPERATED.

NEVER PLACE HANDS OR OTHER PARTS OF THE BODY NEAR HYDRAULIC LEAKS. OIL MAY PENETRATE SKIN CAUSING INJURY OR DEATH.

DO NOT OPERATE THE LEVELING SYSTEM OR USE THE DUMP OR RAISE BUTTONS IF THE VEHICLE IS MOVING IN EXCESS OF 5 MPH.

WEAR SAFETY GLASSES WHEN INSPECTING OR SERVICING THE SYSTEM TO PROTECT EYES FROM DIRT, METAL CHIPS, OIL LEAKS, ETC. FOLLOW ALL OTHER APPLICABLE SHOP SAFETY PRACTICES.

IMPORTANT: IF COACH IS EQUIPPED WITH A ROOM EXTENSION, READ ROOM EXTENSION SECTION BEFORE OPERATING LEVELING SYSTEM.

## HOW TO OBTAIN WARRANTY SERVICE

### THIS IS NOT TO BE INTERPRETED AS A STATEMENT OF WARRANTY

HWH CORPORATION strives to maintain the highest level of customer satisfaction. Therefore, if you discover a defect or problem, please do the following:

**FIRST:** Notify the dealership where you purchased the vehicle or had the leveling system installed. Dealership management people are in the best position to resolve the problem quickly. If the dealer has difficulty solving the problem, he should immediately contact the Customer Service Department, at HWH CORPORATION.

**SECOND:** If your dealer cannot or will not solve the problem, notify the Customer Service Department:  
HWH CORPORATION 2096 Moscow Rd. Moscow IA. 52760  
(563) 724-3396 OR (800) 321-3494. Give your name and address, coach manufacturer and model year, date the coach was purchased, or the date of system installation,

description of the problem, and where you can be reached during business hours (8:00 a.m. till 5:00 p.m. c.s.t.). HWH CORPORATION personnel will contact you to determine whether or not your claim is valid. If it is, HWH CORPORATION will authorize repair or replacement of the defective part, either by appointment at the factory or by the authorization of an independent service facility, to be determined by HWH CORPORATION. All warranty repairs must be performed by an independent service facility authorized by HWH CORPORATION, or at the HWH CORPORATION factory, unless prior written approval has been obtained from proper HWH CORPORATION personnel.

# CONTROL IDENTIFICATION

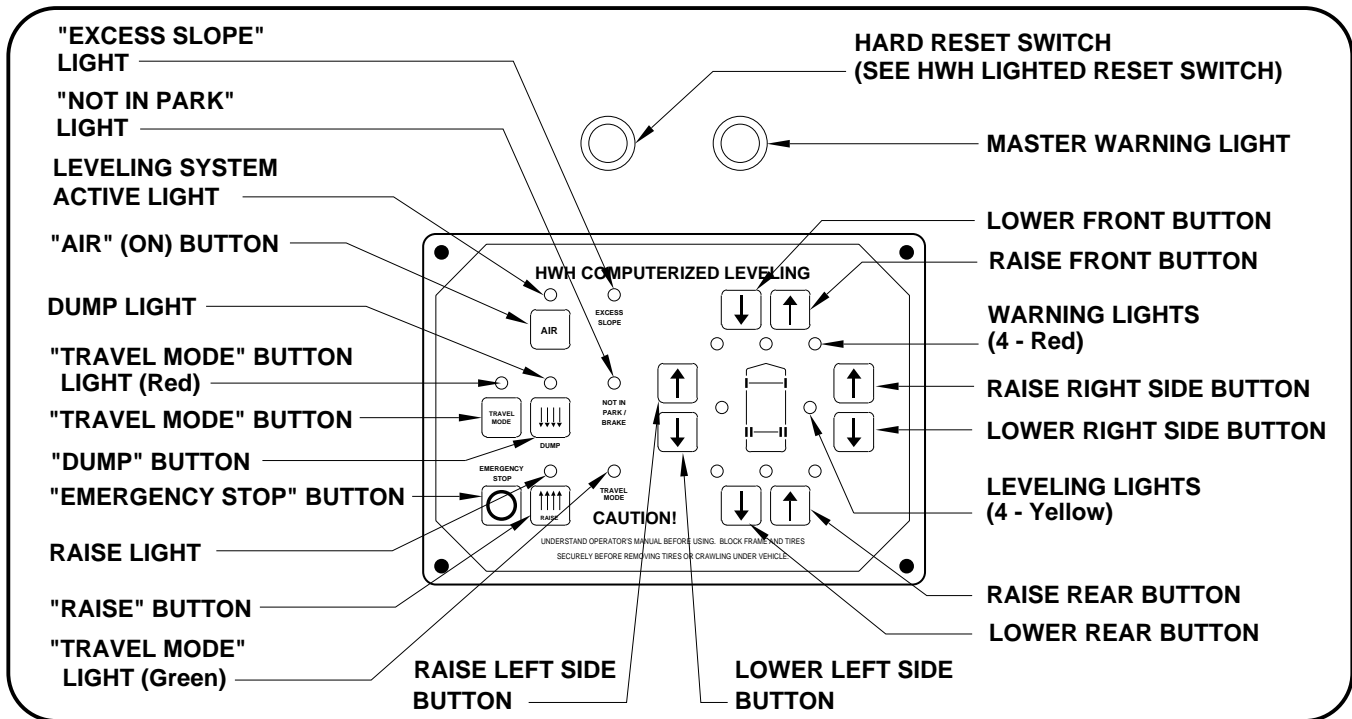

## CONTROL FUNCTIONS

### CONTROL BUTTONS

**"AIR" BUTTON:** This is the system active and automatic operation button. It works if the ignition is in the "ON" position.

**"EMERGENCY STOP" BUTTON:** This button turns the system OFF but does NOT control power to the "DUMP" or "RAISE" buttons. Pushing this button will NOT put the system in the TRAVEL mode.

**"TRAVEL MODE" BUTTON:** This button will put the Leveling System in the TRAVEL mode. The ignition must be "ON" for the vehicle to return to proper ride height for traveling.

**"DUMP" BUTTON:** This button will lower the whole coach by dumping air from the suspension system.

**"RAISE" BUTTON:** This button will raise the whole coach by adding air to the suspension system.

**IMPORTANT:** Read "DUMP AND RAISE FUNCTIONS" before using the "DUMP" or "RAISE" buttons.

**UP ARROWS (RAISE BUTTONS):** These momentary buttons are used for manually operating the air leveling systems. Sides or ends of the vehicle will raise while these buttons are pushed.

**DOWN ARROWS (LOWER BUTTONS):** These momentary buttons are used for manually operating the air leveling systems. Sides or ends of the vehicle will lower while these buttons are pushed.

### INDICATOR LIGHTS

**LEVEL SYSTEM ACTIVE LIGHT:** ON when the system is active, and flashes during automatic leveling.

**DUMP LIGHT:** Flashes when "DUMP" button is pushed.

**RAISE LIGHT:** Flashes when "RAISE" button is pushed.

**"EXCESS SLOPE" LIGHT:** ON if the leveling system can NOT level the coach.

**"TRAVEL MODE" BUTTON LIGHT (RED):** Light flashes for 3 seconds after the "TRAVEL MODE" button is pushed.

**"TRAVEL MODE" LIGHT (GREEN):** ON if the ignition is in the "ON" position, the system is not being used, and there is sufficient air pressure in the suspension. See PREPARATION FOR TRAVEL.

**WARNING LIGHTS:** Function with the ignition in the "ON" position. ON when the LEVELING SYSTEM ACTIVE LIGHT is ON. See PREPARATION FOR TRAVEL.

**LEVELING LIGHTS:** One or two yellow lights can be on indicating the side, end or corner of the coach is low.

**"NOT IN PARK/BRAKE" LIGHT:** ON while the "AIR" button is being pushed if the Park Brake is NOT set. The light will go out when the "AIR" button is released.

**MASTER WARNING LIGHT:** ON any time the "TRAVEL" light is not ON, if the ignition is in the "ON" position.

## CONTROL IDENTIFICATION

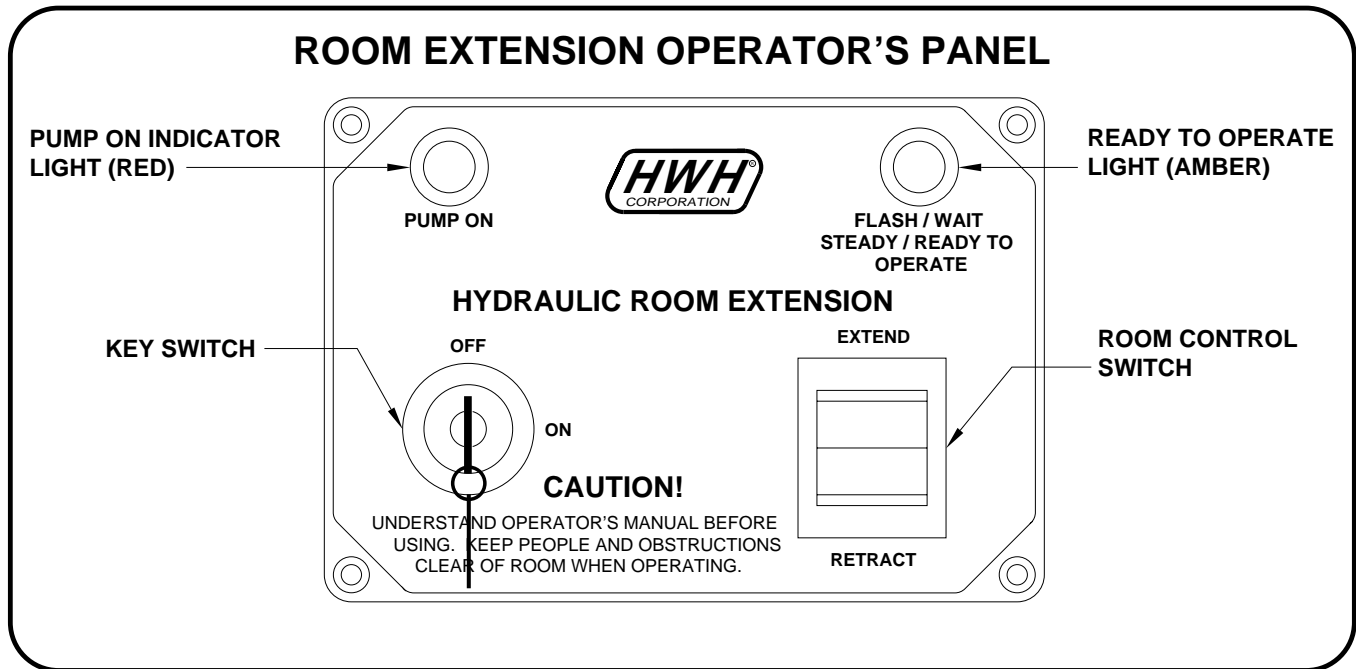

## CONTROL FUNCTIONS

**KEY SWITCH:** The KEY SWITCH controls power to the ROOM CONTROL SWITCH. When the KEY SWITCH is in the "ON" POSITION the room can be operated, and the key cannot be removed. When the KEY SWITCH is in the "OFF" position the room cannot be operated, and the key can be removed.

**NOTE:** Any time the KEY SWITCH is ON, the network will be active and will not power down.

**ROOM CONTROL SWITCH:** The ROOM CONTROL SWITCH is a two position momentary switch. Pressing the switch in the EXTEND POSITION will extend the room. Pressing the switch in the RETRACT POSITION will retract the room. Releasing the ROOM CONTROL SWITCH will halt the operation of the room.

**PUMP ON INDICATOR LIGHT:** This light will be on when the pump is running.

**READY TO OPERATE LIGHT:** After the KEY SWITCH is turned on the READY TO OPERATE LIGHT will glow steady. Except for EXCESS SLOPE situations, the room cannot be extended or retracted if this light is flashing.

If the "EXCESS SLOPE" light on the leveling system control panel is on, the READY TO OPERATE light will flash continuously after the key switch is turned ON. The room will not extend. The room will retract if the room control switch is pushed to "RETRACT".

If the PARK BRAKE is not set, the READY TO OPERATE light will not turn on and flash when the KEY SWITCH is turned "ON".

If a RAISE or LOWER function of the Leveling System is in use, MANUAL or AUTOMATIC operation, the READY TO OPERATE light will flash if the KEY SWITCH is in the "ON" position. The room will not operate.

## MASTER WARNING LIGHT

This light is on the dash, separate from the control panels. It can be on only if the ignition key is in the "ON" position.

The light will be on if a HWH low air pressure switch is on, if the Leveling System is on, or if the Leveling System is not in the TRAVEL mode.

---

# CONTROL IDENTIFICATION

## PUMP RUN TIME

---

### PUMP RUN TIME

Pump motors used with HWH leveling systems and room extension systems come in 3 different diameters; 3", 3.7" and 4.5". Contact the vehicle manufacturer or HWH for help with identifying the motor size. **It is important that any time the pump runs for more than three minutes with a 3" motor; or six minutes with a 3.7" or 4.5" motor that the motor is allowed to cool for thirty minutes before continuing. Continuous operation of the pump motor without allowing the motor to cool can damage the motor.** For cold weather information see "COLD WEATHER OPERATIONS" below.

The HWH systems with a computer processor monitor the pump run time and will turn the pump off if the run time exceeds a specified time. This time can vary with different systems. Due to available electronics or system design, the pump run time programs will also vary. Leveling systems and room extensions that are not controlled by a system processor have no pump run time protection. **DO NOT run the pump more than three or six minutes without allowing the pump motor to cool for thirty minutes.**

#### SYSTEM VARIATIONS FOR PUMP RUN TIME

Some systems with rooms run the rooms separate from the system processor. These systems do not monitor pump run time when operating the rooms. **DO NOT run the pump more than three or six minutes without allowing the pump motor to cool for thirty minutes.**

Some systems can be turned back on immediately after the processor turns the pump off. **DO NOT turn the system back on or run the pump without allowing the pump motor to cool for thirty minutes.**

When operating some leveling systems manually or operating the room extensions, the pump will turn off and back on while pushing the control button when the pump run time has been exceeded. **DO NOT continue without allowing the pump motor to cool for thirty minutes.**

With some systems, when the processor has turned the pump off because the run time has been exceeded, power to the HWH system must be turned off and back on before the system will operate. With motorized vehicles, turn the ignition off and back on. With non-motorized vehicles, turn the master power switch for the HWH system off and back on. **DO NOT continue without allowing the pump motor to cool for thirty minutes.**

Some HWH systems are equipped with a lighted reset switch. If the processor turns the pump off because the run time has been exceeded, the light in the reset switch will turn on. The system will not operate until the reset switch is pushed.

**DO NOT continue without allowing the pump motor to cool for thirty minutes.**

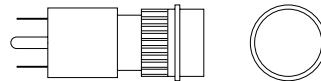

LIGHTED RESET SWITCH

**No matter what HWH system is on the vehicle, the pump should not be ran for more than three minutes (3" motors) or six minutes (3.7" or 4.5" motors) without allowing the pump motor to cool for thirty minutes. Continuous operation of the pump motor without allowing the motor to cool can damage the pump motor.**

Contact HWH corporation to get specific information about the system in this vehicle.

## COLD WEATHER OPERATIONS

HWH leveling and room extension systems are designed to function in cold weather down to 0 degrees Fahrenheit. Below freezing (32 degrees Fahrenheit) the jacks or rooms will operate slower than usual.

For operation in temperatures dropping below -20 degrees Fahrenheit, it is necessary that the system is equipped with oil designed for extreme cold weather application such as a synthetic oil. (Contact HWH for recommendations.)

**DO NOT run the pump motor continuously. It is important that any time the pump runs for more than three minutes with a 3" motor; or six minutes with a 3.7" or 4.5" motor that the motor is allowed to cool for thirty minutes before continuing. Continuous operation of the pump motor without allowing the motor to cool can damage the motor.** Continuous operation of the pump with slow moving jacks or rooms in cold weather, without allowing the pump motor to cool will cause the pump motor to burn up and damage the pump assembly.

---

# OPERATING PROCEDURES

---

## NETWORK INFORMATION

The HWH 2000 series CAN system is a computerized modular network. It controls all functions of the leveling system and the room extensions. The network is active any time the ignition is in the "ON" or "ACC" position or when any room extension control panel key is "ON". Certain functions and indicator lights for the leveling system will work when the network is active. Certain functions and lights will work ONLY if the the ignition is in the "ON" or "ACC" position to start the function.

**NOTE:** The network will stay active for 10 minutes after the ignition key and all room extension control panel keys have been turned "OFF". If the leveling system was turned "ON", the network will stay active for 10 minutes after automatic leveling is complete or the system goes "EXCESS SLOPE". If manual leveling buttons were used, the network stays active for 10 minutes after the last manual button is released.

## GENERAL INSTRUCTIONS

Maintain adequate clearance in all directions for vehicles, room extensions, doors, steps, etc.. Vehicle may move in any direction due to raising or lowering of vehicle during leveling, settling of vehicle, equipment malfunction, etc..

The MASTER WARNING LIGHT will be on if an air bag has low pressure, if the ignition is in the "ON" position.

**CAUTION: DO NOT MOVE THE VEHICLE IF A ROOM IS EXTENDED. DO NOT MOVE THE VEHICLE AT SPEEDS IN EXCESS OF 5 MPH IF THE MASTER WARNING LIGHT IS ON.**

The "DUMP" and "RAISE" buttons will function with the leveling system and park brake off, if the ignition is in the "ON" or "ACC" position or if the network is active. See AIR DUMP AND RAISE FUNCTIONS section of this manual.

If the Park Brake is not set, the Leveling System cannot be turned ON and the room extension will not operate.

If a ROOM CONTROL SWITCH is being pushed, no other room or the Leveling System can be operated. If any Leveling System raise or lower function is being operated, no room control switch will work.

## HWH LIGHTED RESET SWITCH

The HWH lighted reset switch is located on the vehicle dash. If there is a failure at any time in the HWH CAN network, the network will shut down. The leveling system and all room extensions will not operate. If the ignition is off, no indicator lights will come on. If the ignition is in the "ON" or "ACC" position, the lighted reset switch and the MASTER WARNING Light will come on.

If the lighted reset switch is on, the switch must be pushed before any room or the leveling system can be operated.

A network problem with one room will not inhibit the use of the other rooms or leveling system after the reset switch is pushed.

A network problem with the leveling system will not inhibit the use of the room extensions after the reset switch is pushed.

If the lighted reset switch will not go out when pushed, there is a problem with the central control module of the network system. No rooms or the Leveling System will operate. The vehicle suspension will return to the travel mode if the ignition key is in the "ON" position.

**CAUTION: IF THE IGNITION IS IN THE "ON" POSITION AND THE LIGHTED RESET SWITCH IS ON, THE VEHICLE CAN RETURN TO RIDE HEIGHT WITHOUT RELEASING THE PARK BRAKE.**

---

# OPERATING PROCEDURES

---

## PREPARATION FOR TRAVEL

Check that all room extensions are fully retracted.  
DO NOT move the vehicle unless the room extensions are retracted.

Visually check that the vehicle is at the proper ride height for traveling.

The ignition must be in the "ON" position for the vehicle suspension to be in the travel mode. Also the "TRAVEL MODE" button must be pushed or the park brake released for the suspension to be in the travel mode if the Leveling System was used.

A lit "**TRAVEL MODE**" LIGHT indicates that the HWH Leveling System is in the TRAVEL MODE. It does not indicate that the suspension is at ride height or that the coach is ready to travel.

**CAUTION: IT IS THE OPERATOR'S RESPONSIBILITY TO CHECK THAT THE VEHICLE IS AT PROPER RIDE HEIGHT AND THE SLIDE-OUT IS FULLY RETRACTED BEFORE TRAVELING.**

Before traveling, the MASTER WARNING light must be off and the "TRAVEL MODE" light must be ON.

**NOTE: Low air pressure can turn the green "TRAVEL MODE" light off and turn the MASTER WARNING light on.**

Refer to "DUMP" and "RAISE" FUNCTIONS operating procedures when moving the vehicle with the suspension NOT at the proper ride height.

## AUTOMATIC AIR OPERATION

**NOTE: The ignition must be in the "ON" or "ACC" position to use the "AIR" button. Once the operation is started, the ignition can be moved to the "OFF" position and the operation will continue. If a ROOM CONTROL switch is being pushed, the Leveling System can not be operated.**

1. Place the transmission in the proper position for parking and set the park brake. The air leveling system can only be turned on if the ignition is in the "ON" or "ACC" position. Leaving the engine running during leveling is recommended. This will provide a better air supply for leveling.

**NOTE: If the TAG DUMP SWITCH is in the DUMP position, it is recommended that it is returned to the TRAVEL position before starting the leveling procedure.**

2. Press the "AIR" button once to enter the air mode. The LEVELING SYSTEM ACTIVE LIGHT will glow steady. The four red WARNING lights on the panel will come on. This indicates that the height control valves have been locked out. The vehicle should not be moved when these lights are on.

**NOTE: If the park brake is not set, the "NOT IN PARK/BRAKE" light will be on while the "AIR" button is being pushed.**

3. Press the "AIR" button a second time. The LEVELING SYSTEM ACTIVE LIGHT will start flashing and air leveling will begin. The system will attempt to level the vehicle by exhausting air from the air bags. If a level position is not achieved by lowering the vehicle, the low side and/or end of the vehicle will be raised by adding air to the air bags. When all four yellow LEVEL SENSING lights are out the leveling is complete.

**NOTE: Only one or two yellow LEVEL SENSING lights may be ON at one time.**

4. When all four yellow level lights are out, the LEVELING SYSTEM ACTIVE LIGHT will stop flashing and start pulsating dimly. The Leveling System is now in the SLEEP MODE. The vehicle's engine/ignition may now be turned OFF.

**NOTE: After the ignition and all room extension KEY SWITCHES are turned OFF, the CAN Network stays active for 10 minutes before shutting down. Leveling System touch panel lights will stay ON during this time and go out when the CAN Network shuts down. If the Leveling System is in the SLEEP MODE when the Network shuts down, the computer will stay ON. The Leveling System touch panel lights will all be OFF, but the Leveling System will still be in the SLEEP MODE.**

5. During the Sleep Mode, after 30 minutes the processor checks the Level Sensing Unit inputs. If no input for a yellow level light is seen, the processor remains dormant and will recheck the level unit inputs every 30 minutes. If the yellow light input stays on for one minute continuously, the processor will relevel the vehicle. If a yellow level light input is flickering, the processor will monitor the level sensing unit inputs continuously. If the yellow light input stays off for one minute, the processor reverts to checking the inputs every 30 minutes.

**NOTE: No lights, including yellow level lights, on the Touch Panel will be ON unless the Network is actively trying to level the vehicle.**

6. If the vehicle needs to be relevelled, the CAN Network will become active. The LEVELING SYSTEM ACTIVE LIGHT will flash. One or two yellow LEVELING LIGHTS will be ON. When the yellow LEVELING LIGHTS are all out, the LEVELING SYSTEM ACTIVE LIGHT will stop flashing and start pulsating dimly. The Leveling System will remain in the SLEEP MODE with the computer monitoring the LEVELING SENSING UNIT every 30 minutes, releveling the vehicle as needed.

---

# OPERATING PROCEDURES

---

## AUTOMATIC AIR OPERATION (Continued)

**NOTE:** The CAN Network will stay active for 10 minutes after releveling the vehicle and then shut down, turning the touch panel lights OFF. This happens every time the system relevels the vehicle.

7. The SLEEP MODE will continue until the "EMERGENCY STOP" button is pushed or the park brake is released, if the ignition is in the "ON" position.

**EXCESS SLOPE:** The system will attempt to level the vehicle for approximately 15 to 20 minutes. After the 15 to 20 minutes, if a LEVEL SENSING light is still on, the "EXCESS SLOPE" light will come on. The LEVEL LIGHT indicator light will go out. The "EXCESS SLOPE" light will be on whenever the network is active.

The "EXCESS SLOPE" light will be on whenever the network is active until the vehicle is leveled with all yellow LEVEL indicator lights off.

## TAG AXLE DUMP

The tag axle dump switch is supplied by Country Coach.

**IMPORTANT:** Refer to Country Coach for proper use of the TAG DUMP feature.

The tag dump switch will work only with the ignition switch in the "ON" position and the Leveling System panel off. The transmission must be in the R, N or 1 position.

**NOTE:** If the TAG DUMP switch is in the DUMP position and the ignition key is turned ON (with the Leveling System panel OFF) the tag axle air bags will go into the dump mode.

The TAG DUMP switch, in either the DUMP or TRAVEL position, will not interfere with any air leveling operations.



---

# OPERATING PROCEDURES

---

## MANUAL AIR OPERATION

**NOTE: The ignition must be in the "ON" or "ACC" position to use the "AIR" button. Once the operation is started, the ignition can be moved to the "OFF" position and the operation will continue.**

1. Place the transmission in the proper position for parking and set the park brake. The air leveling system can only be turned on if the ignition is in the "ON" position. Running the vehicle engine during leveling is recommended. This will provide a better air supply for leveling. The vehicle will level with the engine shut off, however more time will be required for leveling.

**NOTE: If the "NOT IN PARK/BRAKE" light is on, the leveling system cannot be turned on.**

2. Press the "AIR" button once to enter the air mode. The LEVELING SYSTEM ACTIVE LIGHT indicator light will glow steady. When the ignition is in the "ON" position, the four red WARNING lights on the panel will come on. This indicates that the height control valves have been locked out. The vehicle should not be moved when these lights are on.

3. The vehicle can now be leveled using the RAISE (up arrow) and LOWER (down arrow) buttons on the right half of the

panel in conjunction with the yellow LEVEL indicator lights. **Any side to side leveling should be done, if needed, before leveling the vehicle front to rear.** The yellow LEVEL indicator light indicates that side or end is low. When all yellow lights are out the vehicle is level. Try leveling the vehicle by lowering the high side or end (opposite of the lit yellow level lights). If a level position is not achieved use the RAISE (up arrow) button to raise the low side or end.

**NOTE: In either manual or automatic leveling when either front air manifold air bag pressure switch is on a front lower procedure is halted. When either rear air manifold air bag pressure switch is on, a rear lower procedure is halted. Air bag pressure switches will not interfere with either a right or left lower procedure.**

4. Turn the ignition to the "OFF" position.

5. Turn the system off.

**NOTE: If the "DUMP" or "RAISE" buttons are pushed while manually leveling the vehicle with air and the ignition is in the "ON" position, the system will latch into the dump or raise mode until the "EMERGENCY STOP" button is pushed or the ignition is turned off.**

## "DUMP" AND "RAISE" FUNCTIONS

The "DUMP" and "RAISE" functions are provided for operator convenience for purposes such as dumping the air suspension when parked.

Leave the engine running if the "RAISE" function is to be used. The park brake does not have to be set to use the "DUMP" or "RAISE" buttons.

**IMPORTANT: If the ignition is ON and the park brake is OFF, the "DUMP" and "RAISE" features will latch in and remain on. If the vehicle exceeds 10 MPH, the "DUMP" or "RAISE" functions will automatically turn off and the system will return to the TRAVEL MODE. If the park brake is set, the "TRAVEL MODE" button must be pushed before the vehicle can return to ride height.**

**CAUTION: REREAD CAUTIONS ON THE FIRST PAGE OF THIS MANUAL. THE VEHICLE MAY DROP OR RAISE AND/OR MOVE FORWARD OR BACKWARD WITHOUT WARNING CAUSING INJURY OR DEATH.**

DO NOT OPERATE THE VEHICLE UNLESS THE AIR SUSPENSION IS AT THE PROPER HEIGHT FOR TRAVEL.

The "RAISE" and "DUMP" buttons can be used at any time the network is active. The park brake does not have to be on.

If the ignition is in the "ON" position and the park brake is off, the "RAISE" or "DUMP" buttons will latch in. The vehicle will raise or lower completely and stay in that position.

The vehicle can not return to ride height until the "TRAVEL MODE" button or the "EMERGENCY STOP" button is pushed or the vehicle exceeds 10 M.P.H, putting the system in the TRAVEL MODE.

If the ignition is in the "OFF" position the "RAISE" and "DUMP" buttons will not latch in. The vehicle will remain in the position it was when the button was released. The vehicle can return to ride height when the ignition is turned to "ON" if the park brake is released or the "TRAVEL MODE" button is pushed.

**DO NOT operate the vehicle for extended distances unless the air suspension is at the proper height for travel. The vehicle can not return to ride height until the "EMERGENCY STOP" button is pushed or the vehicle exceeds 10 MPH, putting the system in the TRAVEL MODE.**

**CAUTION: IT IS THE OPERATOR'S RESPONSIBILITY TO CHECK THAT THE VEHICLE IS AT PROPER RIDE HEIGHT BEFORE TRAVELING.**

---

# OPERATING PROCEDURES

---

## ROOM EXTEND PROCEDURE

**IMPORTANT:** It is recommended to level and stabilize the vehicle before extending the room.

**IMPORTANT:** Extending or retracting any leveling jacks when the room is extended is not recommended.

1. The park brake must be set for the room to be operated.

**IMPORTANT:** If the "EXCESS SLOPE" light is ON, the vehicle should be re-leveled so all yellow LEVEL indicator lights on the touch panel are OFF. If any of the four yellow LEVEL indicator lights cannot be put out, the vehicle should be moved to a more level location before using the room extension.

**CAUTION:** KEEP PEOPLE AND OBSTRUCTIONS CLEAR OF ROOM WHEN OPERATING.

**NOTE:** Make sure there is adequate clearance to fully extend the room.

2. Insert the KEY into the KEY SWITCH on the room extension operator's panel and turn it to the "ON" position. The READY TO OPERATE light will come on steady.

**NOTE:** If the Leveling System is being operated, the room will not extend. If the room panel KEY SWITCH is on, the "READY TO OPERATE" light will flash while the Leveling System is being operated.

3. To extend the room, push and hold the ROOM CONTROL SWITCH in the "EXTEND" position. The red "PUMP ON" light will come on. Hold the ROOM CONTROL SWITCH to "EXTEND" until the room is fully extended. Releasing the switch will halt room operation and turn the "PUMP ON" light off.

**NOTE:** Hold the switch to "EXTEND" three or four seconds after the room is fully extended. This assures proper pressurization of the cylinders. **During normal operation of the room, do not reverse direction of the room until the room is fully extended. If necessary, the direction of the room may be reversed, but watch for binding of the room. If the direction of the room has been reversed, DO NOT re-extend the room until the room has been fully retracted.**

**IMPORTANT:** Do not hold the ROOM CONTROL SWITCH in the "EXTEND" position for more than ten seconds after the room is fully extended or stops moving. **If either side of the room stops moving, release the room control switch immediately. DO NOT force the room. DO NOT reverse direction of the room, contact HWH Customer Service for assistance 1-800-321-3494.**

4. Turn the KEY SWITCH to the "OFF" position and remove the key. The READY TO OPERATE light will go out.

**NOTE:** If the KEY SWITCH is left "ON" The Network will stay active and not power down.

## ROOM RETRACT PROCEDURE

**CAUTION:** KEEP PEOPLE AND OBSTRUCTIONS CLEAR OF ROOM WHEN OPERATING.

1. The park brake must be set for the room to be operated.

**IMPORTANT:** It is recommended that the room is level before retracting the room.

2. Insert the KEY into the KEY SWITCH on the room extension operator's panel and turn it to the "ON" position. The READY TO OPERATE light will come on steady.

**NOTE:** If the Leveling System is being operated, the room will not retract. If the room panel KEY SWITCH is ON, the READY TO OPERATE light will flash while the Leveling System is being operated.

3. To retract the room, push and hold the ROOM CONTROL SWITCH in the "RETRACT" position. The red "PUMP ON" light will come on. Hold the ROOM CONTROL SWITCH to "RETRACT" until the room is fully retracted. Releasing the switch will halt room operation and turn the "PUMP ON" light off.

**NOTE:** Hold the switch to "RETRACT" three or four seconds after the room is fully retracted. This assures proper pressurization of the cylinders. **During normal operation of the room, do not reverse direction of the room until the room is fully retracted. If necessary, the direction of the room may be reversed, but watch for binding of the room. If the direction of the room has been reversed, DO NOT retract the room until the room has been fully extended.**

**IMPORTANT:** Do not hold the ROOM CONTROL SWITCH in the "RETRACT" position for more than ten seconds after the room is fully retracted or stops moving. **If either side of the room stops moving, release the room control switch immediately. DO NOT force the room. DO NOT reverse direction of the room, contact HWH Customer Service for assistance 1-800-321-3494.**

4. Turn the KEY SWITCH to the "OFF" position and remove the key. The READY TO OPERATE light will go out.

**NOTE:** If the KEY SWITCH is left "ON" The Network will stay active and not power down.

# SENSING UNIT MAINTENANCE/SERVICE

## SENSING UNIT ADJUSTMENT

Level the vehicle by placing a bubble level in the center of the freezer floor or upon whichever surface within the vehicle that is to be level. Using the Leveling System and the bubble level, ignoring the yellow LEVEL lights on the Touch Panel, level the vehicle until the bubble is centered.

With the vehicle level according to the bubble level, if there are no yellow lights lit on the Touch Panel, the sensing unit is properly adjusted. If there are yellow LEVEL lights lit on the Touch Panel, manual adjustments to the Sensing Unit are needed. A Phillips screw driver or sockets w/driver or box end wrenches of 7/8, 3/4, 1/2, 5/16 or 1/4 sizes will be needed.

The Sensing Unit is mounted inside the Control Box. The Control Box is mounted to the power unit/valve assembly.

There are four LED's on the Sensing Unit, A,B,C and D. Refer to the drawing below. The Sensing Unit is adjusted by turning the adjustment nut to turn out LED's B and D. The adjustment screw will turn out LED's A and C. If the adjustment nut has to be turned more than 1/2 flat or the adjustment screw has to be turned more than 3/4 turn to turn the LED out, there may be a problem with the Sensing Unit or the mounting of the Control Box. If two LED's are on, it is best to make the B-D adjustments first, then hold the adjustment nut from moving while making the A-C adjustment.

**NOTE: If opposing LED's are lit, there is a problem with the Sensing Unit.**

**If LED (A) is lit: Turn the adjustment screw COUNTER CLOCKWISE until the LED is off.**

**If LED (C) is lit: Turn the adjustment screw CLOCKWISE until the LED is off.**

**If LED (B) is lit: Turn the adjustment nut COUNTER CLOCKWISE until the LED is off.**

**If LED (D) is lit: Turn the adjustment nut CLOCKWISE until the LED is off.**

**IMPORTANT: When all 4 LED's are off, move the vehicle to an unlevel position so one or two yellow lights are on. Level the vehicle according to the yellow LEVEL lights. Recheck the level. If more adjustment is needed, DO NOT try to adjust the sensing unit until the yellow level lights go out, instead just "tweak" the sensing unit, ignoring the LED's on the sensing unit.**

**Example: After the initial adjustment and releveling the vehicle, the front is still low. This means the front yellow level light is turning off too soon. Determine which sensing unit light is the front light, A-B-C or D. Move the adjustment for that light very, very, slightly in the OPPOSITE direction that is given in the above instructions for LED's A, B, C, and D. This will allow**

**the front yellow light to stay on slightly longer to bring the front up more. Again, unlevel the vehicle then relevel the vehicle using the yellow level lights on the touch panel. Recheck with a level. Repeat the "tweaking" process until the system levels the vehicle properly.**

**ADJUSTMENT NUT (5/16" OLD) - (1/2" NEW)**

**ADJUSTMENT SCREW (Phillips or 1/4") (OLD STYLE)**

**ADJUSTMENT NUT (7/8" or 3/4")**

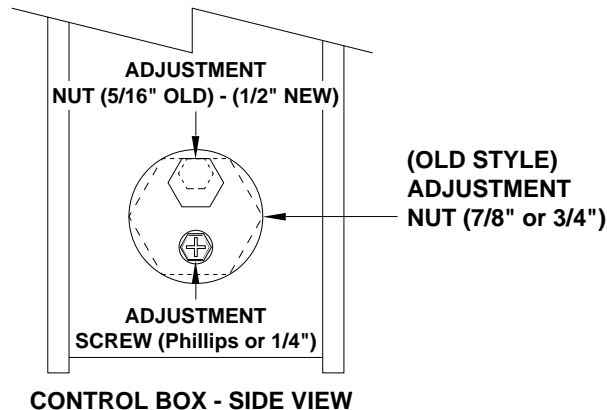
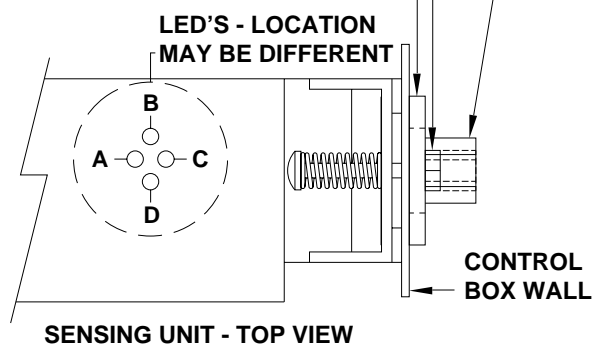

## NOT IN PARK/BRAKE CHECK

**CAUTION: WHEN MAKING THIS CHECK, BLOCK THE COACH WHEELS SECURELY SO THE COACH CANNOT ROLL FORWARD OR BACKWARD.**

Set the park/brake. Switch the ignition to the "ACC" or "ON" position. Push the "ON/OFF" switch toward "ON". Release the parking brake and confirm that the "PARK" indicator light comes on. Reset the parking brake. The "PARK" indicator light should go out. Switch the ignition to "OFF".

If any of the above checks or inspections reveal a problem or if there are other problems or questions, consult a qualified RV repair center, your vehicle or coach manufacturer, or HWH CORPORATION for service or repair.

# AIR LINE CONNECTION DIAGRAM FRONT AND DRIVE AXLE

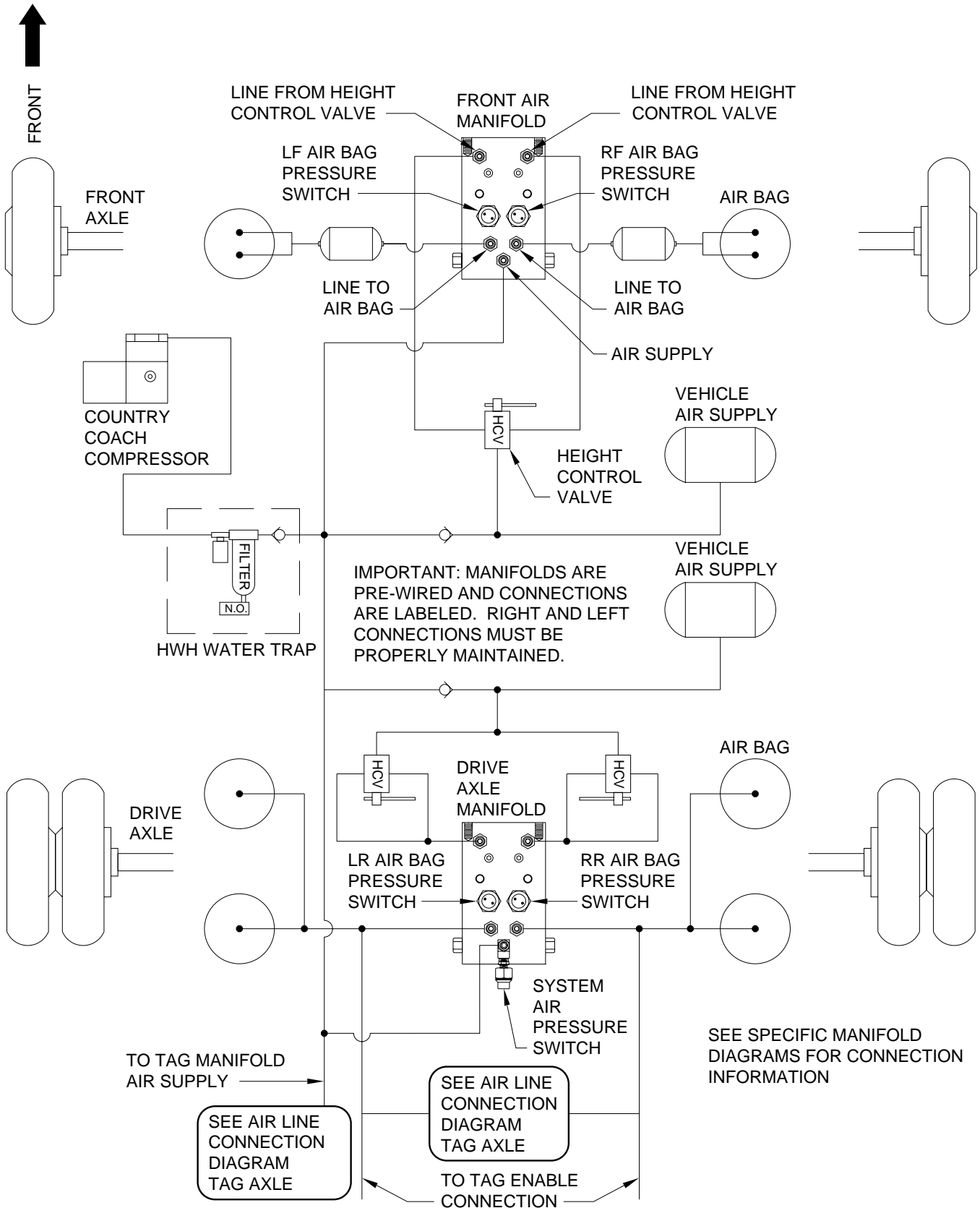

# AIR LINE CONNECTION DIAGRAM TAG AXLE

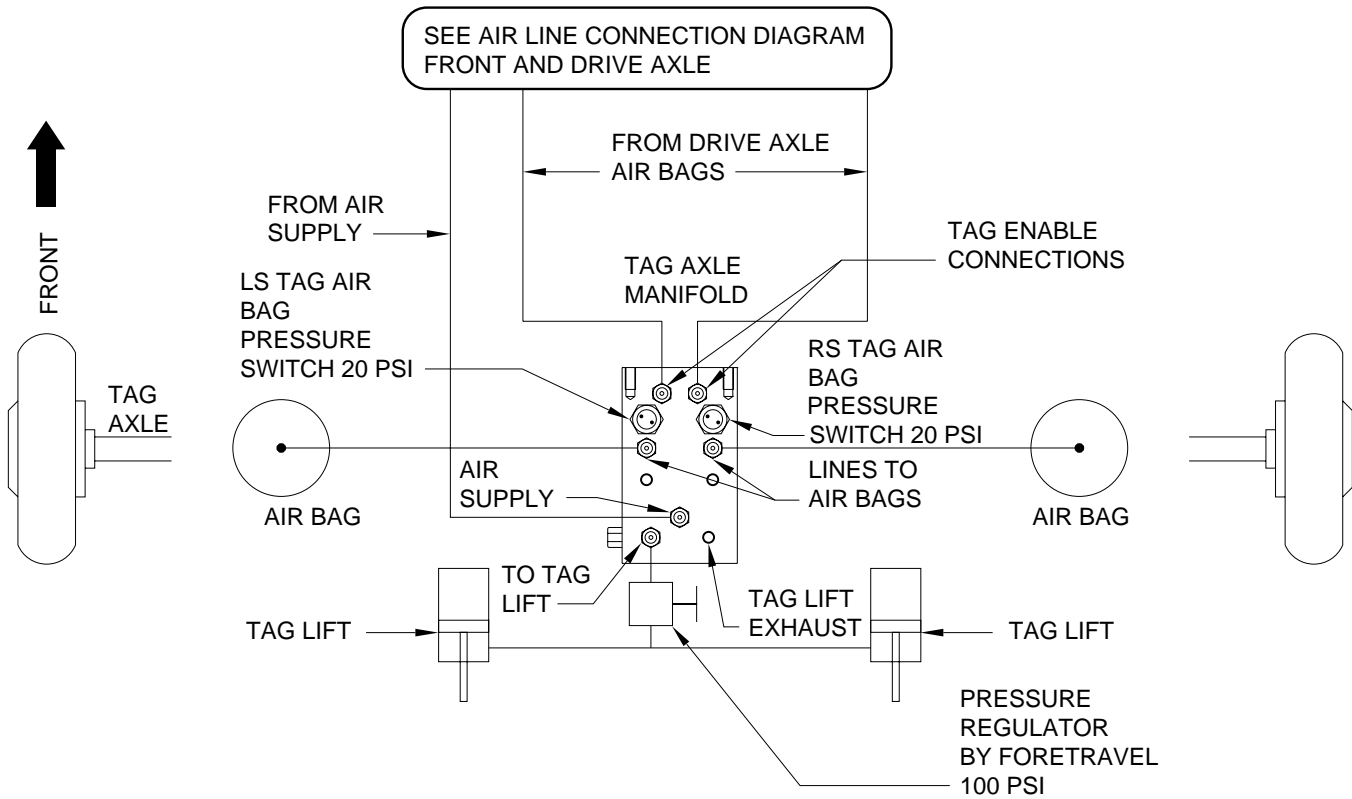

**IMPORTANT:** MANIFOLDS ARE PRE WIRED AND CONNECTIONS ARE LABELED. RIGHT AND LEFT CONNECTIONS MUST BE PROPERLY MAINTAINED

SEE SPECIFIC MANIFOLD DIAGRAMS FOR CONNECTION INFORMATION

**VALVE REPLACEMENT NOTE:** THE TAG DUMP/LOWER AIR SOLENOID VALVES ARE A DIFFERENT VALVE THAN THE OTHER VALVES ON THE MANIFOLD. ALL OTHER AIR SOLENOID VALVES ON THE FRONT, DRIVE AND TAG MANIFOLD ASSEMBLIES ARE THE SAME.

# AIR LEVEL SCHEMATIC

## 4-POINT AIR LEVELING - FRONT AND DRIVE AXLE PRESSURE SWITCHES FRONT, REAR AND TAG

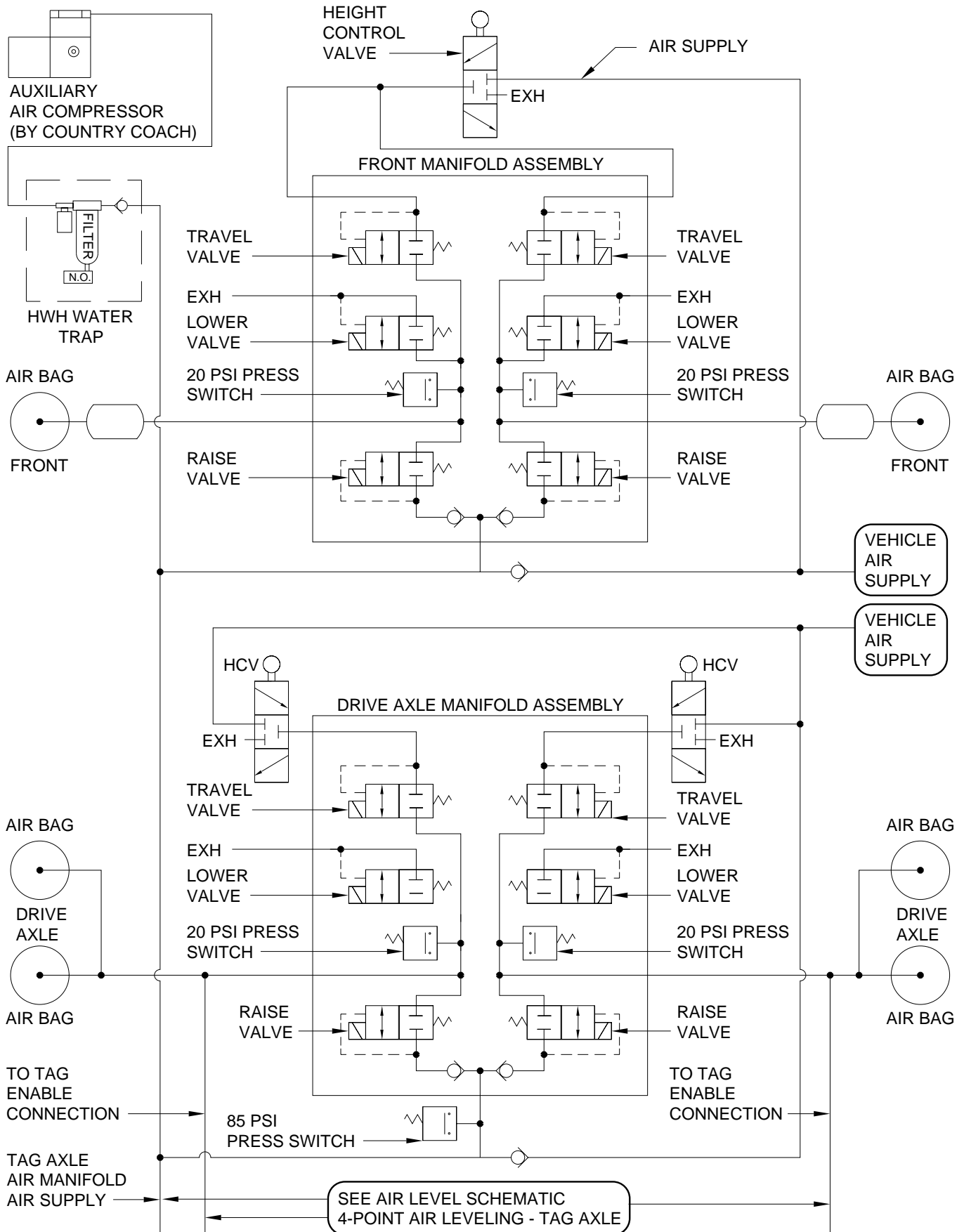

# AIR LEVEL SCHEMATIC

## 4-POINT AIR LEVELING - TAG AXLE

### PRESSURE SWITCHES FRONT, REAR AND TAG

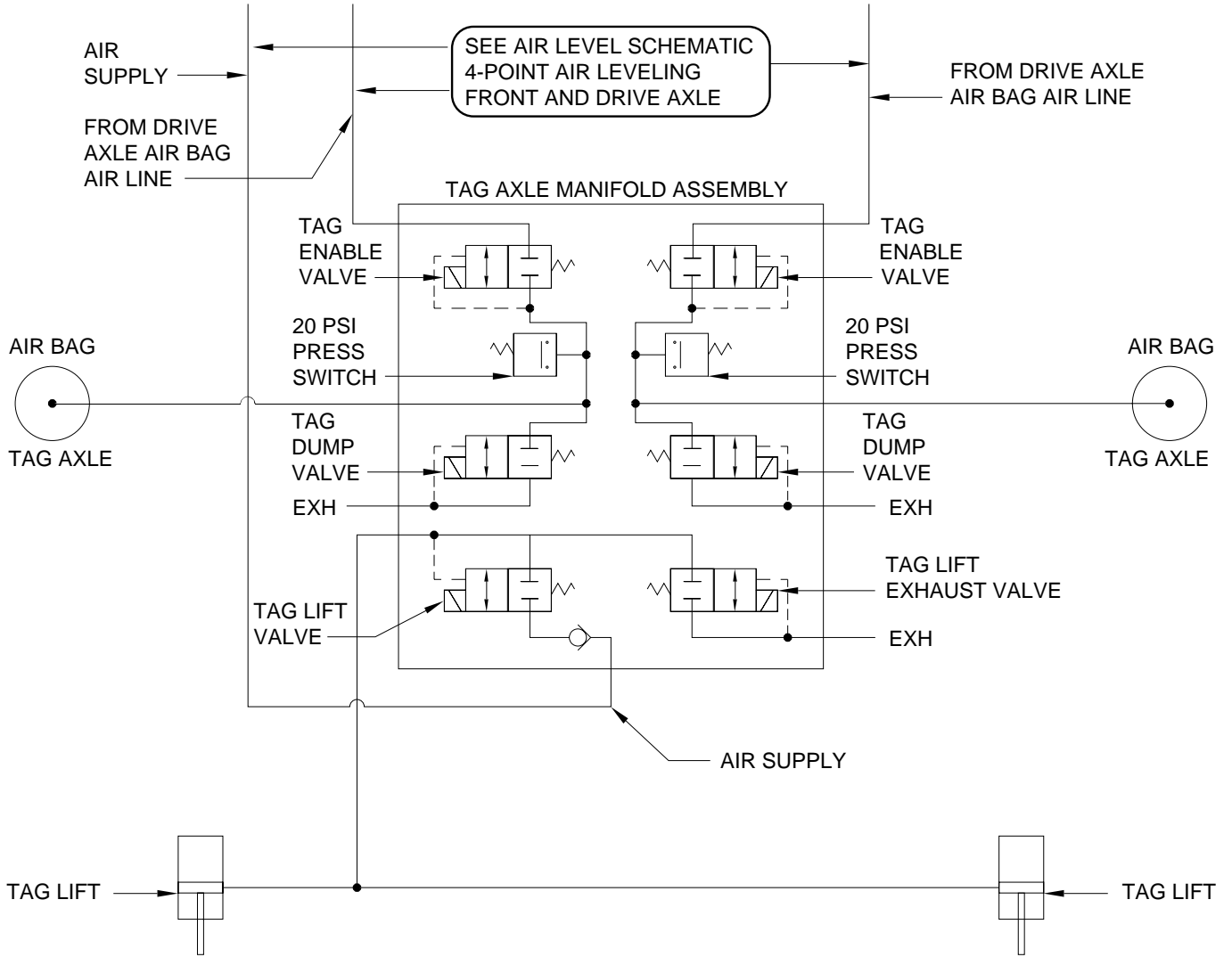

# FRONT AIR SOLENOID MANIFOLD CONNECTIONS

## 6 VALVE WITH TWO PRESSURE SWITCHES

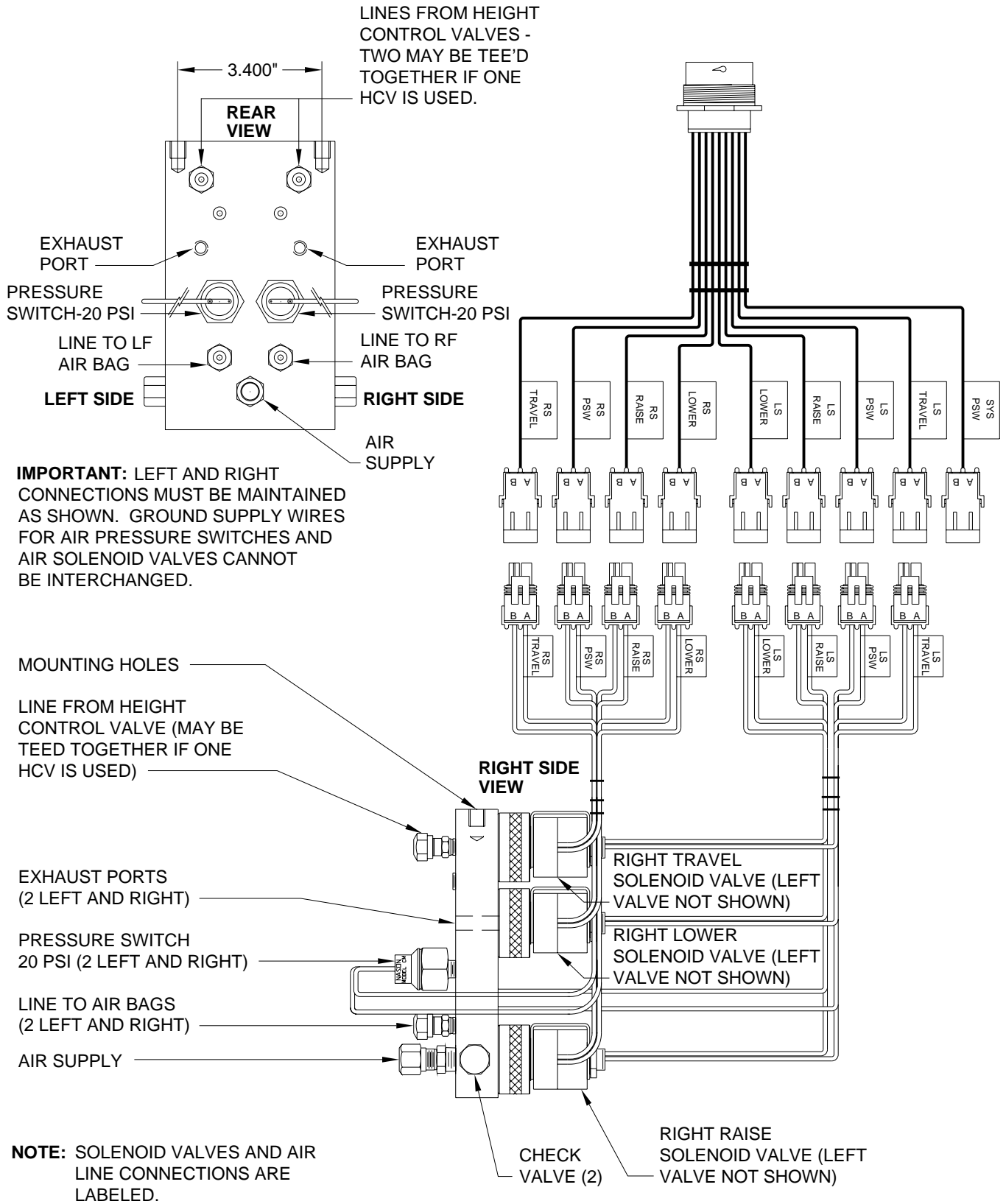



# REAR AIR SOLENOID MANIFOLD CONNECTIONS

## 6 VALVE WITH THREE PRESSURE SWITCHES

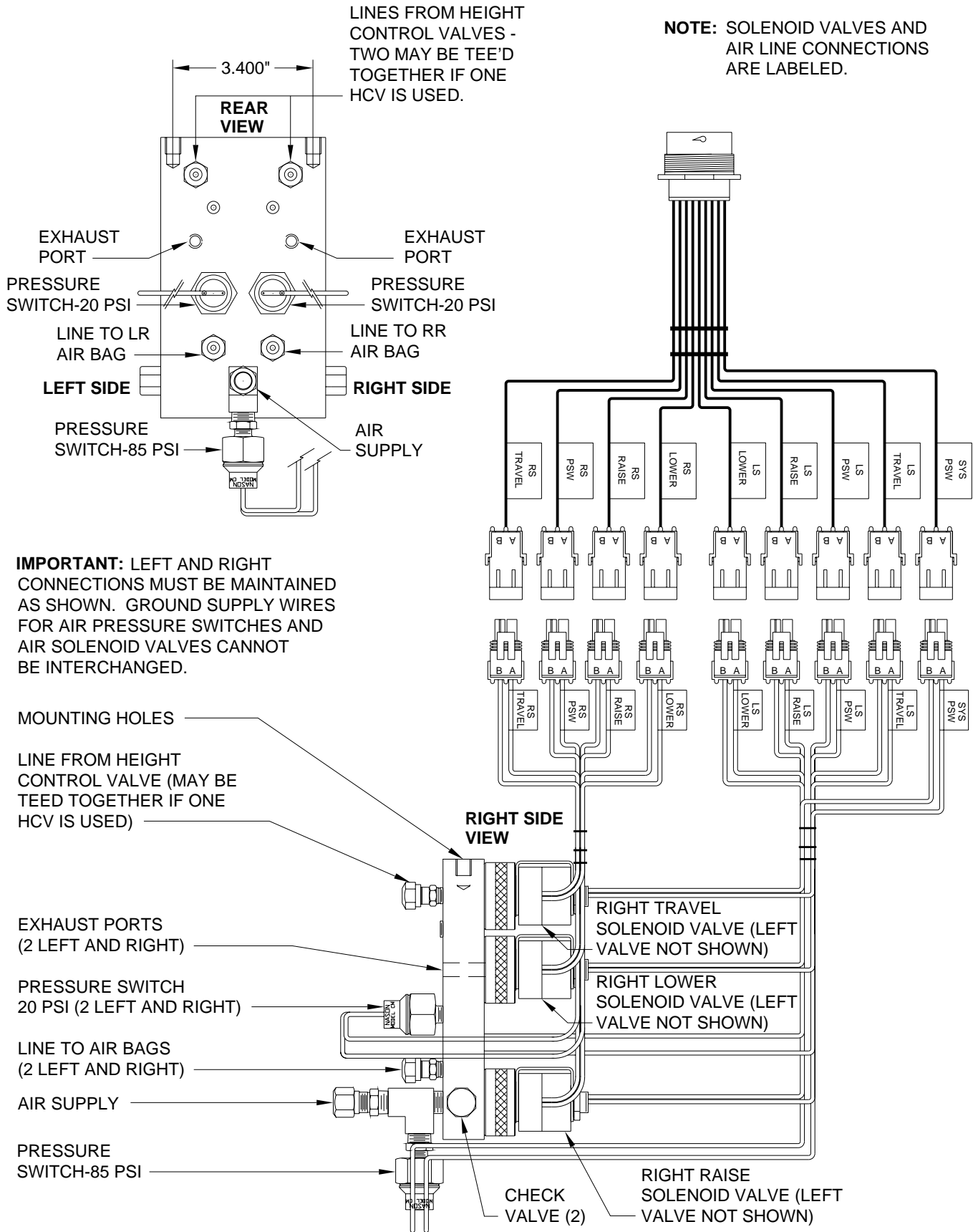

# TAG AIR SOLENOID MANIFOLD CONNECTIONS

## 6 VALVE WITH TWO PRESSURE SWITCHES

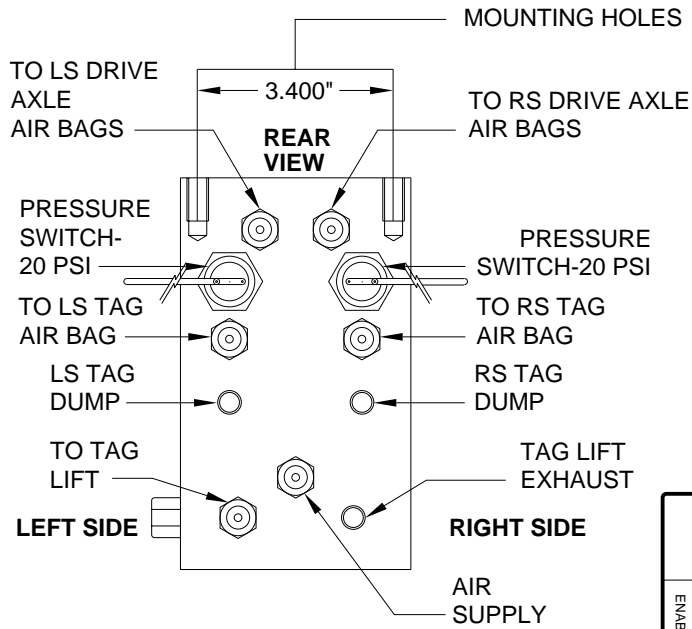

**NOTE:** SOLENOID VALVES AND AIR LINE CONNECTIONS ARE LABELED.

**NOTE:** PRESSURE SWITCHES ON TAG AXLE MANIFOLD ARE NOT USED ON ALL SYSTEMS.

**IMPORTANT:** LEFT AND RIGHT CONNECTIONS MUST BE MAINTAINED AS SHOWN. GROUND SUPPLY WIRES FOR AIR PRESSURE SWITCHES AND AIR SOLENOID VALVES CANNOT BE INTERCHANGED.

**NOTE:** THE TWO TAG DUMP SOLENOID VALVES ARE A DIFFERENT VALVE THEN THE OTHER FOUR VALVES ON THE MANIFOLD. MAKE SURE THE CORRECT VALVE IS OBTAINED FOR REPLACEMENT.

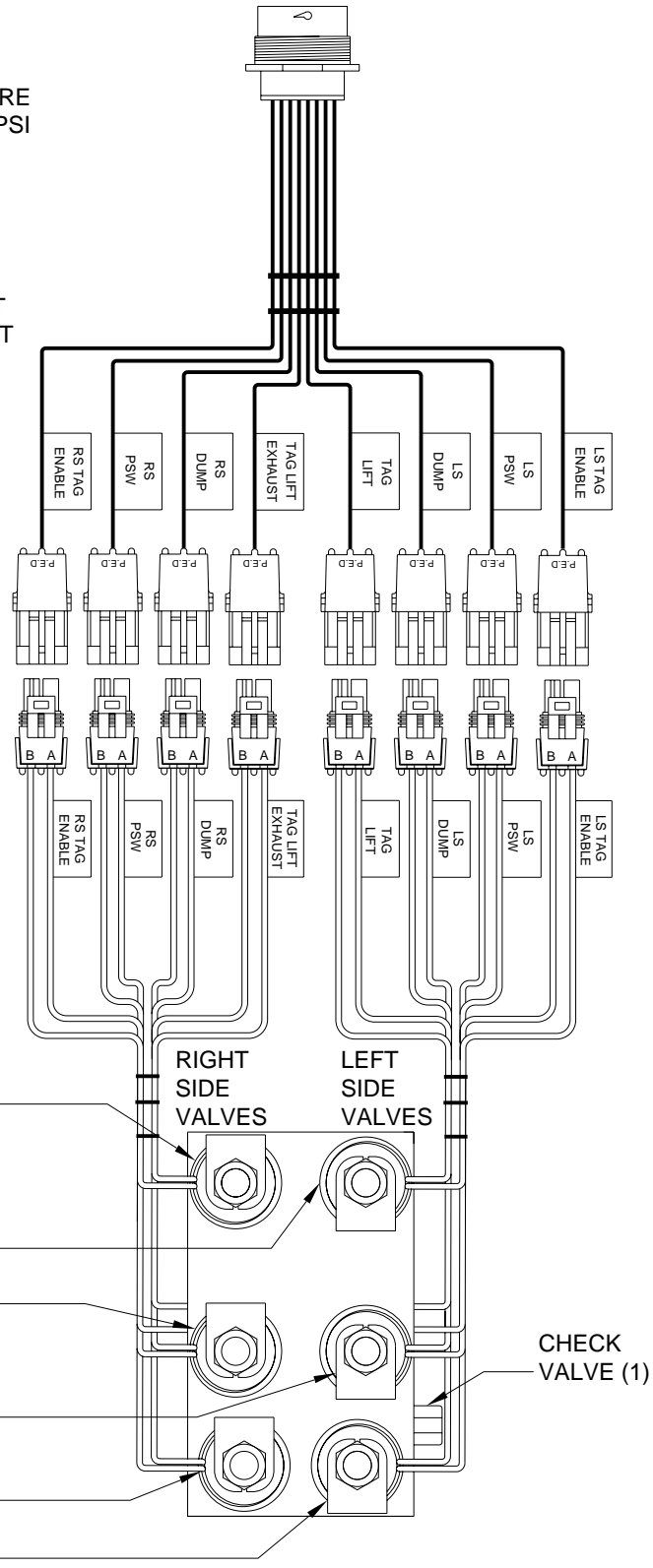

# AIR LINE CONNECTION DIAGRAM

## WATER TRAP ASSEMBLY

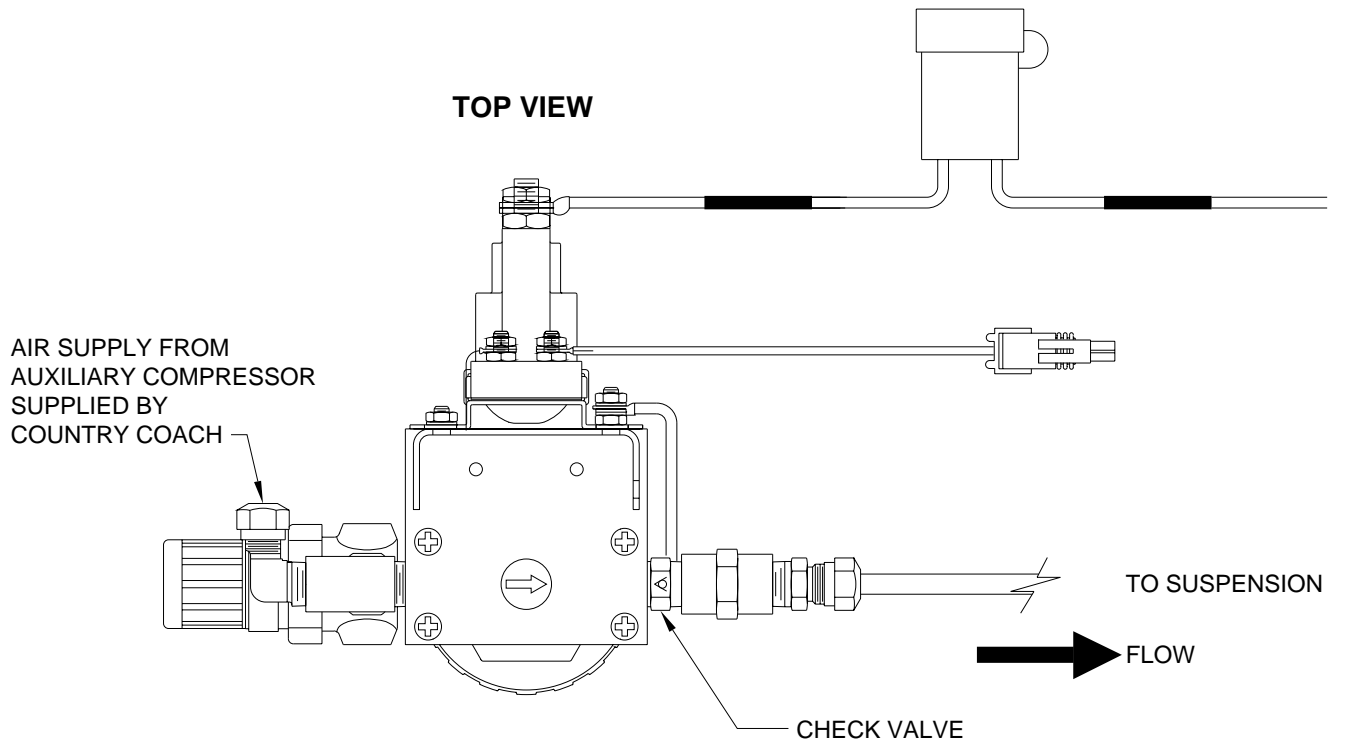

SEE ELECTRICAL CONNECTION  
DIAGRAM - WATER TRAP  
ASSEMBLY FOR CONNECTION  
INFORMATION

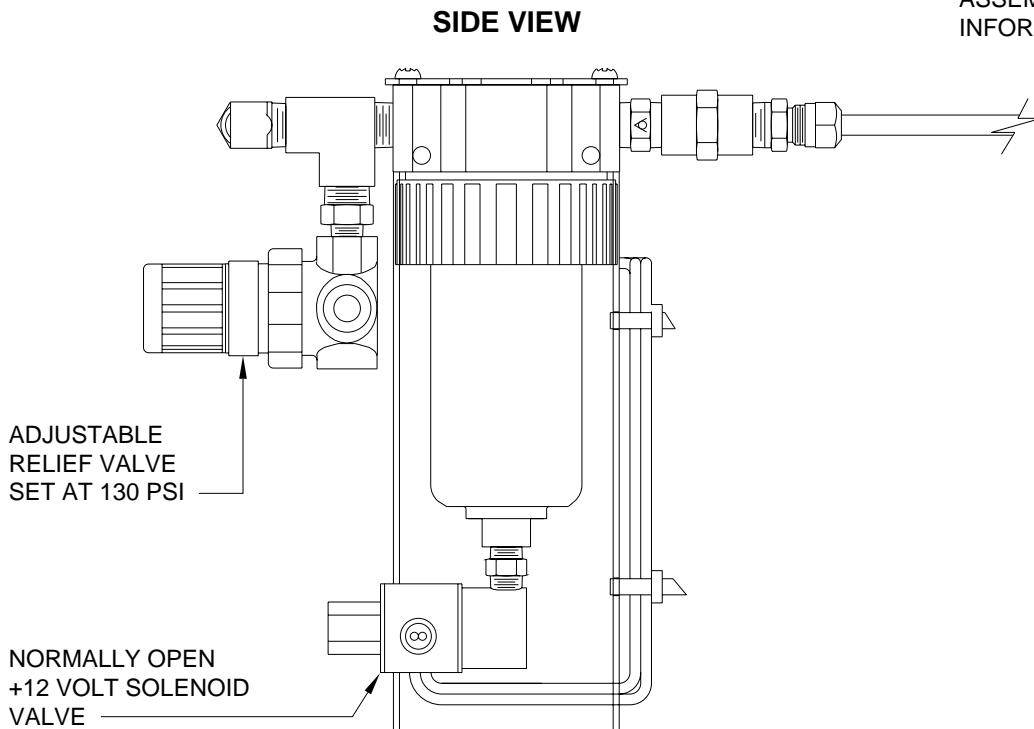

# BREATHER CAP - DIPSTICK - 1/4" NUT DRIVER

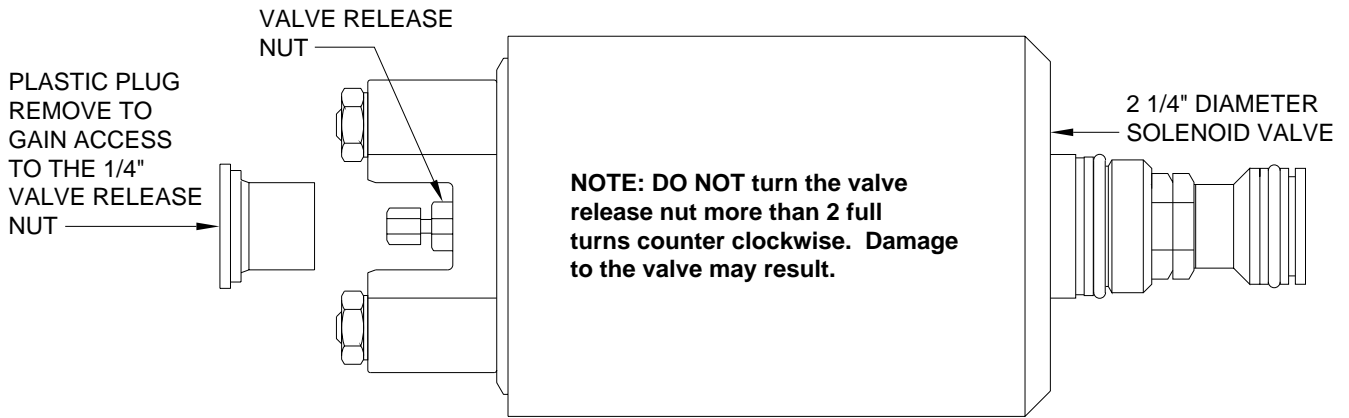
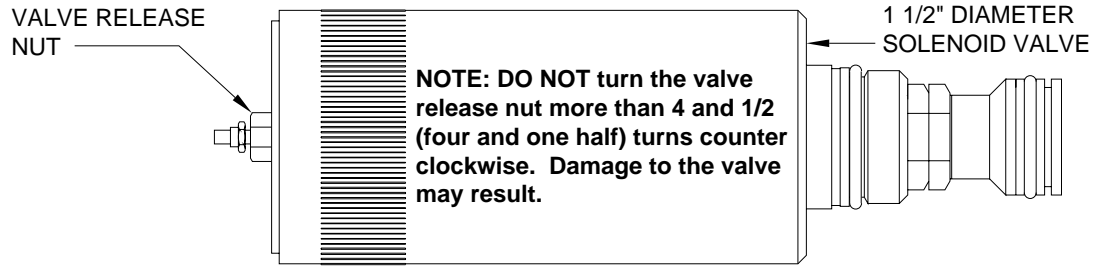

**NOTE: THE BREATHER CAP IS LOCATED ON THE TOP SIDE OF THE POWER UNIT RESERVOIR.**

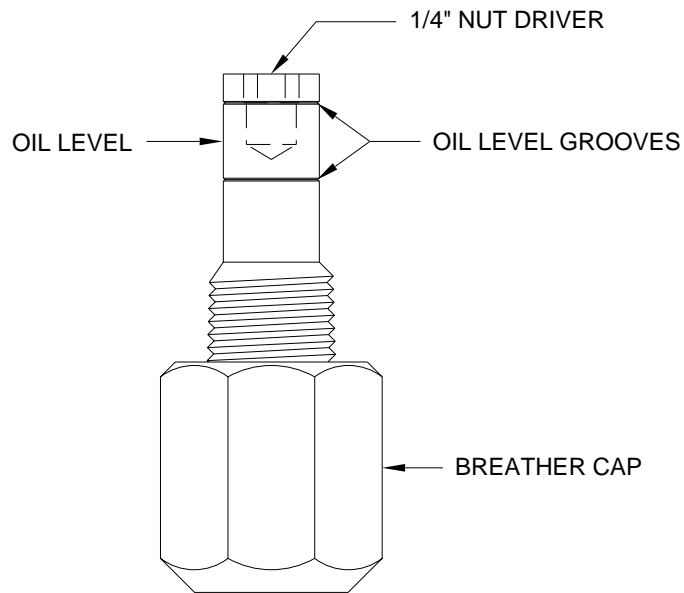

**IMPORTANT: PRIOR TO REMOVING THE BREATHER CAP, EITHER TO CHECK THE OIL LEVEL OR TO USE THE 1/4" NUT DRIVER, CLEAN ANY DEBRIS FROM THE TOP OF THE RESERVOIR. BEFORE RETURNING THE BREATHER CAP TO THE RESERVOIR, REMOVE ANY PAINT CHIPS OR OTHER DEBRIS FROM THE DIPSTICK INCLUDING DEBRIS INSIDE THE 1/4" NUT DRIVER.**