



# OPERATOR'S MANUAL

## HWH® TOUCH PANEL-CONTROLLED 625 SERIES STABILIZING SYSTEM

### **FEATURING:**

*Touch Panel Control  
Hydraulic Stabilizing  
Two Straight-Acting Jacks*

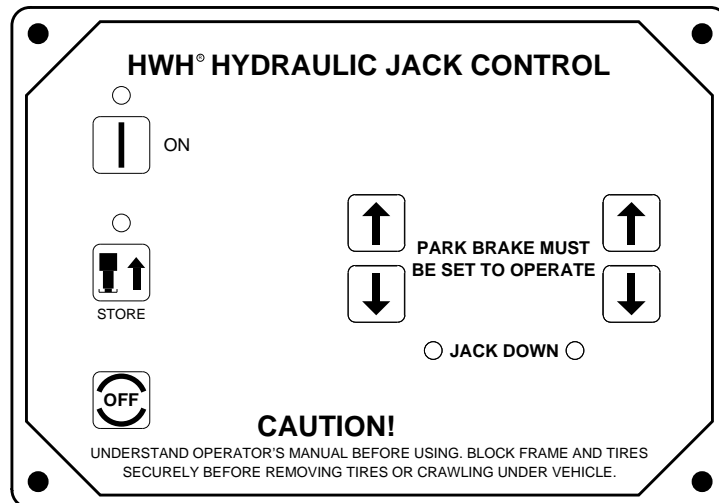

**HWH CORPORATION**  
(On I-80, Exit 267 South)  
2096 Moscow Road | Moscow, Iowa 52760  
Ph: 800/321-3494 (or) 563/724-3396 | Fax: 563/724-3408  
[www.hwh.com](http://www.hwh.com)

---

# OPERATING MANUAL

---

## WARNING !

**READ THE ENTIRE OPERATOR'S MANUAL BEFORE OPERATING.**

**BLOCK FRAME AND TIRES SECURELY BEFORE CRAWLING UNDER VEHICLE. DO NOT USE LEVELING JACKS OR AIR SUSPENSION TO SUPPORT VEHICLE WHILE UNDER VEHICLE OR CHANGING TIRES. VEHICLE MAY DROP AND/OR MOVE FORWARD OR BACKWARD WITHOUT WARNING CAUSING INJURY OR DEATH.**

**KEEP ALL PEOPLE CLEAR OF VEHICLE WHILE LEVELING SYSTEM, ROOM EXTENSIONS AND OTHER MOVABLE MECHANISMS ARE BEING OPERATED.**

**NEVER PLACE HANDS OR OTHER PARTS OF THE BODY NEAR HYDRAULIC LEAKS. OIL MAY PENETRATE SKIN CAUSING INJURY OR DEATH.**

**WEAR SAFETY GLASSES WHEN INSPECTING OR SERVICING THE SYSTEM TO PROTECT EYES FROM DIRT, METAL CHIPS, OIL LEAKS, ETC. FOLLOW ALL OTHER APPLICABLE SHOP SAFETY PRACTICES.**

**IMPORTANT: IF COACH IS EQUIPPED WITH A ROOM EXTENSION, READ ROOM EXTENSION SECTION BEFORE OPERATING LEVELING SYSTEM.**

## HOW TO OBTAIN WARRANTY SERVICE

### THIS IS NOT TO BE INTERPRETED AS A STATEMENT OF WARRANTY

HWH CORPORATION strives to maintain the highest level of customer satisfaction. Therefore, if you discover a defect or problem, please do the following:

**FIRST:** Notify the dealership where you purchased the vehicle or had the leveling system installed. Dealership management people are in the best position to resolve the problem quickly. If the dealer has difficulty solving the problem, he should immediately contact the Customer Service Department, at HWH CORPORATION.

**SECOND:** If your dealer cannot or will not solve the problem, notify the Customer Service Department:  
HWH CORPORATION 2096 Moscow Rd. Moscow IA. 52760  
(563) 724-3396 OR (800) 321-3494. Give your name and address, coach manufacturer and model year, date the coach was purchased, or the date of system installation,

description of the problem, and where you can be reached during business hours (8:00 a.m. till 5:00 p.m. c.s.t.). HWH CORPORATION personnel will contact you to determine whether or not your claim is valid. If it is, HWH CORPORATION will authorize repair or replacement of the defective part, either by appointment at the factory or by the authorization of an independent service facility, to be determined by HWH CORPORATION. All warranty repairs must be performed by an independent service facility authorized by HWH CORPORATION, or at the HWH CORPORATION factory, unless prior written approval has been obtained from proper HWH CORPORATION personnel.

# CONTROL IDENTIFICATION

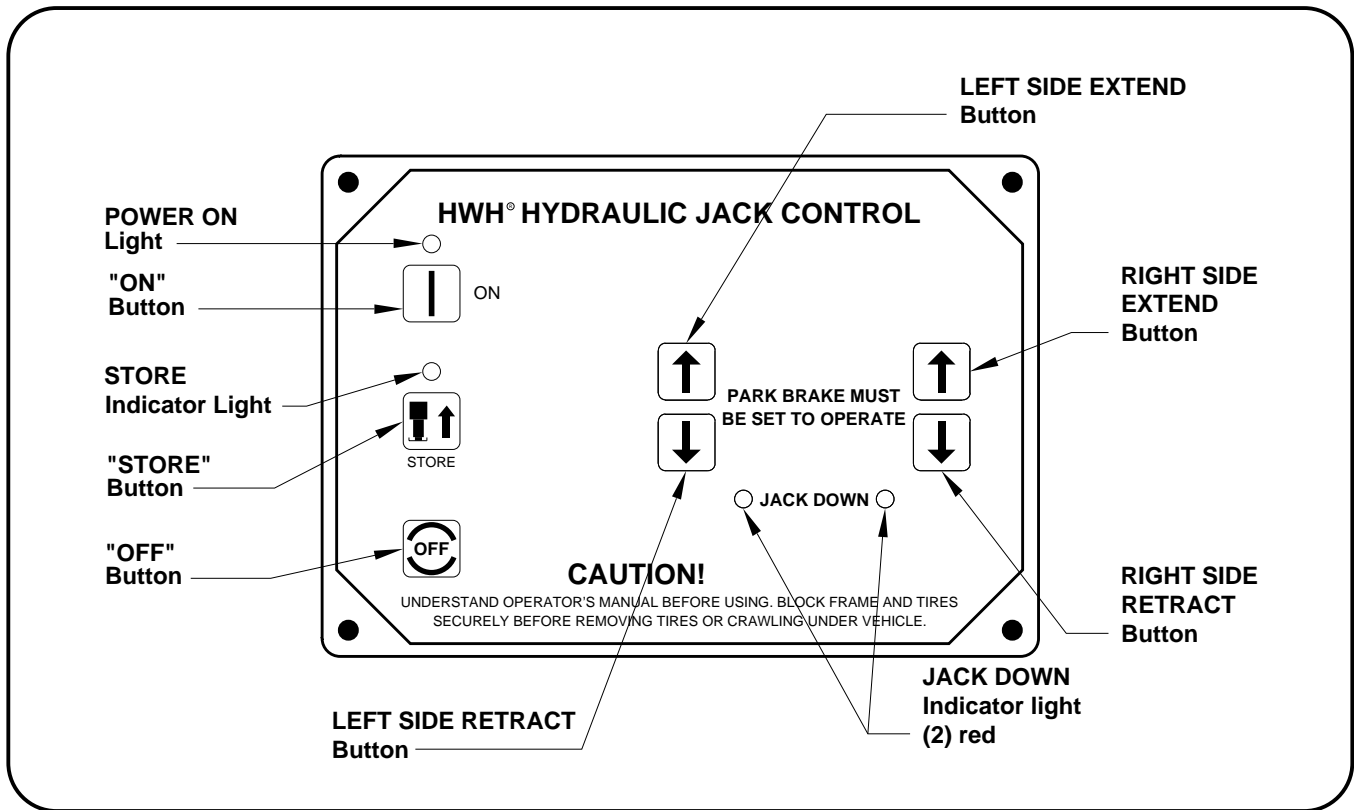

## CONTROL FUNCTIONS

### CONTROL BUTTONS

- "ON" BUTTON :** Push this button any time to start the auto stabilize function.
- "STORE" BUTTON :** This button will retract both jacks at the same time.
- "OFF" BUTTON :** This button turns off control power to the stabilizing system.
- EXTEND BUTTONS (UP ARROWS) :** These buttons will extend their respective jack to lift the vehicle.
- RETRACT BUTTONS (DOWN ARROWS) :** These buttons will retract their respective jack to lower the vehicle.

### INDICATOR LIGHTS

- POWER ON LIGHT :** This light indicates the system is active.
- STORE INDICATOR LIGHT :** This light will be on when the system is in the store mode.
- "JACK DOWN" :** These lights are functional only when the ignition is in the "ON" or "ACC" position, and the jacks are extended 1/4 to 1/2 inch.
- MASTER "JACKS DOWN" WARNING LIGHT :** This is a light mounted in the dash separate from the touch panel. If equipped, it will be on when any one or more jacks are extended and the ignition is in the "ON" position and the park brake is off.

---

# CONTROL IDENTIFICATION

## PUMP RUN TIME

---

### PUMP RUN TIME

Pump motors used with HWH leveling systems and room extension systems come in 3 different diameters; 3", 3.7" and 4.5". Contact the vehicle manufacturer or HWH for help with identifying the motor size. **It is important that any time the pump runs for more than three minutes with a 3" motor; or six minutes with a 3.7" or 4.5" motor that the motor is allowed to cool for thirty minutes before continuing. Continuous operation of the pump motor without allowing the motor to cool can damage the motor.** For cold weather information see "COLD WEATHER OPERATIONS" below.

The HWH systems with a computer processor monitor the pump run time and will turn the pump off if the run time exceeds a specified time. This time can vary with different systems. Due to available electronics or system design, the pump run time programs will also vary. Leveling systems and room extensions that are not controlled by a system processor have no pump run time protection. **DO NOT run the pump more than three or six minutes without allowing the pump motor to cool for thirty minutes.**

#### SYSTEM VARIATIONS FOR PUMP RUN TIME

Some systems with rooms run the rooms separate from the system processor. These systems do not monitor pump run time when operating the rooms. **DO NOT run the pump more than three or six minutes without allowing the pump motor to cool for thirty minutes.**

Some systems can be turned back on immediately after the processor turns the pump off. **DO NOT turn the system back on or run the pump without allowing the pump motor to cool for thirty minutes.**

When operating some leveling systems manually or operating the room extensions, the pump will turn off and back on while pushing the control button when the pump run time has been exceeded. **DO NOT continue without allowing the pump motor to cool for thirty minutes.**

With some systems, when the processor has turned the pump off because the run time has been exceeded, power to the HWH system must be turned off and back on before the system will operate. With motorized vehicles, turn the ignition off and back on. With non-motorized vehicles, turn the master power switch for the HWH system off and back on. **DO NOT continue without allowing the pump motor to cool for thirty minutes.**

Some HWH systems are equipped with a lighted reset switch. If the processor turns the pump off because the run time has been exceeded, the light in the reset switch will turn on. The system will not operate until the reset switch is pushed.

**DO NOT continue without allowing the pump motor to cool for thirty minutes.**



LIGHTED RESET SWITCH

**No matter what HWH system is on the vehicle, the pump should not be ran for more than three minutes (3" motors) or six minutes (3.7" or 4.5" motors) without allowing the pump motor to cool for thirty minutes. Continuous operation of the pump motor without allowing the motor to cool can damage the pump motor.**

Contact HWH corporation to get specific information about the system in this vehicle.

## COLD WEATHER OPERATIONS

HWH leveling and room extension systems are designed to function in cold weather down to 0 degrees Fahrenheit. Below freezing (32 degrees Fahrenheit) the jacks or rooms will operate slower than usual.

For operation in temperatures dropping below -20 degrees Fahrenheit, it is necessary that the system is equipped with oil designed for extreme cold weather application such as a synthetic oil. (Contact HWH for recommendations.)

**DO NOT run the pump motor continuously. It is important that any time the pump runs for more than three minutes with a 3" motor; or six minutes with a 3.7" or 4.5" motor that the motor is allowed to cool for thirty minutes before continuing. Continuous operation of the pump motor without allowing the motor to cool can damage the motor.** Continuous operation of the pump with slow moving jacks or rooms in cold weather, without allowing the pump motor to cool will cause the pump motor to burn up and damage the pump assembly.

---

# OPERATING PROCEDURES

---

## GENERAL INSTRUCTIONS

Maintain adequate clearance in all directions for vehicle, room extensions, awnings, doors, steps, etc. Vehicle may move in any direction due to jacks extending or retracting, settling of the jacks or the vehicle, equipment malfunction, etc..

If parking on soft ground or asphalt paving, a wood block or pad should be placed under each jack.

Press the "OFF" button or turn the ignition switch "OFF" at any time to stop the operation of the system.

Any time a hydraulic stabilizing process is interrupted, retract the jacks according to the JACK RETRACTION Section and then restart the stabilizing process.

If the hand / auto brake is not set when the "ON" button is pressed, the system will not function. The manual UP and DOWN arrows will not work.

**CAUTION: DO NOT MOVE THE VEHICLE IF ONE OR MORE JACKS ARE EXTENDED TO THE GROUND.**

## PREPARATION FOR TRAVEL

If the jacks are retracted but a red "WARNING" light is lit the system needs to be serviced.

Any room extension or generator slide should be fully retracted before traveling.

**CAUTION: DO NOT MOVE THE VEHICLE WHILE THE JACKS ARE STILL IN CONTACT WITH THE GROUND OR IN THE EXTEND POSITION. THIS VEHICLE IS EQUIPPED WITH STRAIGHT-ACTING JACKS. MOVING THE VEHICLE WITH THE JACKS EXTENDED CAN CAUSE SEVERE DAMAGE TO THE JACKS AND OR THE VEHICLE AND CREATE A DRIVING HAZARD. DO NOT RELY SOLELY UPON WARNING LIGHTS. IT IS THE OPERATOR'S RESPONSIBILITY TO CHECK THAT ALL JACKS ARE FULLY RETRACTED INTO THE STORE/TRAVEL POSITION.**

If the jacks cannot be retracted according to the JACK RETRACTION Section, retract the jacks according to the MANUAL JACK RETRACTION Section. The system should then be checked.

**NOTE: If the vehicle is parked or stored with the jacks extended for an extended period of time and the jacks fail to retract completely, extend the jacks back down to the ground then retract the jacks again.**

---

# OPERATING PROCEDURES

## 625 SERIES LEVELING SYSTEM

---

### AUTOMATIC HYDRAULIC STABILIZING

1. Place transmission in the recommended position for parking the vehicle and set parking brake. Turn the coach engine off. Turn the ignition to the "ACCESSORY" position.
2. At this time, the operator may want to check the jacks and place a pad under each jack if the ground will not support the vehicle.
3. Press the "ON" button one time.  
The ON light will start to flash.

**IMPORTANT:** During the Automatic Stabilizing procedures, pushing the "ON", "STORE" or the "OFF" button on the HWH touch panel will stop the automatic stabilizing function.

The system will automatically extend the jacks to stabilize the vehicle. After the system has finished stabilizing, it will automatically shut off.

5. Turn the ignition switch to the "OFF" position.

### JACK RETRACTION

**CAUTION:** THE OPERATOR MUST BE SURE THAT THERE ARE NO OBJECTS UNDER THE VEHICLE AND THAT ALL PEOPLE ARE CLEAR OF THE VEHICLE.

**NOTE:** When the jacks are stored with the ignition in the ON position, the warning buzzer will sound until the jacks have retracted to the STORE position. If desired, the jacks can be stored with the ignition key in the accessory position. This will eliminate the warning buzzer while the jacks are retracting.

1. Press the "STORE" button. The store indicator light will flash. As each jack retracts, its red WARNING light will go out. The system will automatically shut down six minutes after the individual red "WARNING" lights go out. If any one red "WARNING" light does not go out, the system will continue to store for thirty minutes, then shut down regardless of the "WARNING" light condition.

**NOTE:** When traveling thermal expansion may cause a jack to extend slightly. When the "STORE" button has been used to retract the jacks, the system will automatically retract any jack that extends due to thermal expansion.

**IMPORTANT:** If power to the system is interrupted after starting a store procedure, the store procedure should be reinitiated and the jacks should be completely retracted with all red WARNING lights out prior to traveling.

**IMPORTANT:** During the Automatic Store procedures, pushing the "ON", "STORE" or the "OFF" button on the HWH touch panel will stop the automatic store function.

**CAUTION:** DO NOT MOVE THE VEHICLE WHILE THE LEVELING JACKS ARE STILL IN CONTACT WITH THE GROUND OR IN THE EXTEND POSITION. THIS VEHICLE IS EQUIPPED WITH STRAIGHT-ACTING JACKS. MOVING THE VEHICLE WITH THE LEVELING JACKS EXTENDED CAN CAUSE SEVERE DAMAGE TO THE JACKS AND OR THE THE VEHICLE AND CREATE A DRIVING HAZARD. DO NOT RELY SOLELY UPON WARNING LIGHTS. IT IS THE OPERATOR'S RESPONSIBILITY TO CHECK THAT ALL JACKS ARE FULLY RETRACTED INTO THE STORE/TRAVEL POSITION.

2. The vehicle can be moved as soon as the red warning lights are out and the jacks are in the STORE/TRAVEL position.

**IMPORTANT:** If a red warning light and buzzer come on while traveling, the jacks should be checked as soon as a safe parking location is found.

3. If jacks cannot be retracted by the above procedure see MANUAL JACK RETRACTION Section.

---

# OPERATING PROCEDURES

---

## MANUAL HYDRAULIC OPERATION

1. Place transmission in the recommended position for parking the vehicle, and set the parking brake. Turn the ignition to the "ACCESSORY" position.

2. Place pads under the jack feet if the ground will not support the vehicle on the jacks.

3. The vehicle may be stabilized using the manual EXTEND (UP ARROW) buttons on the right half of the panel. Push and hold an UP ARROW to extend a jack to the ground. Jacks used to stabilize the vehicle should lift the vehicle slightly after touching the ground.

**IMPORTANT: Do not continue to push an EXTEND button for more than ten (10) seconds after a jack is fully extended.**

4. When stabilizing turn the ignition switch to the "OFF" position.

# OPERATING PROCEDURES

## MANUAL JACK RETRACTION

### MANUAL JACK RETRACTION

**WARNING:** KEEP AWAY FROM THE WHEELS, DO NOT CRAWL UNDER THE VEHICLE, KEEP A SAFE DISTANCE IN FRONT AND REAR OF THE VEHICLE. THE VEHICLE MAY DROP AND/OR MOVE FORWARD OR BACKWARD WITHOUT WARNING AS THE VALVE RELEASE IS OPERATED.

**IMPORTANT:** HWH recommends that all HWH room extensions are fully retracted prior to performing manual jack retraction procedures.

Use the manual valve release for retracting the jacks only if the STORE feature on the HWH control panel will not retract the jacks.

1. Locate your power unit-manifold assembly.  
(The diagram below represents a typical Power Unit-Manifold Assembly it may not be an exact match to yours).

**NOTE:** Multiple manifolds may be present on the power unit. The upper most manifold should control jack functions. (Valve styles and arrangements will vary)

2. Allow clearance for the vehicle to lower.

3. Using the diagram below identify the style of your two center valves.

**NOTE:** As of APRIL 2002 a 1/4" Nut Driver has been incorporated into the Breather Cap. Before using read and understand the last page of this manual.

**Large style with T-Handle valve release:** The T-Handle will turn several turns easily. As the valve starts to open, the T-Handle will turn harder. Make sure the valves have been opened far enough to allow the jacks to retract.

**Small style with Valve Release Nut:** DO NOT turn the 1/4" valve release nut more than **4 and 1/2 turns**. Turning the nut more could damage the valve.

**Large style with Valve Release Nut:** The 1/4" Valve release nut is located under a plastic plug that must be removed to gain access. Open valve 1-1/2 to 2 full turns. DO NOT turn the 1/4" valve release nut more than **2 full turns**. Turning the nut more could damage the valve. Replace the protective plastic plug.

4. Retract the front jacks by opening the two center valves. Slowly turn the manual valve releases counter clockwise until the jacks start to retract.

5. Repeat the process by identifying then opening the two outer valves, if applicable.

6. Check that all jacks are now retracted. If yes, continue. If no, notify the dealership where you purchased the vehicle or had the leveling system installed or contact HWH Corporation customer service.

7. Close the valves by turning each valve release clockwise.

**IMPORTANT:** Once the manual valve release is snug, DO NOT tighten the manual valve release past this point as internal damage may occur to the solenoid.

8. The system should now be repaired before using again.

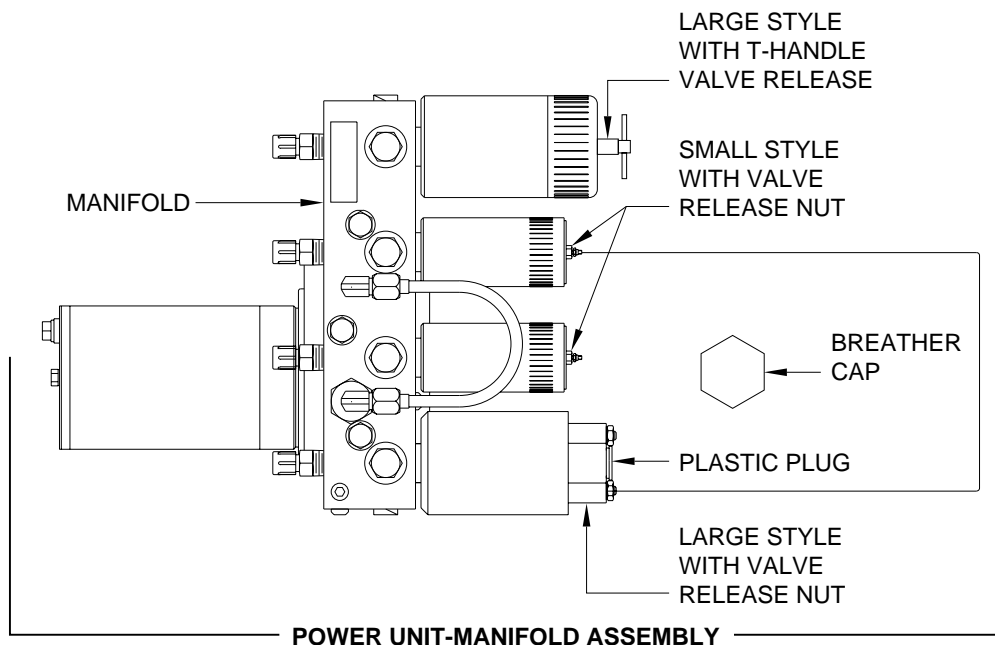



---

# MAINTENANCE

---

## OIL LEVEL

All maintenance should be done as part of the normal servicing of the coach.

The oil level should be checked when the vehicle is first purchased and then once every two years. More often if there is an oil leak in the system.

All jacks and any HWH room extension cylinders should be completely retracted before checking the oil level. The oil reservoir is part of the pump/manifold assembly. The oil level is checked and filled through the breather cap. Clear any dirt away from the breather/filler cap before removing. The oil level should be within one inch of the top of the reservoir. Most breather caps have a dipstick.

**NOTE: Overfilling the tank can cause leakage of oil through the breather cap.**

**FLUID:** HWH Specialty Hydraulic Oil is recommended. In an emergency Dexron automatic transmission fluid can be used. **NOTE:** Dexron automatic transmission fluid contains red dye and can cause staining should a leak occur. **DO NOT USE** brake fluid or hydraulic jack fluid. Use of these can damage seals.

## ELECTRICAL SYSTEM

The batteries should be in good condition and fully charged. Weak batteries can cause erratic operation. Battery cable terminals and battery posts and connections should be kept clean.

All electrical connections, especially ground connections, should be clean, tight, free from corrosion and protected from weathering.

## JACKS

There are very few user serviceable parts on the jacks. The jacks require very little maintenance. If the jacks are extremely dirty with caked on mud they should be washed.

The jack rods should NOT be wiped and do not need to be oiled or sprayed with anything.

## ROOM EXTENSIONS

The HWH room mechanisms need no maintenance. **DO NOT** grease or lubricate any parts of the HWH mechanism.

Any visible mechanism can be kept clean by washing with water. Refer to the vehicle manufacturer for correct maintenance of the room seals.

## VISUAL INSPECTION

Periodically inspect the system for oil leaks and damaged or missing parts, such as pivot bolts or springs. Check the hydraulic lines and wiring for damage and wear.

Check that the jacks do not interfere with any parts of the vehicle when they are in the "STORE" position.

## OPERATIONAL CHECK

Review the OPERATOR MANUAL. Run the system according to the SYSTEM OPERATION Section. Note any abnormal operation.

Review the "JACK RETRACTION" Section. Make sure the jacks will fully retract to the "STORE" position. Jacks should not interfere with any of the coach when in the "STORE" position.

Check that all lights work according to the "INDICATOR LIGHT" Section. Correct function of the red "WARNING" light is important.

---

## MAINTENANCE

---

### NOT IN PARK/BRAKE CHECK

**CAUTION: WHEN MAKING THIS CHECK, BLOCK THE COACH WHEELS SECURELY SO THE COACH CANNOT ROLL FORWARD OR BACKWARD.**

Set the park/brake. Switch the ignition to the "ACC" or "ON" position. Push the "ON" switch. Release the parking brake. The ON light should go out and the jacks should stop extending. If the panel does not shut off, the system needs to be serviced. Retract the jacks and switch the ignition to "OFF".

If any of the above checks or inspections reveal a problem or if there are other problems or questions, consult a qualified RV repair center, your vehicle or coach manufacturer, or HWH CORPORATION for service or repair.

### WINTER WEATHER DRIVING

Anti-icing / deicing agents when splashed on your vehicle, continue to absorb moisture from the air even after they have dried. This can facilitate corrosion of metallic components, such as HWH jacks.

To help reduce the corrosion of jacks after exposure to anti-icing / deicing agents, thoroughly wash jacks with warm soapy water.

# INFORMATION/INSTRUCTION SHEET

## HYDRAULIC SOLENOID VALVE

### IDENTIFICATION - MANUAL OPERATIONS - REPLACEMENT

REPLACEMENT VALVES WILL HAVE A VALVE RELEASE CAM

#### BREATHER CAP W/NUT DRIVER

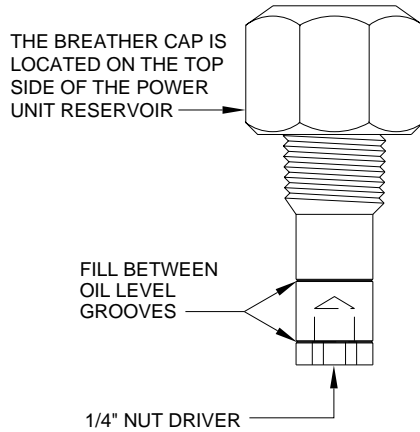

**IMPORTANT:** PRIOR TO REMOVING THE BREATHER CAP, EITHER TO CHECK THE OIL LEVEL OR TO USE 1/4" NUT DRIVER, CLEAN ANY DEBRIS FROM THE TOP OF THE RESERVOIR. BEFORE RETURNING THE BREATHER CAP TO THE RESERVOIR, REMOVE ANY PAINT CHIPS OR OTHER DEBRIS FROM THE DIPSTICK INCLUDING DEBRIS INSIDE THE 1/4" NUT DRIVER.

#### SOLENOID VALVES WITH CAM RELEASE

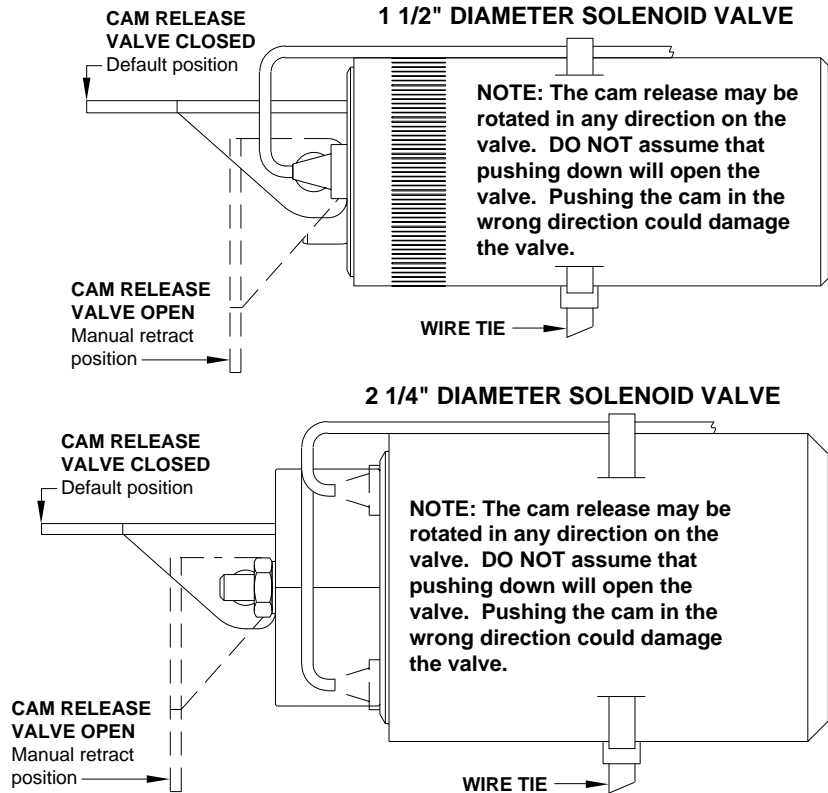

#### SOLENOID VALVES WITH 1/4" NUT RELEASE

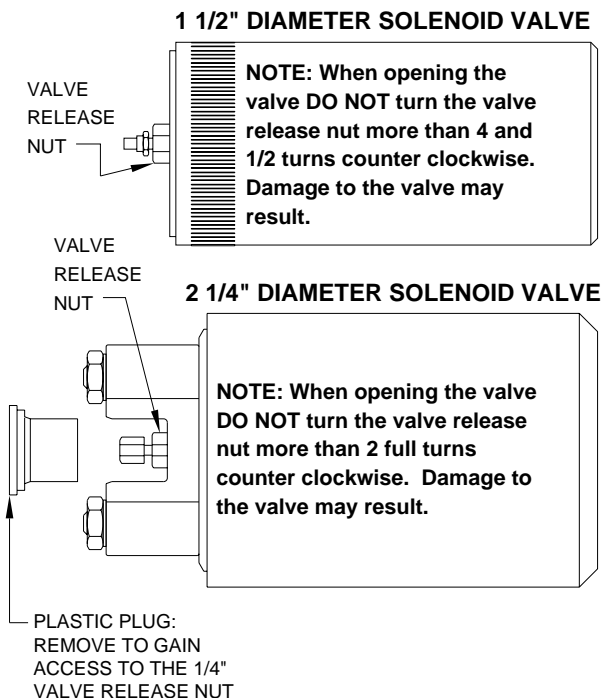

#### SOLENOID VALVES WITH T-HANDLE RELEASE

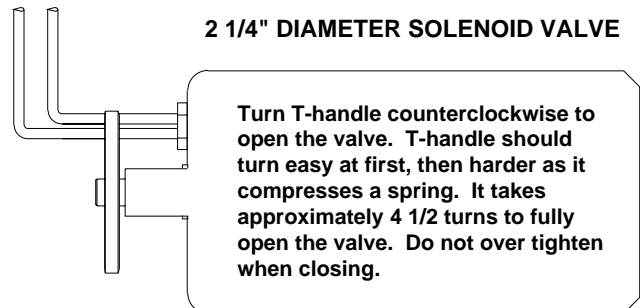

**NOTE: OLD STYLE HEX SHAPED SOLENOID VALVES HAVE NO MANUAL VALVE RELEASE.**