



OPERATOR'S MANUAL

HWH® COMPUTER-CONTROLLED 700 SERIES LEVELING SYSTEM

FEATURING:

Single Step Touch Panel Control

Air Leveling

1 or 2 Room Extensions

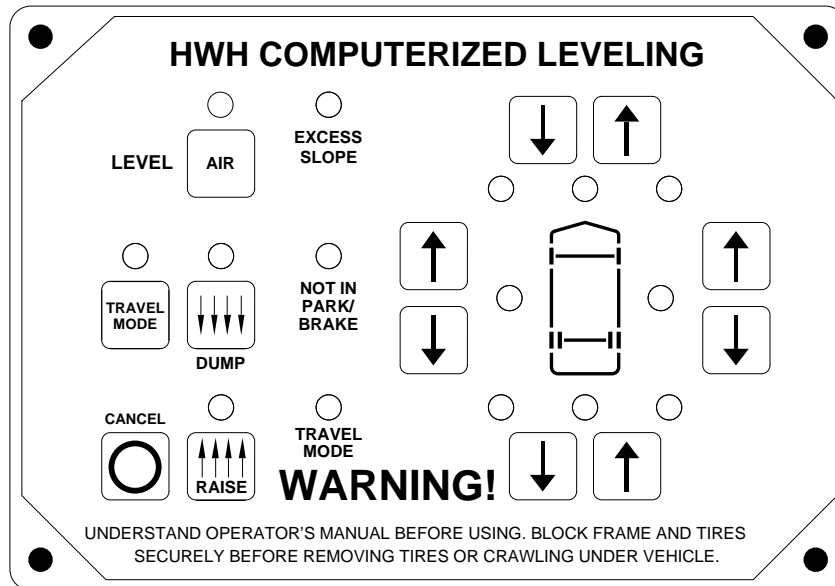

HWH CORPORATION

(On I-80, Exit 267 South)

2096 Moscow Road | Moscow, Iowa 52760

Ph: 800/321-3494 (or) 563/724-3396 | Fax: 563/724-3408

www.hwh.com

OPERATOR'S MANUAL

WARNING !

READ THE ENTIRE OPERATOR'S MANUAL BEFORE OPERATING.

BLOCK FRAME AND TIRES SECURELY BEFORE CRAWLING UNDER VEHICLE. DO NOT USE LEVELING JACKS OR AIR SUSPENSION TO SUPPORT VEHICLE WHILE UNDER VEHICLE OR CHANGING TIRES. VEHICLE MAY DROP AND/OR MOVE FORWARD OR BACKWARD WITHOUT WARNING CAUSING INJURY OR DEATH.

KEEP ALL PEOPLE CLEAR OF VEHICLE WHILE LEVELING SYSTEM AND ROOM EXTENSION ARE BEING OPERATED.

NEVER PLACE HANDS OR OTHER PARTS OF THE BODY NEAR HYDRAULIC LEAKS. OIL MAY PENETRATE SKIN CAUSING INJURY OR DEATH.

DO NOT TRAVEL IF THE VEHICLE IS NOT AT THE PROPER RIDE HEIGHT. CONTACT MANUFACTURER TECHNICAL SERVICE FOR TRAVELING WHEN NOT AT THE PROPER RIDE HEIGHT.

DO NOT USE THE DUMP OR RAISE BUTTONS IF THE VEHICLE IS MOVING IN EXCESS OF 5 MPH.

WEAR SAFETY GLASSES WHEN INSPECTING OR SERVICING THE SYSTEM TO PROTECT EYES FROM DIRT, METAL CHIPS, OIL LEAKS, ETC. FOLLOW ALL OTHER APPLICABLE SHOP SAFETY PRACTICES.

IMPORTANT: IF COACH IS EQUIPPED WITH A ROOM EXTENSION, READ ROOM EXTENSION SECTION BEFORE OPERATING LEVELING SYSTEM.

HOW TO OBTAIN WARRANTY SERVICE

THIS IS NOT TO BE INTERPRETED AS A STATEMENT OF WARRANTY

HWH CORPORATION strives to maintain the highest level of customer satisfaction. Therefore, if you discover a defect or problem, please do the following:

FIRST: Notify the dealership where you purchased the vehicle or had the leveling system installed. Dealership management people are in the best position to resolve the problem quickly. If the dealer has difficulty solving the problem, he should immediately contact the Customer Service Department, at HWH CORPORATION.

SECOND: If your dealer cannot or will not solve the problem, notify the Customer Service Department:
HWH CORPORATION 2096 Moscow Rd. Moscow IA. 52760
(563) 724-3396 OR (800) 321-3494. Give your name and address, coach manufacturer and model year, date the coach was purchased, or the date of system installation,

description of the problem, and where you can be reached during business hours (8:00 a.m. till 5:00 p.m. c.s.t.). HWH CORPORATION personnel will contact you to determine whether or not your claim is valid. If it is, HWH CORPORATION will authorize repair or replacement of the defective part, either by appointment at the factory or by the authorization of an independent service facility, to be determined by HWH CORPORATION. All warranty repairs must be performed by an independent service facility authorized by HWH CORPORATION, or at the HWH CORPORATION factory, unless prior written approval has been obtained from proper HWH CORPORATION personnel.

CONTROL IDENTIFICATION

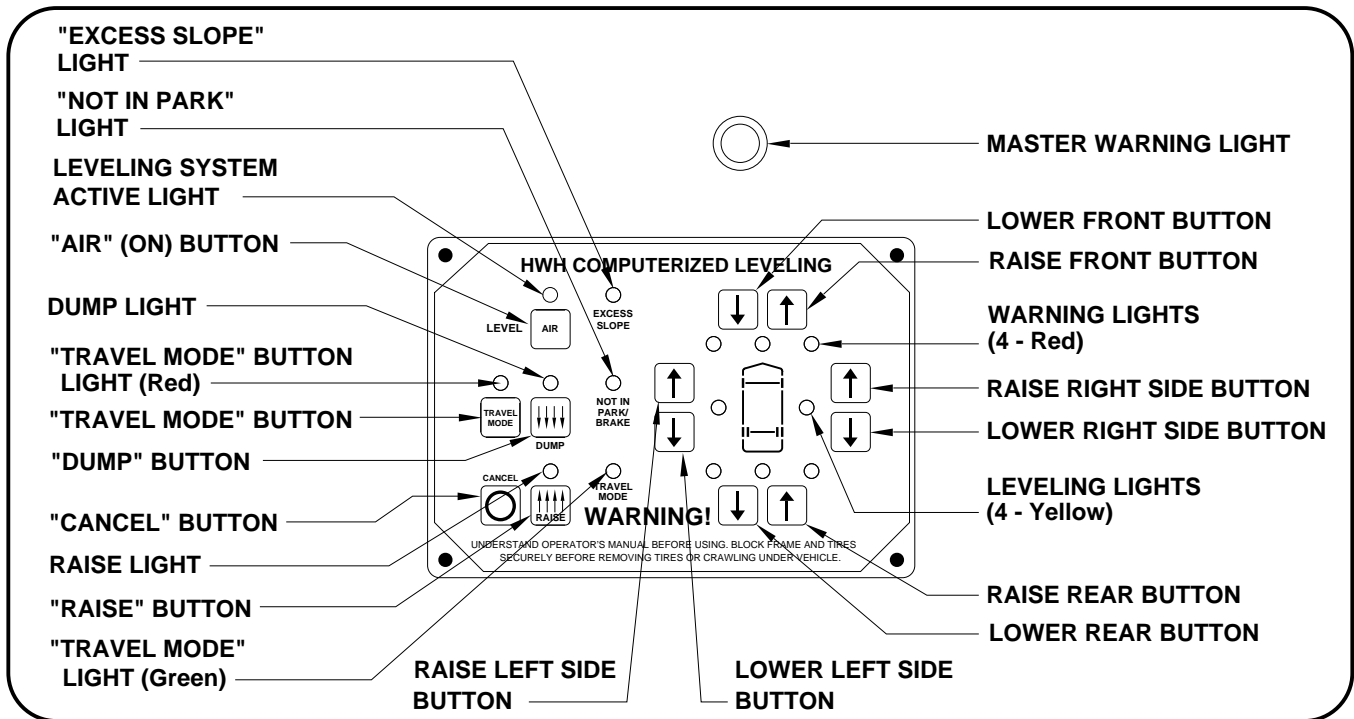

CONTROL FUNCTIONS

CONTROL BUTTONS

"AIR" BUTTON: This is the automatic operation button. It works if the ignition is in the "ON" position and the park brake is set.

"CANCEL" BUTTON: This button turns the system OFF but does NOT control power to the "DUMP" or "RAISE" buttons. Pushing this button will NOT put the system in the TRAVEL mode unless the park brake is released.

"TRAVEL MODE" BUTTON: This button will put the Leveling System in the TRAVEL mode. The ignition must be "ON" for the vehicle to return to proper ride height for traveling.

"DUMP" BUTTON: This button will lower the whole coach by dumping air from the suspension system.

"RAISE" BUTTON: This button will raise the whole coach by adding air to the suspension system.

IMPORTANT: Read "DUMP AND RAISE FUNCTIONS" before using the "DUMP" or "RAISE" buttons.

UP ARROWS (RAISE BUTTONS): These momentary buttons are used for manually operating the air leveling systems. Sides or ends of the vehicle will raise while these buttons are pushed.

DOWN ARROWS (LOWER BUTTONS): These momentary buttons are used for manually operating the air leveling systems. Sides or ends of the vehicle will lower while these buttons are pushed.

INDICATOR LIGHTS

LEVEL SYSTEM ACTIVE LIGHT: ON when the system is active, and flashes during automatic leveling.

DUMP LIGHT: Flashes when "DUMP" button is pushed.

RAISE LIGHT: Flashes when "RAISE" button is pushed.

"EXCESS SLOPE" LIGHT: ON if the leveling system can NOT level the coach.

"TRAVEL MODE" BUTTON LIGHT (RED): Light flashes for 3 seconds after the "TRAVEL MODE" button is pushed.

"TRAVEL MODE" LIGHT (GREEN): ON if the ignition is in the "ON" position, the system is not being used, and there is sufficient air pressure in the suspension. See PREPARATION FOR TRAVEL.

WARNING LIGHTS: Function with the ignition in the "ON" position. ON when the LEVELING SYSTEM ACTIVE LIGHT is ON. See PREPARATION FOR TRAVEL.

LEVELING LIGHTS: One or two yellow lights can be on indicating the side, end or corner of the coach is low.

"NOT IN PARK/BRAKE" LIGHT: ON while the "AIR" button is being pushed if the Park Brake is NOT set. The light will go out when the "AIR" button is released.

MASTER WARNING LIGHT: ON any time the "TRAVEL" light is not ON, if the ignition is in the "ON" position.

CONTROL IDENTIFICATION

PUMP RUN TIME

PUMP RUN TIME

Pump motors used with HWH leveling systems and room extension systems come in 3 different diameters; 3", 3.7" and 4.5". Contact the vehicle manufacturer or HWH for help with identifying the motor size. **It is important that any time the pump runs for more than three minutes with a 3" motor; or six minutes with a 3.7" or 4.5" motor that the motor is allowed to cool for thirty minutes before continuing. Continuous operation of the pump motor without allowing the motor to cool can damage the motor.** For cold weather information see "COLD WEATHER OPERATIONS" below.

The HWH systems with a computer processor monitor the pump run time and will turn the pump off if the run time exceeds a specified time. This time can vary with different systems. Due to available electronics or system design, the pump run time programs will also vary. Leveling systems and room extensions that are not controlled by a system processor have no pump run time protection. **DO NOT run the pump more than three or six minutes without allowing the pump motor to cool for thirty minutes.**

SYSTEM VARIATIONS FOR PUMP RUN TIME

Some systems with rooms run the rooms separate from the system processor. These systems do not monitor pump run time when operating the rooms. **DO NOT run the pump more than three or six minutes without allowing the pump motor to cool for thirty minutes.**

Some systems can be turned back on immediately after the processor turns the pump off. **DO NOT turn the system back on or run the pump without allowing the pump motor to cool for thirty minutes.**

When operating some leveling systems manually or operating the room extensions, the pump will turn off and back on while pushing the control button when the pump run time has been exceeded. **DO NOT continue without allowing the pump motor to cool for thirty minutes.**

With some systems, when the processor has turned the pump off because the run time has been exceeded, power to the HWH system must be turned off and back on before the system will operate. With motorized vehicles, turn the ignition off and back on. With non-motorized vehicles, turn the master power switch for the HWH system off and back on. **DO NOT continue without allowing the pump motor to cool for thirty minutes.**

Some HWH systems are equipped with a lighted reset switch. If the processor turns the pump off because the run time has been exceeded, the light in the reset switch will turn on. The system will not operate until the reset switch is pushed.

DO NOT continue without allowing the pump motor to cool for thirty minutes.



LIGHTED RESET SWITCH

No matter what HWH system is on the vehicle, the pump should not be ran for more than three minutes (3" motors) or six minutes (3.7" or 4.5" motors) without allowing the pump motor to cool for thirty minutes. Continuous operation of the pump motor without allowing the motor to cool can damage the pump motor.

Contact HWH corporation to get specific information about the system in this vehicle.

COLD WEATHER OPERATIONS

HWH leveling and room extension systems are designed to function in cold weather down to 0 degrees Fahrenheit. Below freezing (32 degrees Fahrenheit) the jacks or rooms will operate slower than usual.

For operation in temperatures dropping below -20 degrees Fahrenheit, it is necessary that the system is equipped with oil designed for extreme cold weather application such as a synthetic oil. (Contact HWH for recommendations.)

DO NOT run the pump motor continuously. It is important that any time the pump runs for more than three minutes with a 3" motor; or six minutes with a 3.7" or 4.5" motor that the motor is allowed to cool for thirty minutes before continuing. Continuous operation of the pump motor without allowing the motor to cool can damage the motor. Continuous operation of the pump with slow moving jacks or rooms in cold weather, without allowing the pump motor to cool will cause the pump motor to burn up and damage the pump assembly.

OPERATING PROCEDURES

GENERAL INSTRUCTIONS

Maintain adequate clearance in all directions for vehicles, room extensions, doors, steps, etc.. Vehicle may move in any direction due to raising or lowering of vehicle during leveling, settling of vehicle, equipment malfunction, etc..

The MASTER WARNING LIGHT will be on if an air bag has low pressure and the ignition is in the "ON" position.

WARNING: DO NOT MOVE THE VEHICLE AT SPEEDS IN EXCESS OF 5 MPH IF THE MASTER WARNING LIGHT IS ON.

The "DUMP" and "RAISE" buttons will function with the park brake on or off, if the ignition is in the "ON" or "ACC" position. See AIR DUMP AND RAISE FUNCTIONS section of this manual before using the "DUMP" or "RAISE" buttons.

If the Park Brake is not set, automatic leveling, manual leveling and room extensions will not work.

HWH RESET SWITCH

Refer to the vehicle manufacturer for the location of the HWH reset switch.

Pushing the reset switch will cancel any automatic or manual leveling operation including the SLEEP MODE.

If the ignition is ON when the reset switch is pushed, the system will reset and be ready to start an automatic or manual leveling procedure.

If the ignition is OFF when the reset switch is pushed, the ignition will have to be turned on before any leveling procedure can be started.

PREPARATION FOR TRAVEL

Visually check that the vehicle is at the proper ride height for traveling.

The ignition must be in the "ON" position for the vehicle suspension to be in the travel mode. Also the "TRAVEL MODE" button must be pushed or the park brake released for the suspension to be in the travel mode If the Leveling System was used.

A lit "TRAVEL MODE" light indicates that the HWH Leveling System is in the TRAVEL MODE. It does not indicate that the suspension is at ride height or that the coach is ready to travel.

Pushing the "TRAVEL MODE" button during an automatic leveling sequence will not put the suspension in the travel mode even if the ignition is on. It will stop the auto leveling sequence.

WARNING: IT IS THE OPERATOR'S RESPONSIBILITY TO CHECK THAT THE VEHICLE IS AT PROPER RIDE HEIGHT BEFORE TRAVELING.

Before traveling, the MASTER WARNING light must be off and the "TRAVEL MODE" light must be ON.

NOTE: Low air pressure can turn the green "TRAVEL MODE" light off and turn the MASTER WARNING light on.

Refer to "DUMP" and "RAISE" FUNCTIONS operating procedures when moving the vehicle with the suspension NOT at the proper ride height.

OPERATING PROCEDURES

AUTOMATIC AIR OPERATION

NOTE: The ignition must be in the "ON" or "ACC" position to use the "AIR" button. Once the operation is started, the ignition can be moved to the "OFF" position and the operation will continue.

1. Place the transmission in the proper position for parking and set the park brake. The air leveling system can only be turned on if the ignition is in the "ON" or "ACC" position. Leaving the engine running during leveling is recommended. This will provide a better air supply for leveling. The vehicle will level with the engine shut off, however more time will be required for leveling.

NOTE: If the ignition key is in the "ON" or "ACC" position, the panel will not turn on if the park brake is not set. The "NOT IN PARK/BRAKE" light will be on while the "AIR" button is being pushed.

2. Press the "AIR" button once to start the automatic leveling sequence. The LEVELING SYSTEM ACTIVE LIGHT will flash. The four red WARNING lights on the panel will come on. This indicates that the height control valves have been locked out. The vehicle should not be moved when these lights are on. The system will first exhaust all air from the suspension air bags regardless of the status of the yellow level lights. After approximately 40 seconds, if no yellow light is on, the system will go directly to the sleep mode. If yellow lights are on, the system will add air to air bags to raise the low side or end of the vehicle, starting with any lit side yellow light.

NOTE: Only one or two yellow LEVEL SENSING lights may be ON at one time.

3. SLEEP MODE: When all four yellow level lights are out, the LEVELING SYSTEM ACTIVE LIGHT will flash rapidly. The Leveling System is now in the SLEEP MODE. The four red warning lights will go out. The vehicle's engine/ignition may now be turned OFF. The blue SYSTEM ACTIVE LIGHT will continue to flash rapidly.

4. 30 minutes after the Leveling System enters the SLEEP MODE, the computer will monitor the LEVELING SENSING UNIT for one minute. If no leveling is needed, the computer will continue to monitor the LEVELING SENSING UNIT.

5. If the vehicle needs to be re-leveled, the Leveling System touch panel lights will come on and the leveling procedure will begin. The LEVELING SYSTEM ACTIVE LIGHT will flash. One or two yellow LEVELING LIGHTS will be ON. **The system will re-level the vehicle. When the yellow LEVELING LIGHTS are all out, the LEVELING SYSTEM ACTIVE LIGHT will flash rapidly and return to the SLEEP MODE.** The Leveling System will remain in the SLEEP MODE with the computer monitoring the LEVELING SENSING UNIT, re-leveling the vehicle as needed.

NOTE: The four red warning lights will be on anytime the system is re-leveling the vehicle.

6. The SLEEP MODE will continue until the "CANCEL" button or the "TRAVEL MODE" button is pushed or the park brake is released, if the ignition is in the "ON" position.

EXCESS SLOPE: The system will attempt to level the vehicle for approximately 30 minutes. After the 30 minutes, if a LEVEL SENSING light is still on, the "EXCESS SLOPE" light will come on. The LEVELING SYSTEM ACTIVE light will go out. The system will NOT be in the SLEEP MODE. The "EXCESS SLOPE" light will go out when the ignition is turned off.

NOTE: If the system went EXCESS SLOPE during an automatic leveling procedure, the "EXCESS SLOPE" light will be on any time the ignition is on until the "TRAVEL MODE" button is pushed or the park brake is released with the ignition on.

When the "EXCESS SLOPE" light is on, the "AIR" button will not function. The manual UP or DOWN arrows and the "RAISE" or "DUMP" buttons will function if the ignition is on.

OPERATING PROCEDURES

MANUAL AIR OPERATION

1. Place the transmission in the proper position for parking and set the park brake. The manual raise and lower buttons can only be used if the ignition is in the "ON" or "ACC" position. Running the vehicle engine during leveling is recommended. This will provide a better air supply for leveling. The vehicle will level with the engine shut off, however more time will be required for leveling.

NOTE: The RAISE and LOWER buttons will not function if the system is in automatic leveling or the SLEEP mode. Push the "CANCEL" button with the ignition in the "ON" or "ACC" position to use the manual RAISE and LOWER buttons.

2. The vehicle can be leveled using the RAISE (up arrow) and LOWER (down arrow) buttons on the right half of the panel in conjunction with the yellow LEVEL indicator lights. **Any side to side leveling should be done, if needed, before leveling the vehicle front to rear.**

The yellow LEVEL indicator light indicates that side or end is low. When all yellow lights are out the vehicle is level. Try leveling the vehicle by lowering the high side or end (opposite of the lit yellow level lights). If a level position is not achieved use the RAISE (up arrow) button to raise the low side or end.

3. Turn the ignition to the "OFF" position.

4. Turn the system off.

NOTE: If the "DUMP" or "RAISE" buttons are pushed while manually leveling the vehicle with air and the ignition is in the "ON" position, the system will latch into the dump or raise mode until the "CANCEL" button is pushed or the ignition is turned off.

If any manual button is pushed, the four red warning lights will come on and remain on any time the ignition is in the 'ON' or 'ACC' position.

"DUMP" AND "RAISE" FUNCTIONS

The "DUMP" and "RAISE" functions are provided for operator convenience for purposes such as dumping the air suspension when parked.

WARNING: REREAD CAUTIONS ON THE FIRST PAGE OF THIS MANUAL. THE VEHICLE MAY DROP OR RAISE AND/OR MOVE FORWARD OR BACKWARD WITHOUT WARNING CAUSING INJURY OR DEATH.

The ignition must be in the "ON" or "ACC" position to use the "DUMP" or "RAISE" buttons.

Leave the engine running if the "RAISE" function is to be used. The park brake **DOES NOT** have to be set to use the "DUMP" or "RAISE" buttons.

IMPORTANT: When the "RAISE" button is pushed, the raise feature will latch in and remain on. The vehicle will raise to the maximum capability of the suspension and stay in that position.

When the "DUMP" button is pushed, the dump feature will latch in and stay on. The vehicle will lower until the suspension air bags are completely empty and stay in that position.

To stop a Dump or Raise function when the park brake is set:

A. Push the "CANCEL" button or turn the ignition off. the vehicle will stop raising or lowering and stay in that position.

B. Push the "TRAVEL MODE" button. The vehicle will stop raising or lowering and start to return to ride height.

To stop a DUMP or RAISE function if the park brake is NOT set:

A. If the vehicle is moving and the speed exceeds approximately 10 MPH, the system will return to the Travel Mode. The vehicle should return to ride height.

B. Push the "TRAVEL MODE" button or the "CANCEL" button. The system will immediately return to the "TRAVEL MODE". The vehicle should return to ride height.

C. Turn the ignition off. The vehicle will stop raising or lowering and stay in that position. **DO NOT turn the ignition off if the vehicle is moving.**

DO NOT operate the vehicle for extended distances unless the air suspension is at the proper height for travel. The vehicle can not return to ride height until the "CANCEL" button or "TRAVEL MODE" button is pushed; or the vehicle exceeds 10 MPH, putting the system in the TRAVEL MODE if the park brake is released.

WARNING: IT IS THE OPERATOR'S RESPONSIBILITY TO CHECK THAT THE VEHICLE IS AT PROPER RIDE HEIGHT BEFORE TRAVELING.

OPERATING PROCEDURES

ROOM EXTEND PROCEDURE

NOTE: The park brake must be set before a room can be extended or retracted.

WARNING: OPERATING A ROOM WITH ANY ROOM LOCKING, CLAMPING OR MANUAL RETRACTING DEVICES ATTACHED OR ENGAGED CAN CAUSE PERSONAL INJURY AND VEHICLE DAMAGE. IT IS THE OPERATOR'S RESPONSIBILITY TO ENSURE THAT ALL ROOM LOCKING, CLAMPING OR MANUAL RETRACTING DEVICES ARE DETACHED OR DISENGAGED BEFORE OPERATING THE ROOM.

Refer to vehicle manufacturer for proper sequence of room extension and leveling system operation.

1. Unlock all room-locking devices.

NOTE: If a MANUAL RETRACT WINCH is attached to the room remove it before extending the room.

WARNING: KEEP PEOPLE AND OBSTRUCTIONS CLEAR OF ROOM WHEN OPERATING.

NOTE: Make sure there is adequate clearance to fully extend the room.

2. To extend the room, press and hold the ROOM CONTROL SWITCH in the "EXTEND" position until the room is fully extended.

NOTE: Hold the switch to "EXTEND" three or four seconds after the room is fully extended. This assures proper pressurization of the cylinders. **During normal operation of the room, do not reverse direction of the room until the room is fully extended. If necessary, the direction of the room may be reversed, but watch for binding of the room. If the direction of the room has been reversed, DO NOT re-extend the room until the room has been fully retracted.**

IMPORTANT: Do not hold the ROOM CONTROL SWITCH in the "EXTEND" position for more than ten seconds after the room is fully extended or stops moving. **If either side of the room stops moving, release the room control switch immediately. DO NOT force the room. DO NOT reverse direction of the room, contact HWH Customer Service for assistance 1-800-321-3494.**

NOTE: Releasing the ROOM CONTROL SWITCH will halt the operation of the room.

IMPORTANT: DO NOT USE A ROOM EXTENSION SUPPORT WHEN THE VEHICLE IS SUPPORTED BY THE LEVELING SYSTEM.

OPERATING PROCEDURES

ROOM RETRACT PROCEDURE

NOTE: The park brake must be set before a room can be extended or retracted.

WARNING: KEEP PEOPLE AND OBSTRUCTIONS CLEAR OF ROOM WHEN OPERATING.

Refer to vehicle manufacturer for proper sequence of room extension and leveling system operation.

1. To retract the room press and hold the ROOM CONTROL SWITCH in the "RETRACT" position until the room is fully retracted.

NOTE: Hold the switch to "RETRACT" three or four seconds after the room is fully retracted. This assures proper pressurization of the cylinders. **During normal operation of the room, do not reverse direction of the room until the room is fully retracted. If necessary, the direction of the room may be reversed, but watch for binding of the room. If the direction of the room has been reversed, DO NOT retract the room until the room has been fully extended.**

IMPORTANT: Do not hold the ROOM CONTROL SWITCH in the "RETRACT" position for more than ten seconds after the room is fully retracted or stops moving.

If either side of the room stops moving, release the room control switch immediately. DO NOT force the room. DO NOT reverse direction of the room, contact HWH Customer Service for assistance 1-800-321-3494.

NOTE: Releasing the ROOM CONTROL SWITCH will halt the operation of the room.

2. Engage all room-locking devices.

3. If the room will not retract see the MANUAL ROOM RETRACT PROCEDURE.

IMPORTANT: Room-locking devices should be locked while traveling.

OPERATING PROCEDURES

"UNIVERSAL STRAIGHT OUT" ROOM EXTENSION MECHANISM

MANUAL ROOM RETRACTION PROCEDURES

1. Determine which extend and retract solenoid valves are assigned to the room. Manually open both valves by moving the valve release cams to the open position. See the HYDRAULIC PUMP/ MANIFOLD diagram.

IMPORTANT: ONLY MOVE THE RELEASE CAM IN THE DIRECTION SHOWN. MOVING THE CAM IN THE OPPOSITE DIRECTION CAN DAMAGE THE VALVES.

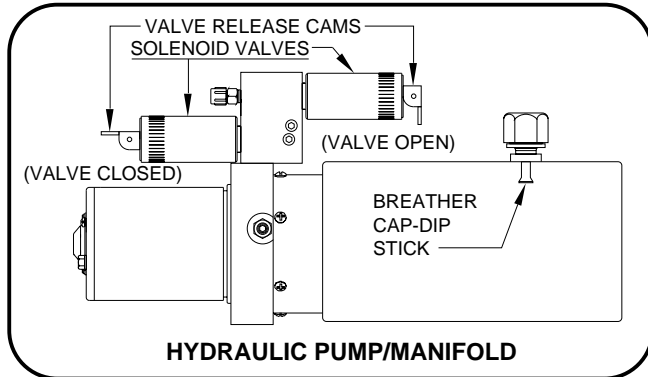

2. Start both threaded rods until resistance is met, one for the front and one for the rear mechanism should be provided.

NOTE: To access the threaded blocks refer to vehicle manufacturer.

3. **Do Not use an impact wrench.** Using wrench provided, a personal wrench or a tire iron with a 1-1/8" opening rotate either mechanism's threaded rod clockwise 6 complete turns.

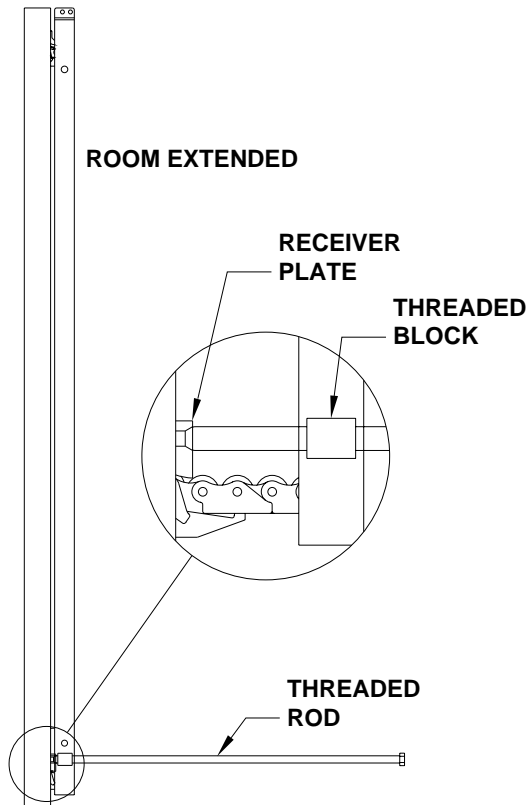

4. Move to the other room extension mechanism, rotate the threaded rod clockwise 12 complete turns.

5. Return to the first room extension mechanism and rotate the threaded rod clockwise 12 complete turns.

6. Repeat steps 4 and 5 alternating from mechanism to mechanism rotating each threaded rod 12 complete turns until room is sealed. (DO NOT exceed 15 ft.lbs) Make sure the room does not bind.

IMPORTANT: If at any stage something is not understood or if the room begins to bind DO NOT force the room, contact HWH Customer Service for assistance 1-800-321-3494.

NOTE: Leave the solenoid valves open and the threaded rods in place until the room has been serviced.

IMPORTANT: DO NOT EXTEND THE ROOM UNTIL THE ROOM HAS BEEN SERVICED. ANY SOLENOID VALVES LEFT OPEN SHOULD BE CLOSED AND THE THREADED RODS SHOULD BE COMPLETELY REMOVED.

NOTE: If there is not enough room to remove both threaded rods completely, alternate backing the threaded rods out and slightly extending the room. Be careful to not extend the room so far that the threaded rods impact the coach wall or the mechanism.

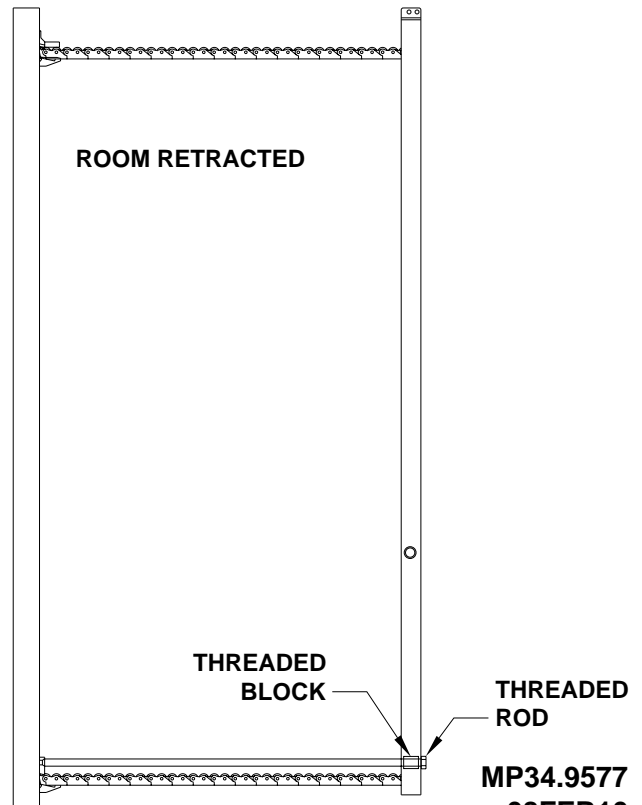

MP34.9577
08FEB10

MAINTENANCE

OIL LEVEL

All maintenance should be done as part of the normal servicing of the coach.

The oil level should be checked when the vehicle is first purchased and then once every two years. More often if there is an oil leak in the system.

The rooms should be fully extended to check the oil level. The oil reservoir is part of the pump / manifold assembly. The oil level is checked and filled through the breather cap. Clear any dirt away from the breather / filler cap before removing. The oil level should be within one inch of the top of the reservoir. Most breather caps have a dipstick.

NOTE: Overfilling the tank can cause leakage of oil through the breather cap.

FLUID: HWH Specialty Hydraulic Oil is recommended. In an emergency Dexron automatic transmission fluid can be used. **NOTE:** Dexron automatic transmission fluid contains red dye and can cause staining should a leak occur. **DO NOT USE** brake fluid or hydraulic jack fluid. Use of these can damage seals.

ELECTRICAL SYSTEM

The batteries should be in good condition and fully charged. Weak batteries can cause erratic operation. Battery cable terminals and battery posts and connections should be kept clean.

All electrical connections, especially ground connections, should be clean, tight, free from corrosion and protected from weathering.

ROOM EXTENSIONS

The HWH room mechanisms need no maintenance. **DO NOT** grease or lubricate any parts of the HWH mechanism.

Any visible mechanism can be kept clean by washing with water. Refer to the vehicle manufacturer for correct maintenance of the room seals.

VISUAL INSPECTION

Periodically inspect the system for oil leaks and damaged or missing parts, such as pivot bolts or springs. Check the hydraulic lines and wiring for damage and wear. Check that the jacks do not interfere with any parts of the vehicle when they are in the "STORE" position.

The system will operate better if kept clean and free from caked on mud or ice.

OPERATIONAL CHECK

Review the OPERATOR MANUAL. Run the system according to the SYSTEM OPERATION Section. Note any abnormal operation.

Review the "ROOM RETRACTION" Section. Make sure the rooms will fully retract.

Check that all lights work according to the "INDICATOR LIGHT" Section. Correct function of the red "WARNING" light is important.

MAINTENANCE

NOT IN PARK/BRAKE CHECK

WARNING: WHEN MAKING THIS CHECK, BLOCK THE COACH WHEELS SECURELY SO THE COACH CANNOT ROLL FORWARD OR BACKWARD.

Switch the ignition to the "ON" or "ACC" position.
Release the park brake. Push and hold the "AIR" button.
The "NOT IN PARK/BRAKE" light should come on while pushing the "AIR" button. The system should not function.
Release the "AIR" button and set the park brake. Push the "AIR" button. The system should start to level.

If any of the above checks or inspections reveal a problem or if there are other problems or questions, consult a qualified RV repair center, your vehicle or coach manufacturer, or HWH CORPORATION for service or repair.

WINTER WEATHER DRIVING

Anti-icing / deicing agents when splashed on your vehicle, continue to absorb moisture from the air even after they have dried. This can facilitate corrosion of metallic components, such as HWH jacks.

To help reduce the corrosion of jacks after exposure to anti-icing / deicing agents, thoroughly wash jacks with warm soapy water.

INSTRUCTION SHEET

SENSING UNIT MAINTENANCE/SERVICE

REMOTE MOUNTED "POTTED" ELECTRONIC SENSING UNIT

SENSING UNIT ACCURACY TOLERANCE

The sensing unit has an accuracy tolerance of ± 5.4 inches front to rear and ± 1 inch side to side on a 36 foot vehicle. Typical leveling results will be better.

SENSING UNIT ADJUSTMENT / WITH ADJUSTING ENHANCEMENT

Level the vehicle by placing a bubble level in the center of the freezer floor or upon whichever surface within the vehicle that is to be level. It is best if the level is placed close to the mounting area of the sensing unit. Using the Leveling System and the bubble level, ignoring the yellow LEVEL lights on the Touch Panel, level the vehicle until the bubble is centered.

With the vehicle level according to the bubble level, if there are no yellow lights lit on the Touch Panel, the sensing unit is properly adjusted. If there are yellow LEVEL lights lit on the Touch Panel, manual adjustments to the Sensing Unit are needed.

The ignition (motorized units) or master power switch (towable units) must be on. Remove the "Adjusting Enhancement Cap". **DO NOT LOSE THIS CAP.** There is a small pin beneath the cap. Use a jumper wire with an alligator clip to apply a ground to the pin. This will make the sensing unit very sensitive. The yellow lights may "jump" around while adjusting the sensing unit. Let the lights settle down after each adjustment. Small, gentle turns will work best. Turn mounting screws 1 and 3 to adjust the sensing unit. Turn screws as instructed to turn out all the yellow LEDs. When all the LEDs are out, remove the jumper wire and replace the adjusting enhancement cap. **DO NOT** over tighten.

Move the vehicle to an unlevel position and level the vehicle according to the yellow level sensing lights on the touch panel. Readjust if necessary.

IMPORTANT: THE SENSING UNIT MOUNTING SPRINGS SHOULD BE COMPRESSED ABOUT 1/2 THEIR FREE LENGTH. SCREW NUMBER 2 SHOULD NOT BE TURNED WHILE ADJUSTING THE SENSING UNIT. AFTER ADJUSTING THE SENSING UNIT, BUMP THE SENSING UNIT TO SEE THAT IT IS SETTLED TIGHT AGAINST ALL THREE SCREW HEADS AND STILL INDICATES THAT THE UNIT IS LEVEL.

NOTE: If opposing LED's are lit, there is a problem with the Sensing Unit.

If LED (A) is lit: Tighten adjustment screw number 1 until the LED is off.

If LED (C) is lit: Loosen adjustment screw number 1 until the LED is off.

If LED (B) is lit: Loosen adjustment screw number 3 until the LED is off.

If LED (D) is lit: Tighten adjustment screw number 3 until the LED is off.

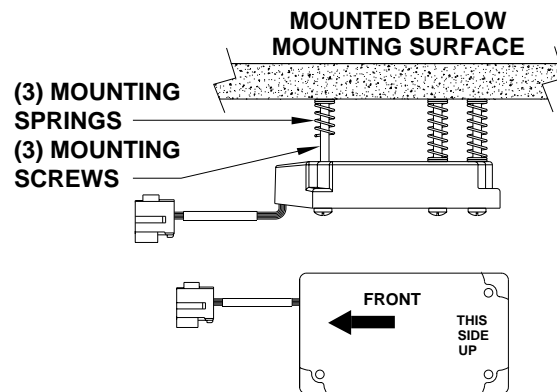
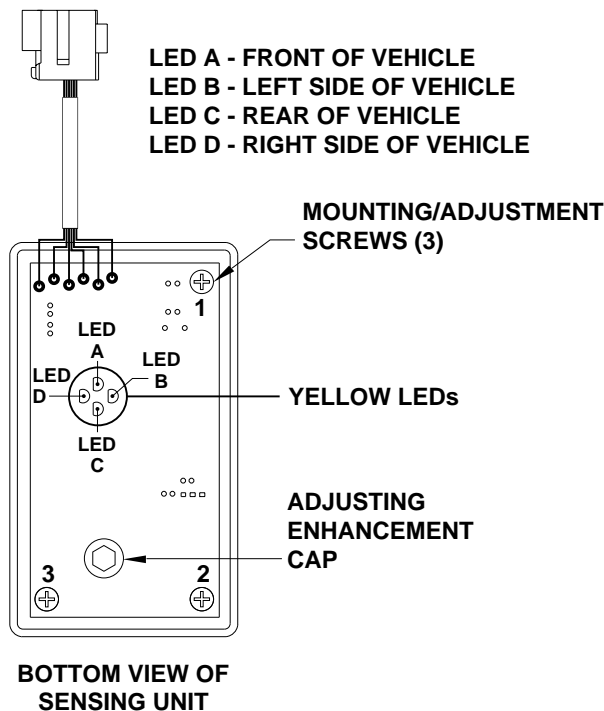

FRONT AIR MANIFOLD PRESSURE REGULATOR ADJUSTMENT

TIFFIN MOTOR HOMES WITH SINGLE STEP AIR LEVELING

WARNING: DO NOT CRAWL UNDER THE VEHICLE WHEN SUPPORTED WITH THE SUSPENSION AIR BAGS. PROPERLY SUPPORT THE VEHICLE FRAME BEFORE CRAWLING UNDER THE VEHICLE TO ADJUST THE FRONT MANIFOLD AIR REGULATOR OR TO PERFORM OTHER WORK.

NOTE: It is best if the vehicle is on a flat level surface when adjusting the regulator.

1. Remove the 1/8 inch pipe plug from the regulator. It is recommended to drain the air from the air tanks before removing the plug. Removing the plug will exhaust the air from the air tanks. Install the pressure gauge assembly onto the regulator. DO NOT use Teflon tape or pipe sealant on the gauge assembly threads. DO NOT over tighten the gauge assembly. See the diagram below. Save the 1/8 inch plug so it can be reinstalled after adjustment of the regulator is complete.

IMPORTANT: MAKE SURE THE AIR TANKS ARE AT FULL PRESSURE BEFORE ADJUSTING THE REGULATOR. YOU SHOULD HEAR THE AIR DRYER PURGE VALVE RELEASE WHEN THE AIR TANKS ARE FULL.

2. To unlock the adjusting knob of the front air manifold regulator, pull the knob out, away from the main body of the regulator.
3. Turn the regulator adjustment knob counterclockwise until the gauge reads 0 psi. Turn the knob clockwise until the gauge reads 50 psi. It is important to turn the regulator down, then back up to properly adjust the regulator.
4. Push and hold the HWH touch panel front DOWN ARROW button until the front air bags are empty. Check the air bags. Repeat this with the rear DOWN ARROW button. Again, check the air bags.
5. Push and hold the HWH touch panel front UP ARROW button until the front of the vehicle stops rising. Check to make sure both front air bags are filling with air.
6. Measure from the ground to the trim line of the vehicle at the approximate center of both front wheel wells. Use a piece of tape to mark the measuring points. It is important to measure at the same place each time. Record the measurements.
7. Adjust the regulator up 5 psi from 50 psi. to 55 psi. Remember to support the vehicle before crawling under the vehicle.
8. Again, push and hold the front UP ARROW button until the front of the vehicle stops rising. Measure at the trim line again and record the measurement.
9. Repeat this procedure, increasing the regulator pressure by 5 psi each time until the front of the vehicle does not raise at all when the UP ARROW button is pushed.
10. Leave the regulator pressure at the final setting and push the adjustment knob in to lock the regulator setting.
11. Remove the pressure gauge assembly from the regulator and re-install the 1/8 inch plug. Use Teflon tape to seal the threads. Be careful to not get Teflon tape inside the regulator.
12. After the regulator is adjusted, refer to Manual ML46839, Performance Check List for 2000 series Single Step Air Leveling System to fully test the system.

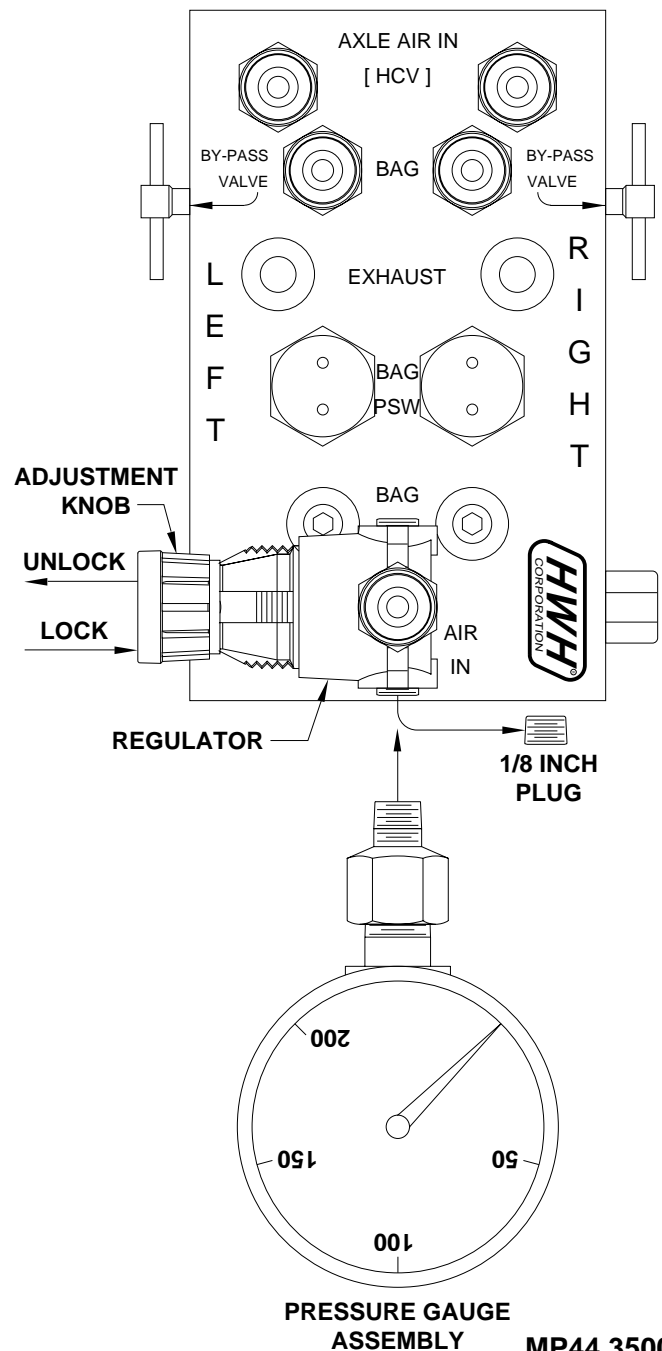

MP44.3500
04JUN18

HYDRAULIC LINE CONNECTION DIAGRAM

MULTIPLE EXTENSIONS

ROOM 1 (DRIVER SIDE FRONT)
**EXTEND ROOM TO
 CHECK OIL LEVEL**

SEE HYDRAULIC LINE
 CONNECTION DIAGRAM
 UNIVERSAL STRAIGHT OUT
 ROOM MECHANISM

ROOM 2 (PASSENGER SIDE FRONT)
**EXTEND ROOM TO
 CHECK OIL LEVEL**

SEE HYDRAULIC LINE
 CONNECTION DIAGRAM
 UNIVERSAL STRAIGHT OUT
 ROOM MECHANISM

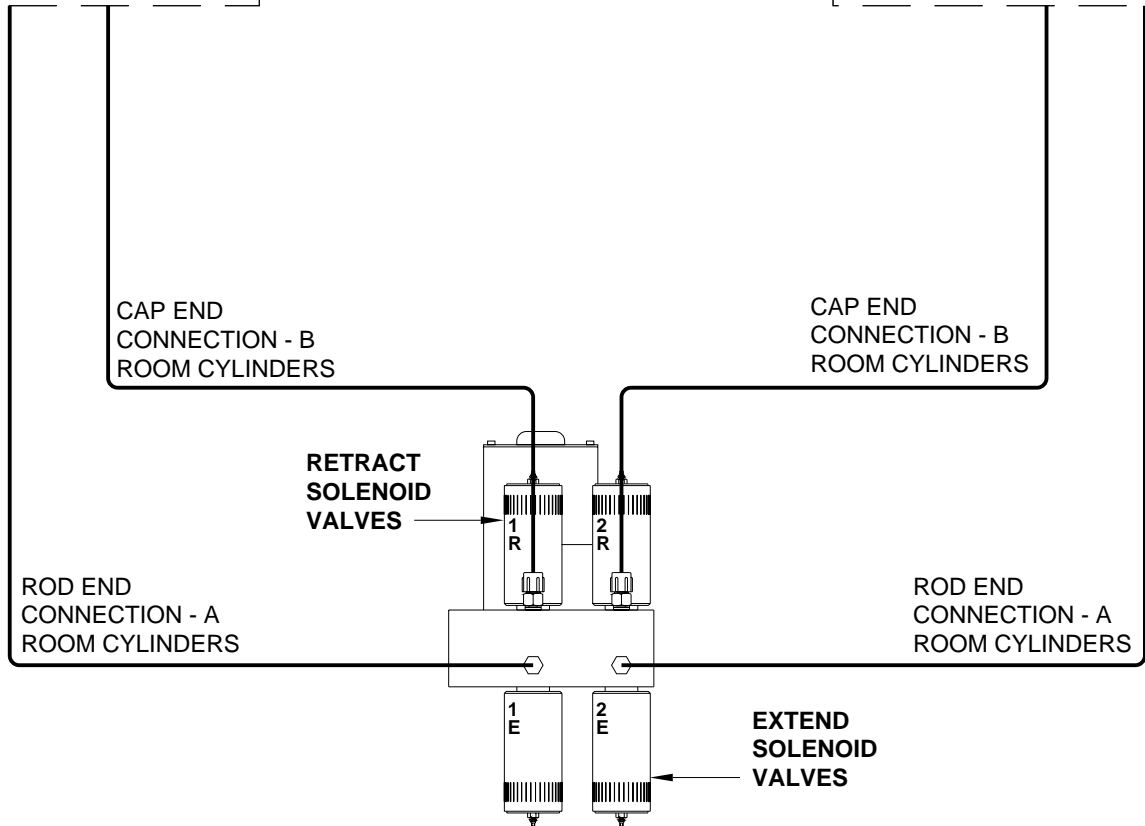

VALVE FUNCTION

- 1R - ROOM CYLINDER RETRACT - ROOM EXTEND
- 1E - ROOM CYLINDER EXTEND - ROOM RETRACT
- 2R - ROOM CYLINDER RETRACT - ROOM EXTEND
- 2E - ROOM CYLINDER EXTEND - ROOM RETRACT

**IMPORTANT: DO NOT SWAP CAP OR ROD
 HOSES BETWEEN ROOMS OR DAMAGE
 TO EQUIPMENT MAY RESULT.**

AIR LINE CONNECTION DIAGRAM

4 - POINT AIR LEVELING SYSTEM

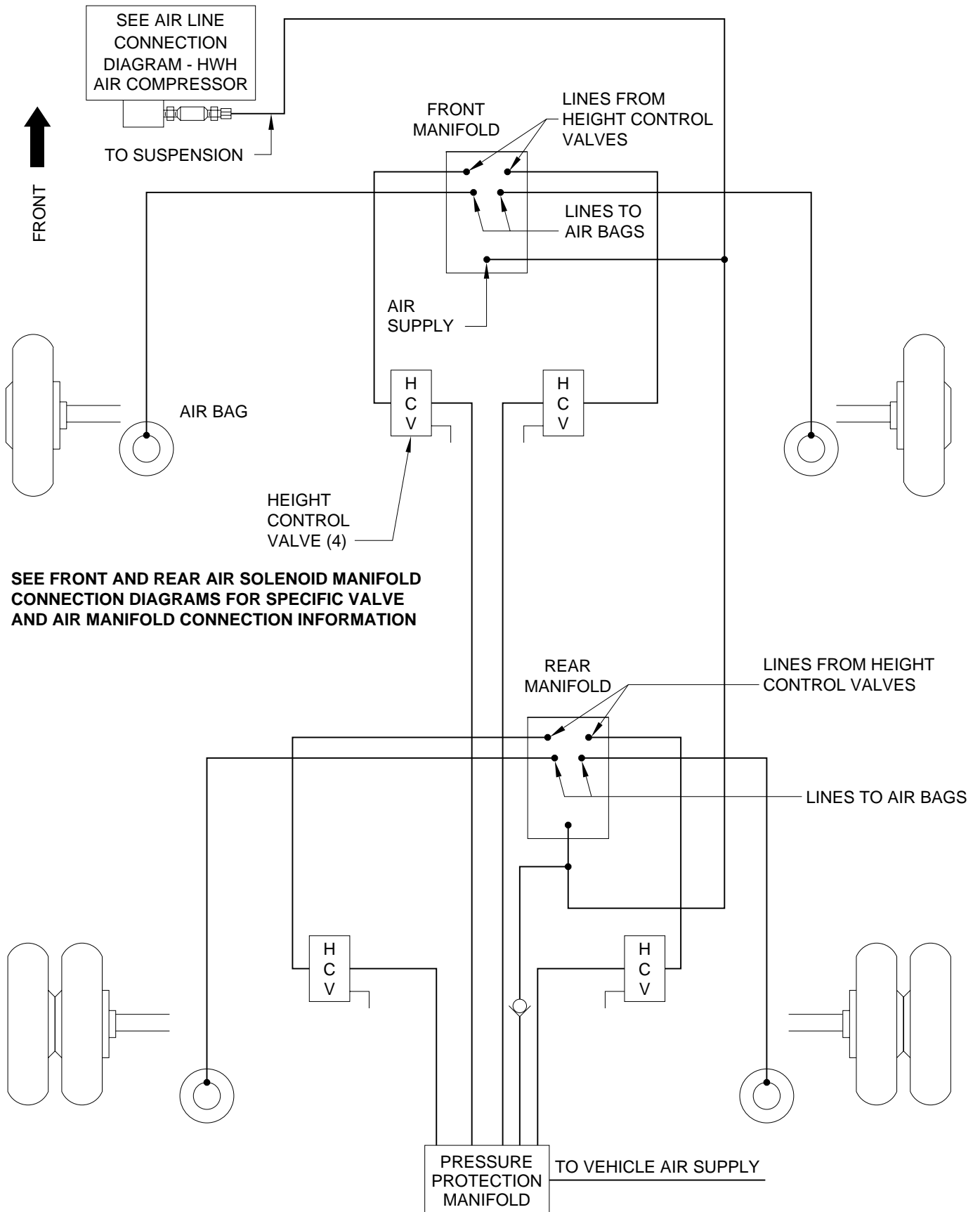

AIR LINE CONNECTION DIAGRAM 4-POINT LEVELING SYSTEM SCHEMATIC PRESSURE SWITCHES FRONT AND REAR

SEE AIR LINE CONNECTION
DIAGRAM - HWH AIR
COMPRESSOR SCHEMATIC

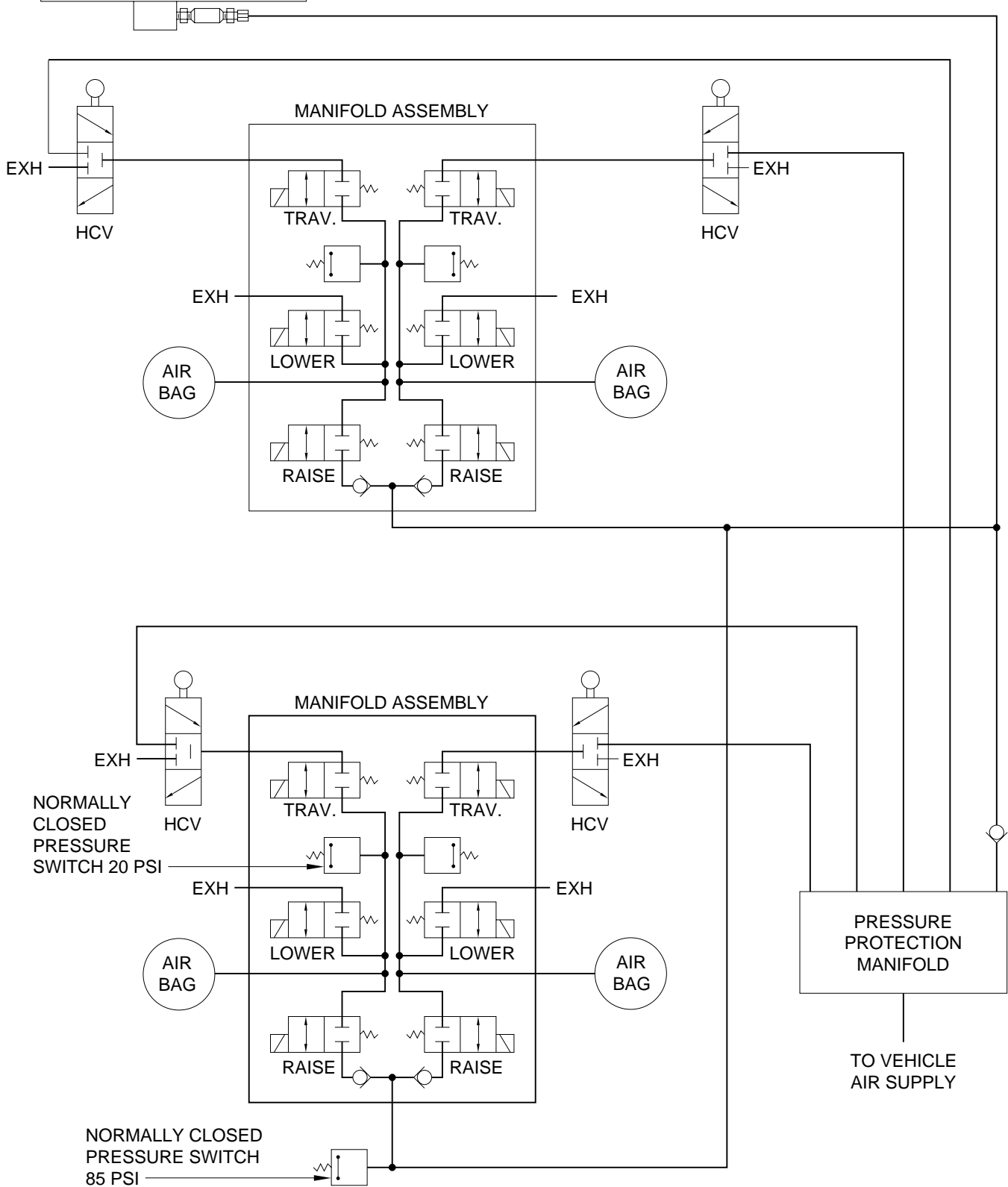

AIR SOLENOID MANIFOLD 6 VALVE WITH TWO PRESSURE SWITCHES AND BY-PASS VALVES

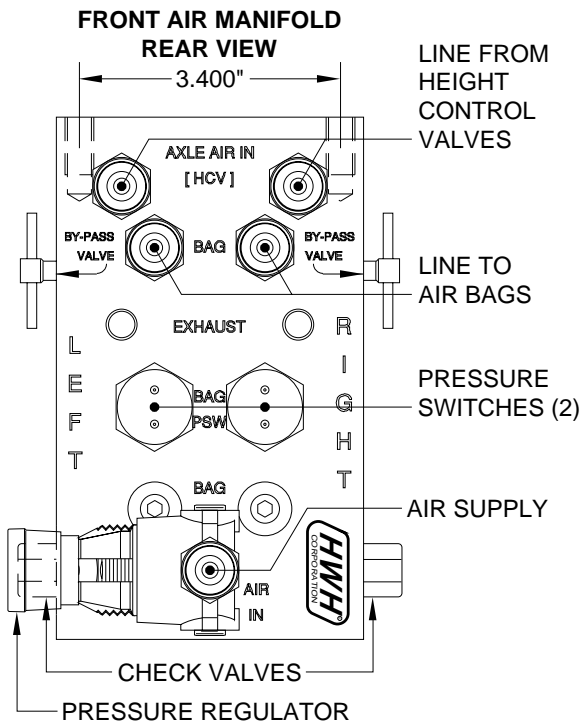

**NOTE: I/O MODULE NOT SHOWN
SEE ELECTRICAL CONNECTION DIAGRAM
FRONT AIR I/O MODULE - PAGE 2 OF 2**

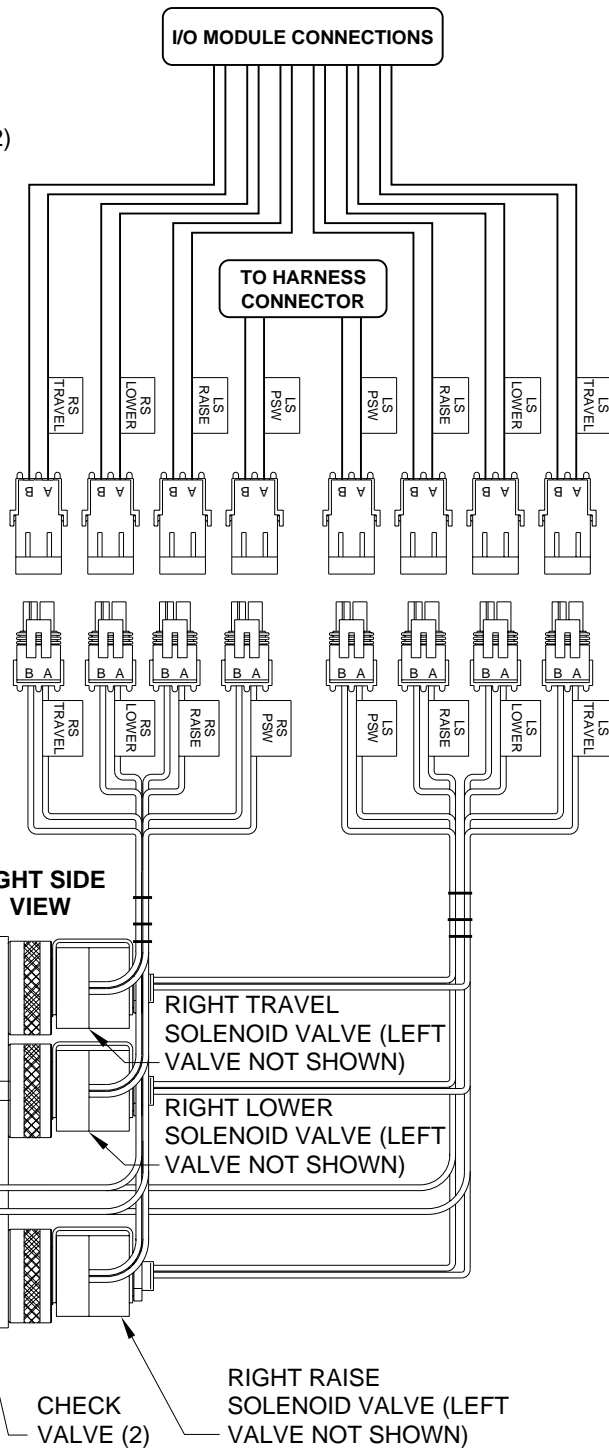

IMPORTANT: LEFT AND RIGHT CONNECTIONS MUST BE MAINTAINED AS SHOWN. GROUND SUPPLY WIRES FOR AIR PRESSURE SWITCHES AND AIR SOLENOID VALVES CANNOT BE INTERCHANGED.

- MOUNTING HOLES
- LINE FROM HEIGHT CONTROL VALVE (MAY BE TEED TOGETHER IF ONE HCV IS USED)
- LINE TO AIR BAGS (2 LEFT AND RIGHT)
- EXHAUST PORTS (2 LEFT AND RIGHT)
- PRESSURE SWITCH 20 PSI (2 LEFT AND RIGHT)
- AIR SUPPLY
- PRESSURE REGULATOR (REGULATOR WILL NOT BE PRESENT ON 2014 MODEL COACHES OR NEWER)

AIR SOLENOID MANIFOLD 6 VALVE WITH THREE PRESSURE SWITCHES AND BY-PASS VALVES

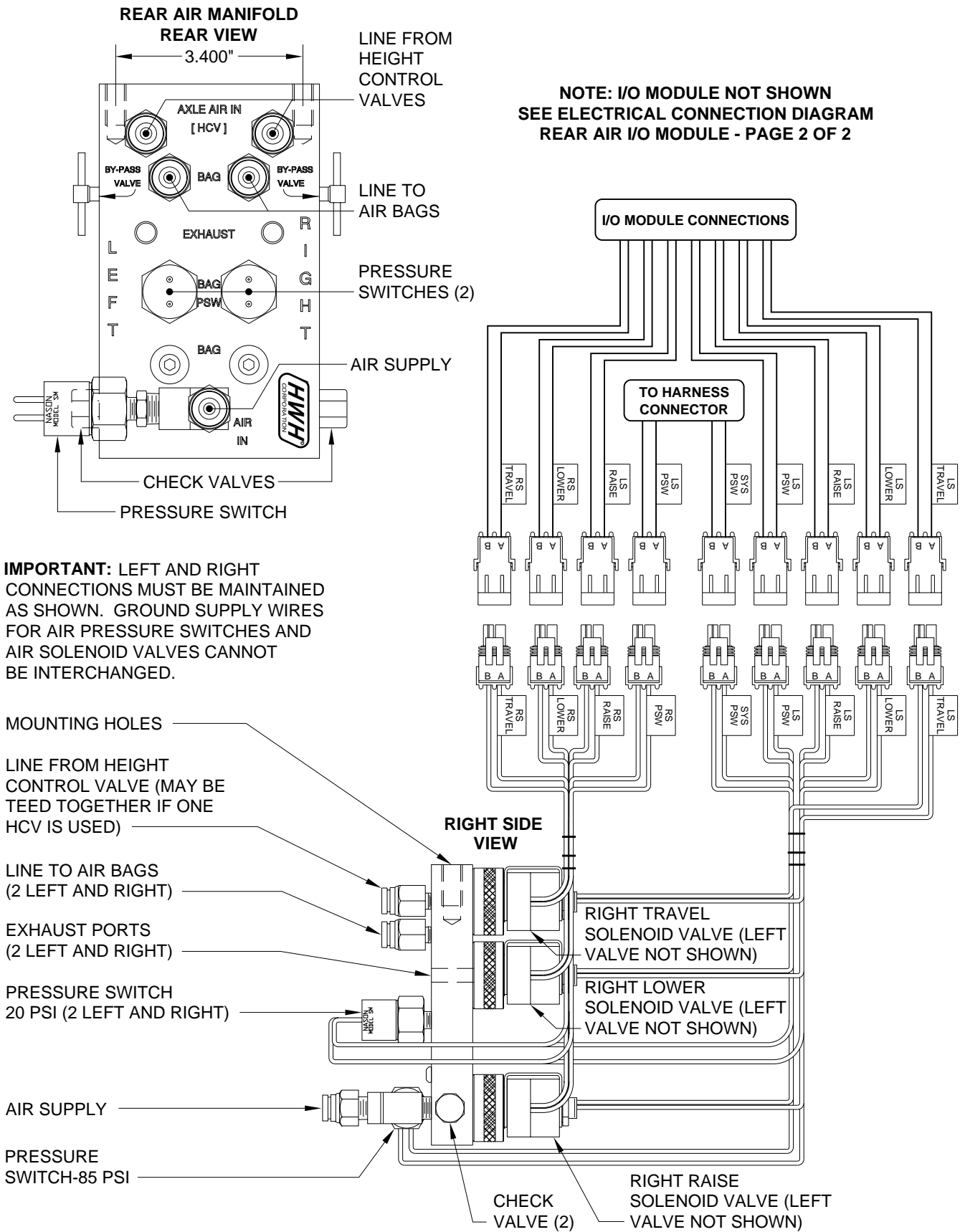

AIR LINE CONNECTION DIAGRAM HWH AIR COMPRESSOR

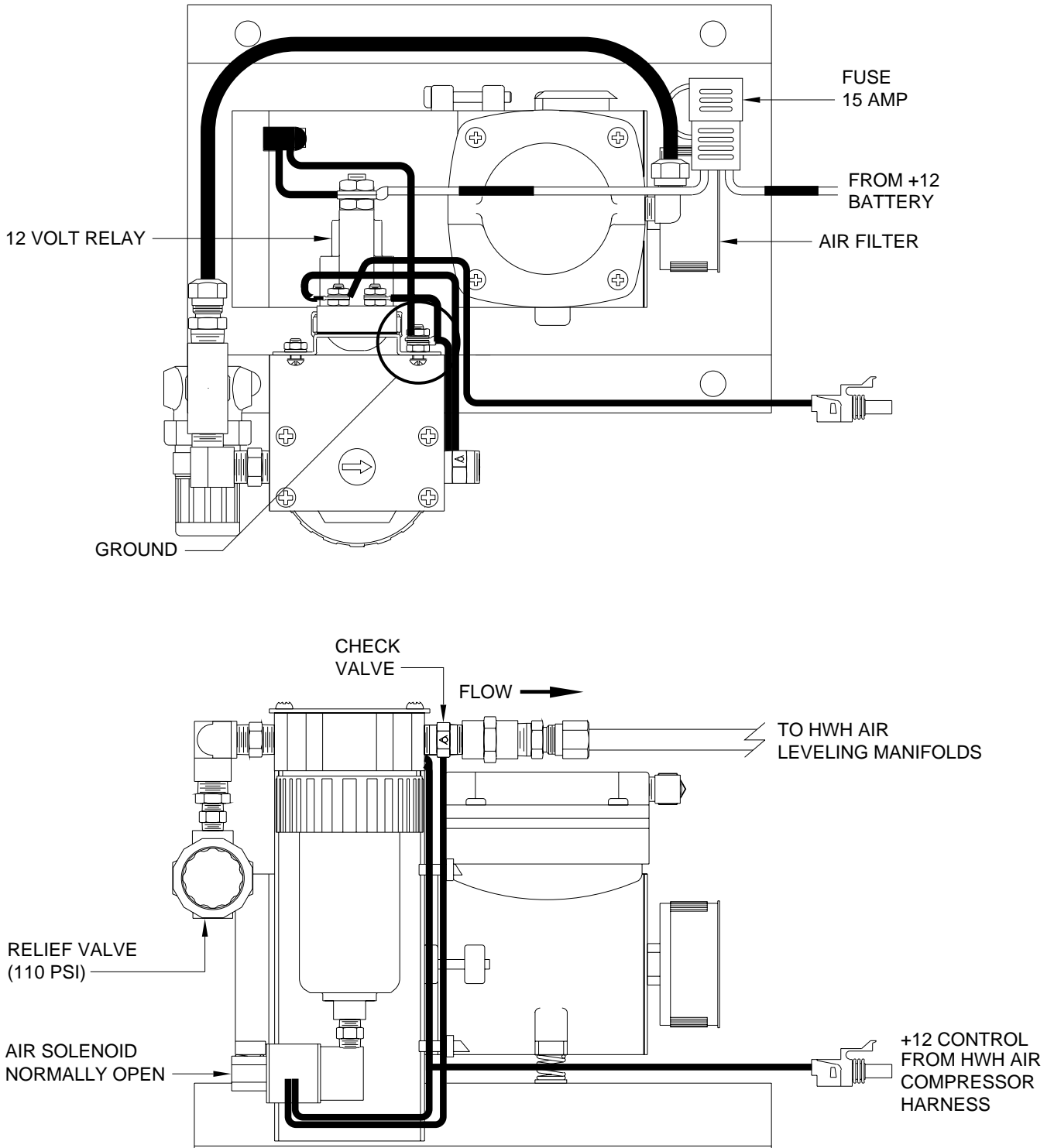

AIR LINE CONNECTION DIAGRAM

HWH AIR COMPRESSOR SCHEMATIC

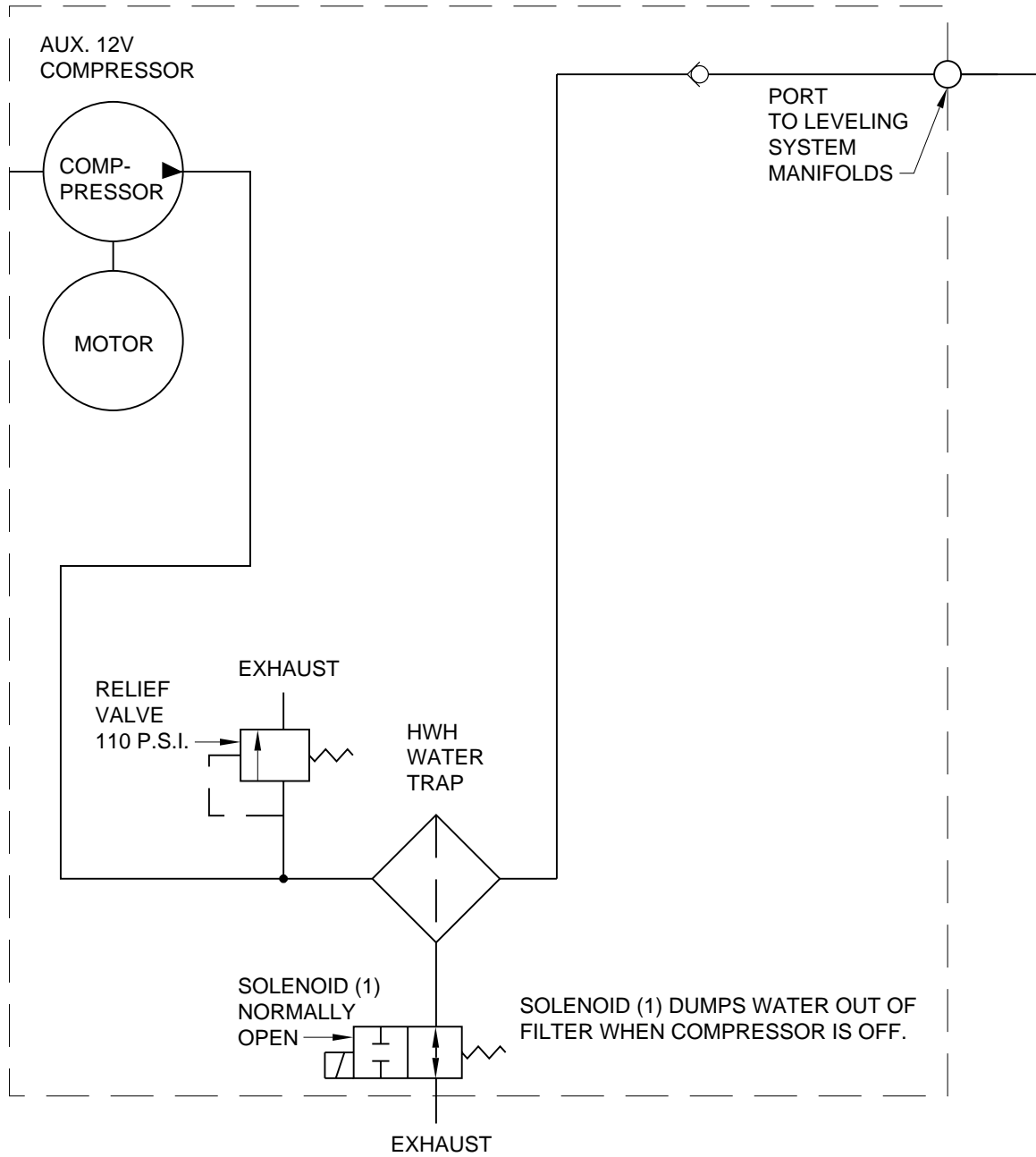

ELECTRICAL CONNECTION DIAGRAM

700 SERIES AIR LEVELING

HARNESS ROUTING

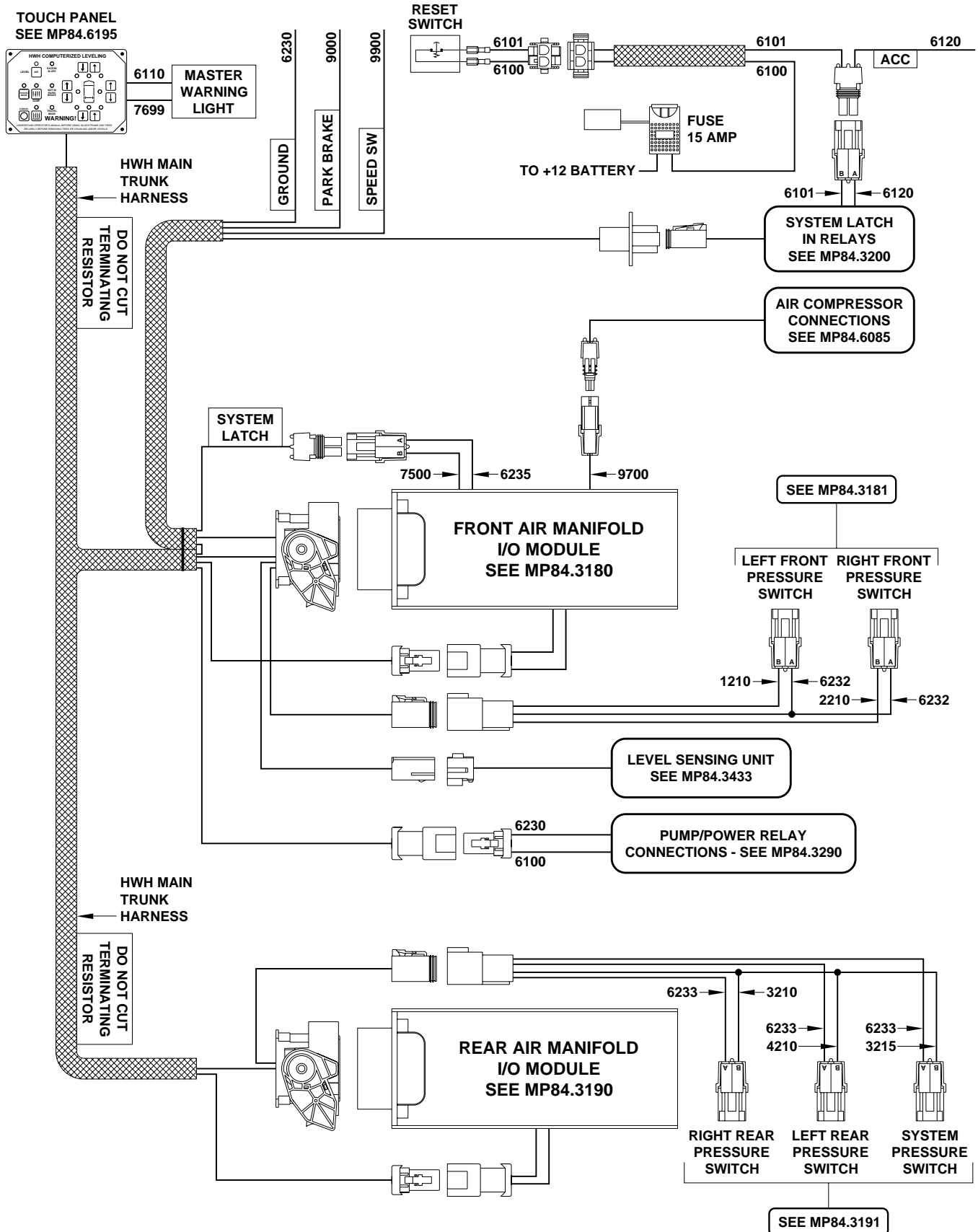

ELECTRICAL CONNECTION DIAGRAM

700 SERIES FRONT AIR MANIFOLD MULTIPLEXED I/O MODULE

WIRE CONNECTION INFORMATION - PAGE 1 OF 2

*** EARLY MODULES MAY NOT HAVE LATCH LED**

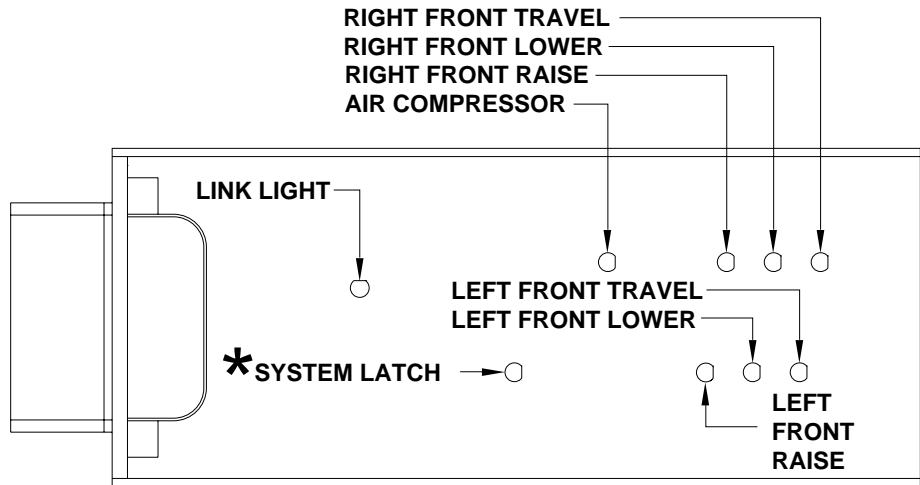

FRONT VIEW OF I/O MODULE CONNECTOR

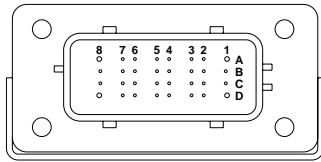

A LIT RED LED INDICATES THERE SHOULD BE +12 VOLTS ON THE CORRESPONDING WIRE.

LINK LIGHT: LINK LIGHT FLASHING INDICATES PROPER COMMUNICATION BETWEEN THE I/O MODULE AND THE TOUCH PANEL. LINK LIGHT ON SOLID OR OFF INDICATES A FAILURE.

PIN #	WIRE COLOR	WIRE NUMBER	WIRE DESCRIPTION AND FUNCTION
A1	RED	6120	SWITCHED +12 ACC FROM IGNITION SWITCH
A2	YELLOW	N/A	CAN HIGH COMMUNICATION WIRE
A3 THRU A5			NO CONNECTION
A6	BLACK	2210	SW GND FROM RIGHT FRONT AIR PRESS. SWITCH - LOW PRESSURE
A7 AND A8			NO CONNECTION
B1	RED	6122	+12 VOLT POWER TO THE TOUCH PANEL
B2	GREEN	N/A	CAN LOW COMMUNICATION WIRE
B3 THRU B8			NO CONNECTION
C1	RED	6121	+12 VOLT POWER FOR LEVEL SENSING UNIT
C2	N/A	N/A	SHIELD WIRE FOR GREEN & YELLOW CAN COMMUNICATION WIRES
C3	WHITE	6231	GROUND FOR LEVEL SENSING UNIT
C4	BLACK	0400	SWITCHED GROUND FROM LEVEL SENSING UNIT - REAR LOW
C5			NO CONNECTION
C6	BLACK	9900	+12 FROM SPEED SWITCH - LOW SPEED
C7			NO CONNECTION
C8	BLACK	0300	SWITCHED GROUND FROM LEVEL SENSING UNIT - RIGHT SIDE LOW
D1	RED	6102	SWITCHED +12 BATTERY FROM LATCH IN RELAYS
D2	WHITE	6232	GROUND FOR AIR MANIFOLD PRESSURE SWITCHES
D3	WHITE	** 6230	SYSTEM GROUND FOR I/O MODULES AND TOUCH PANEL
D4			NO CONNECTION
D5	BLACK	1200	SW GND FROM LEFT FRONT AIR PRESS. SWITCH - LOW PRESSURE
D6	BLACK	0100	SWITCHED GROUND FROM LEVEL SENSING UNIT - LEFT SIDE LOW
D7	BLACK	0200	SWITCHED GROUND FROM LEVEL SENSING UNIT - FRONT LOW
D8	BLACK	9000	SWITCHED GROUND FROM PARK BRAKE SWITCH - PARK BRAKE ON

****** 6230 GROUND WIRE IS NOT PRESENT ON NEWER SYSTEMS.

ELECTRICAL CONNECTION DIAGRAM

700 SERIES FRONT AIR MANIFOLD MULTIPLEXED I/O MODULE

WIRE CONNECTION INFORMATION - PAGE 2 OF 2

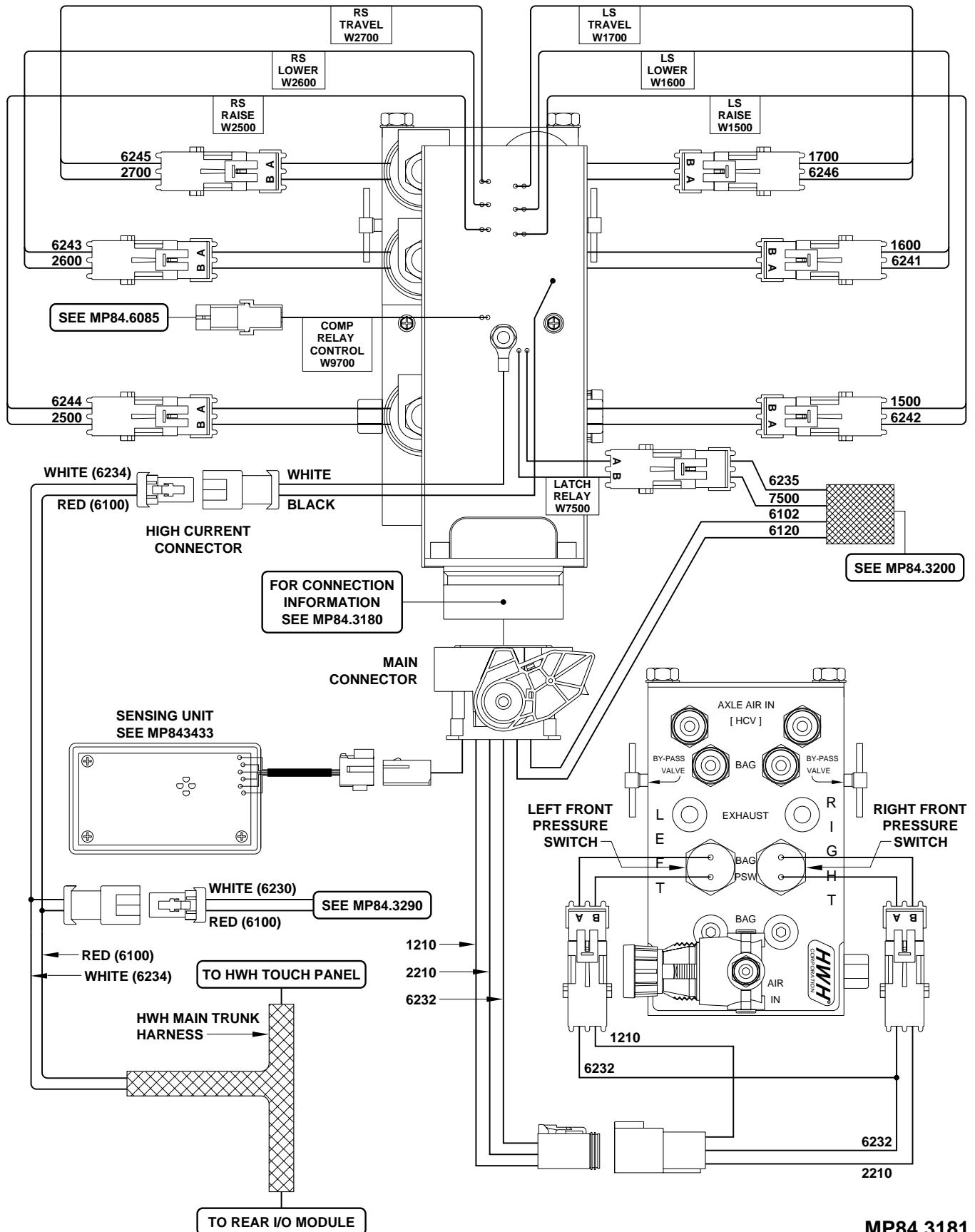

ELECTRICAL CONNECTION DIAGRAM

700 SERIES REAR AIR MANIFOLD MULTIPLEXED I/O MODULE

WIRE CONNECTION INFORMATION - PAGE 1 OF 2

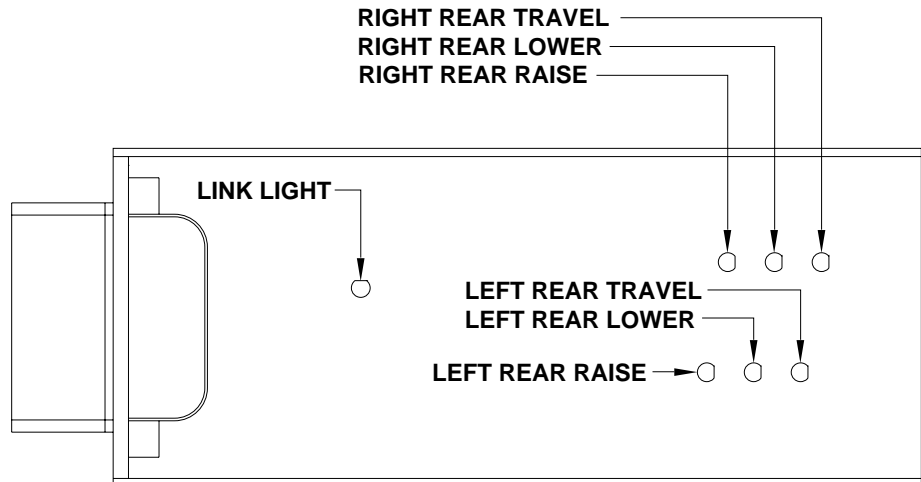

FRONT VIEW OF I/O MODULE CONNECTOR

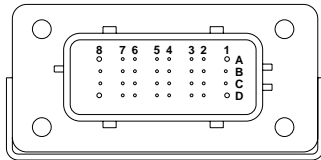

A LIT RED LED INDICATES THERE SHOULD BE +12 VOLTS ON THE CORRESPONDING WIRE.

LINK LIGHT: LINK LIGHT FLASHING INDICATES PROPER COMMUNICATION BETWEEN THE I/O MODULE AND THE TOUCH PANEL. LINK LIGHT ON SOLID OR OFF INDICATES A FAILURE.

PIN #	WIRE COLOR	WIRE NUMBER	WIRE DESCRIPTION AND FUNCTION
A1			NO CONNECTION
A2	YELLOW	N/A	CAN HIGH COMMUNICATION WIRE
A3 THRU A5			NO CONNECTION
A6	BLACK	3210	SW GND FROM RIGHT REAR AIR PRESS. SWITCH - LOW PRESSURE
A7 AND A8			NO CONNECTION
B1			NO CONNECTION
B2	GREEN	N/A	CAN LOW COMMUNICATION WIRE
B3 THRU B7			NO CONNECTION
B8	BLACK	3215	SW GND FROM SYSTEM PRESSURE SWITCH - LOW PRESSURE
C1			NO CONNECTION
C2	N/A	N/A	SHIELD WIRE FOR GREEN & YELLOW CAN COMMUNICATION WIRES
C3 THRU C8			NO CONNECTION
D1	RED	6122	+12 POWER FOR I/O MODULE
D2	WHITE	6233	GROUND FOR AIR MANIFOLD PRESSURE SWITCHES
D3	WHITE	6230	SYSTEM GROUND FOR I/O MODULE
D4			NO CONNECTION
D5	BLACK	4210	SW GND FROM LEFT REAR AIR PRESS. SWITCH - LOW PRESSURE
D6 THRU D8			NO CONNECTION

ELECTRICAL CONNECTION DIAGRAM
700 SERIES REAR AIR MANIFOLD MULTIPLEXED I/O MODULE
WIRE CONNECTION INFORMATION - PAGE 2 OF 2

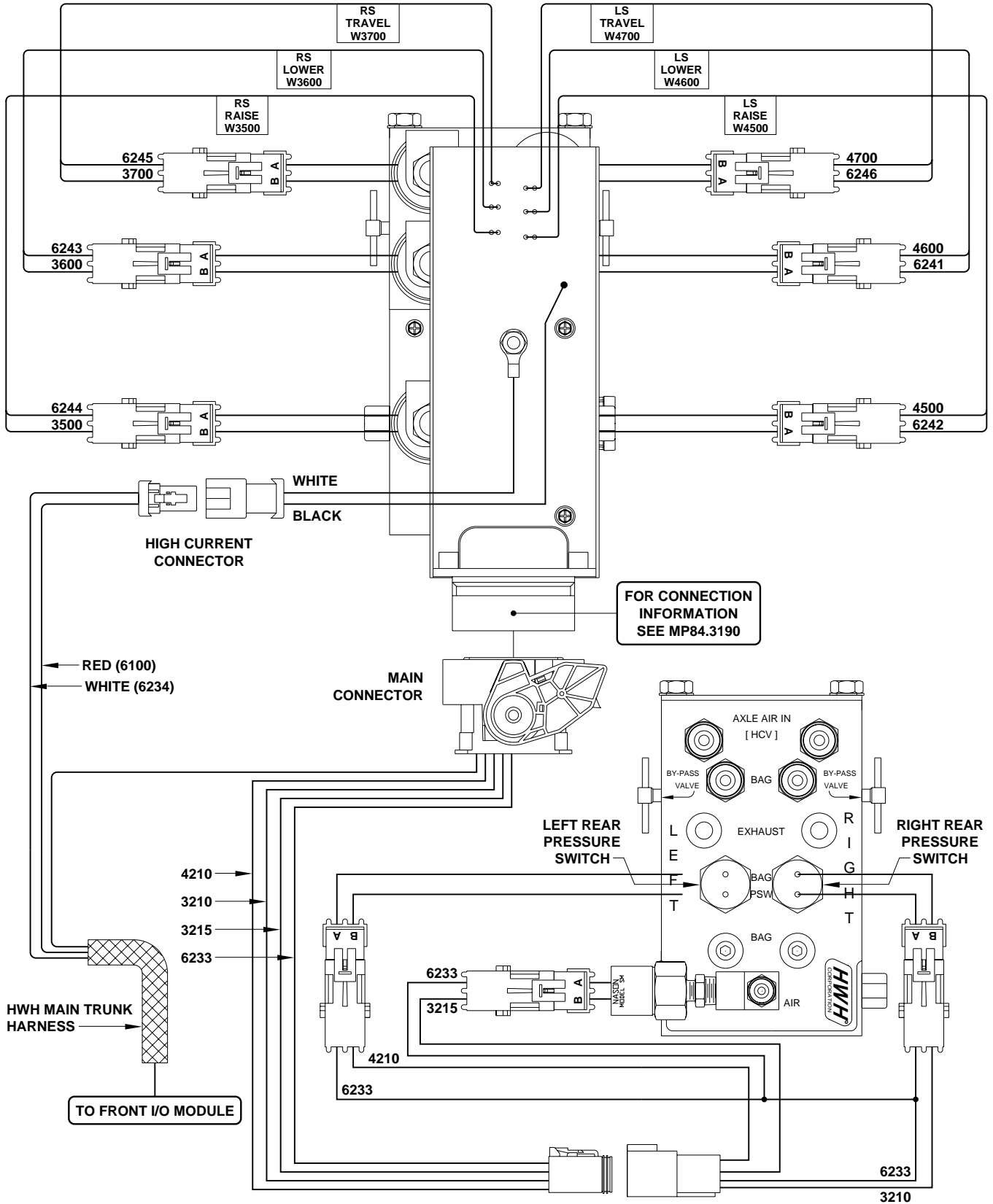

ELECTRICAL CONNECTION DIAGRAM LEVELING SYSTEM LATCH IN RELAYS

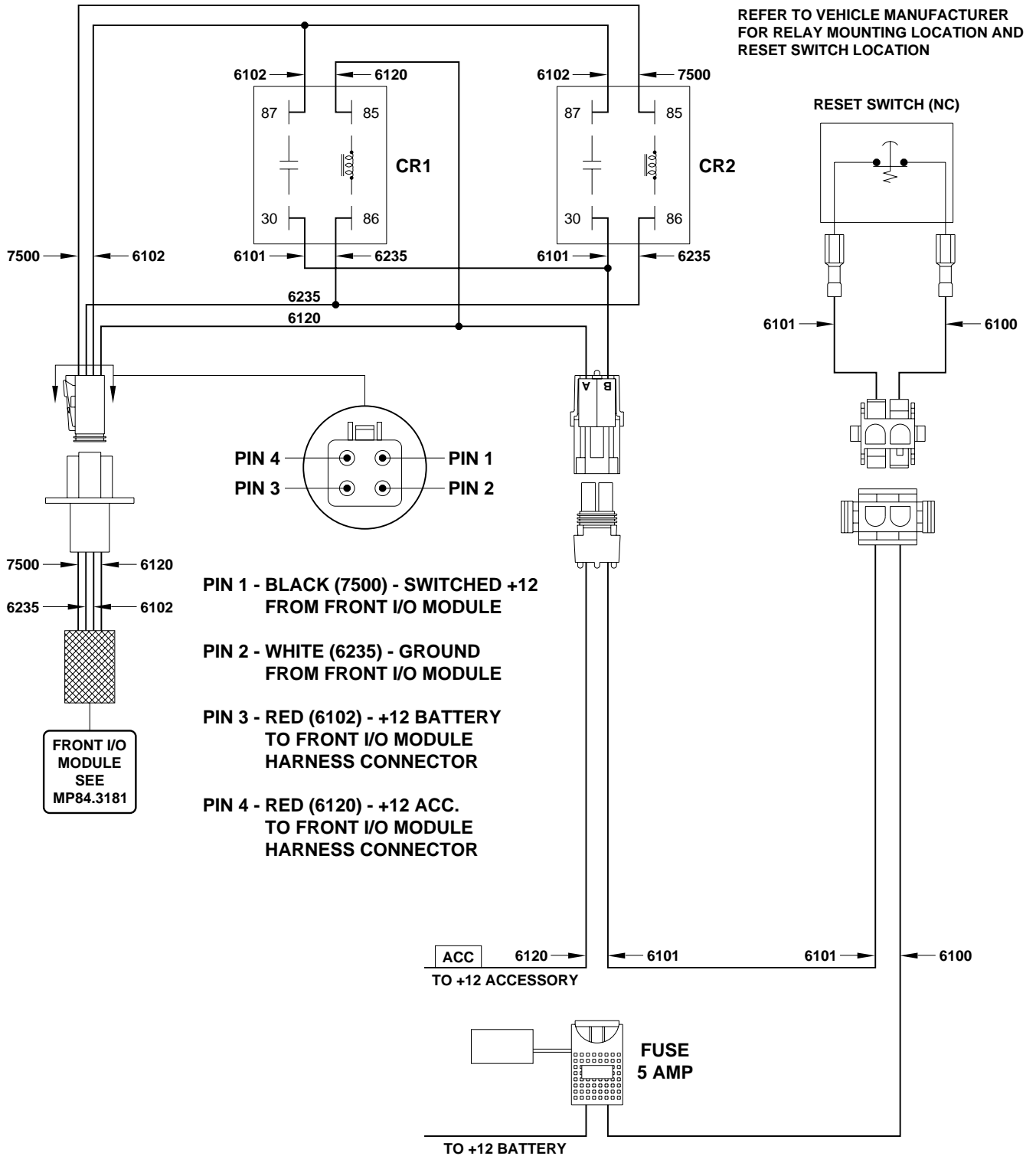

ACC. AND BATTERY CONNECTIONS
BY VEHICLE MANUFACTURER

ELECTRICAL CONNECTION DIAGRAM

TWO ROOM EXTENSIONS

ROOM EXTENSION HYDRAULIC MANIFOLD / POWER / PUMP RELAY

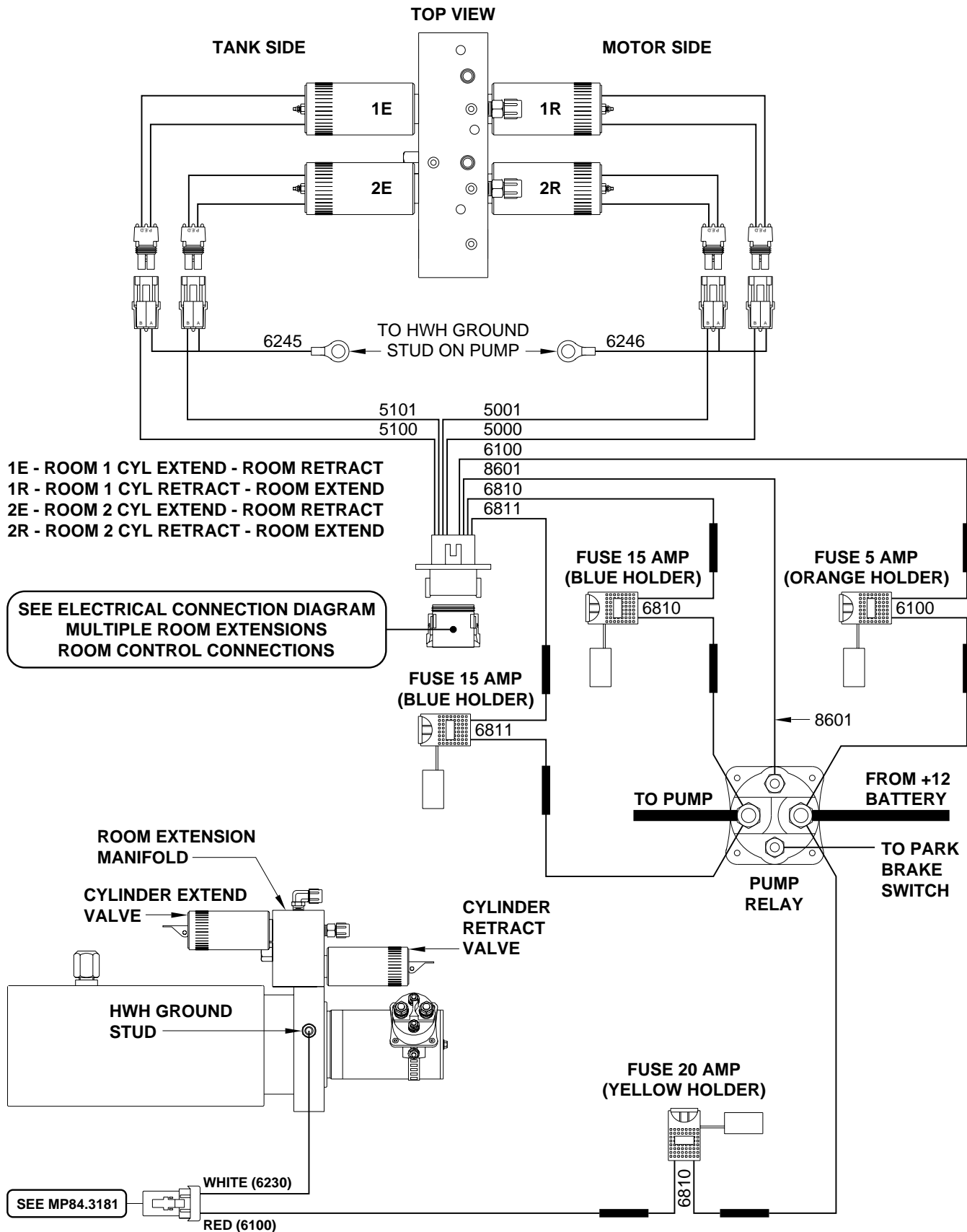

ELECTRICAL CONNECTION DIAGRAM

TWO ROOM EXTENSIONS

ROOM CONTROL CONNECTIONS

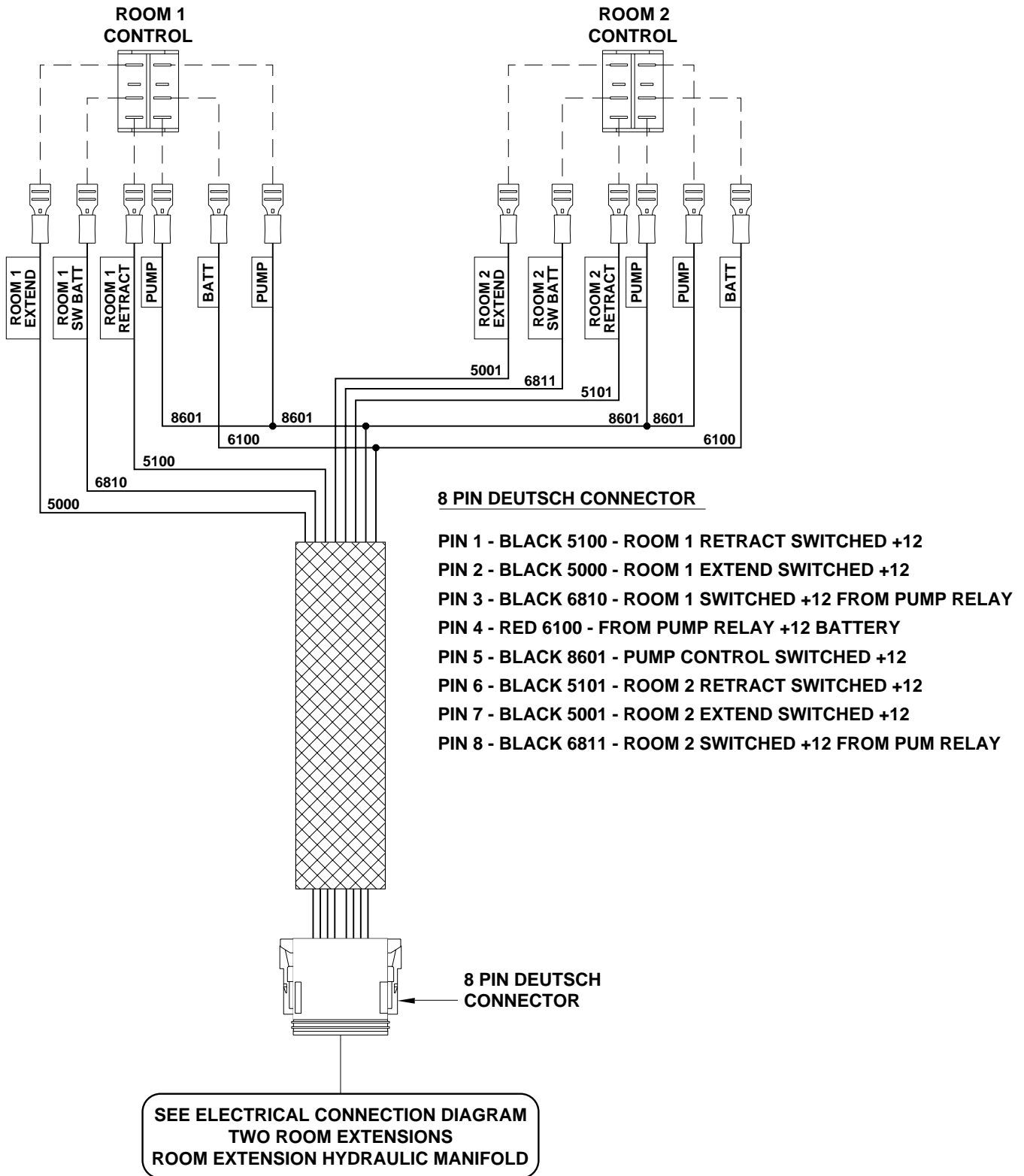

ELECTRICAL CONNECTION DIAGRAM LEVEL SENSING UNIT

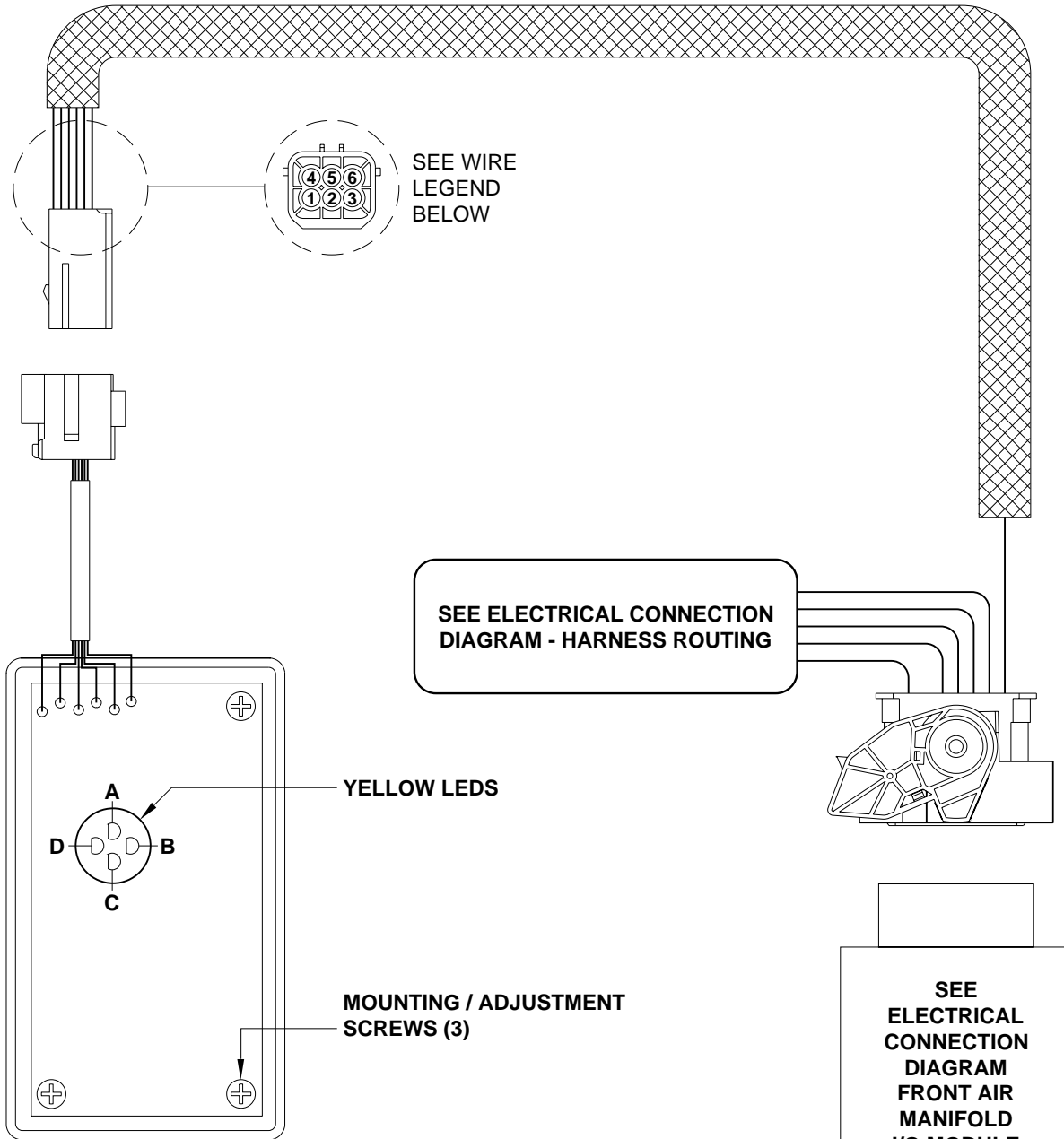

**BOTTOM VIEW OF
SENSING UNIT**

- LED A - FRONT OF VEHICLE**
- LED B - LEFT SIDE OF VEHICLE (DRIVER SIDE)**
- LED C - REAR OF VEHICLE**
- LED D - RIGHT SIDE OF VEHICLE (PASSENGER SIDE)**

WIRE LEGEND

- PIN 1 - BLACK - 0400 - SWITCHED GROUND WHEN REAR IS LOW
- PIN 2 - WHITE - 6231 - GROUND FROM SENSING UNIT
- PIN 3 - RED - 6121 - +12 VOLT FOR SENSING UNIT
- PIN 4 - BLACK - 0100 - SWITCHED GROUND WHEN LEFT SIDE IS LOW
- PIN 5 - BLACK - 0200 - SWITCHED GROUND WHEN FRONT IS LOW
- PIN 6 - BLACK - 0300 - SWITCHED GROUND WHEN RIGHT SIDE IS LOW

ELECTRICAL CONNECTION DIAGRAM COMPRESSOR DIAGRAM

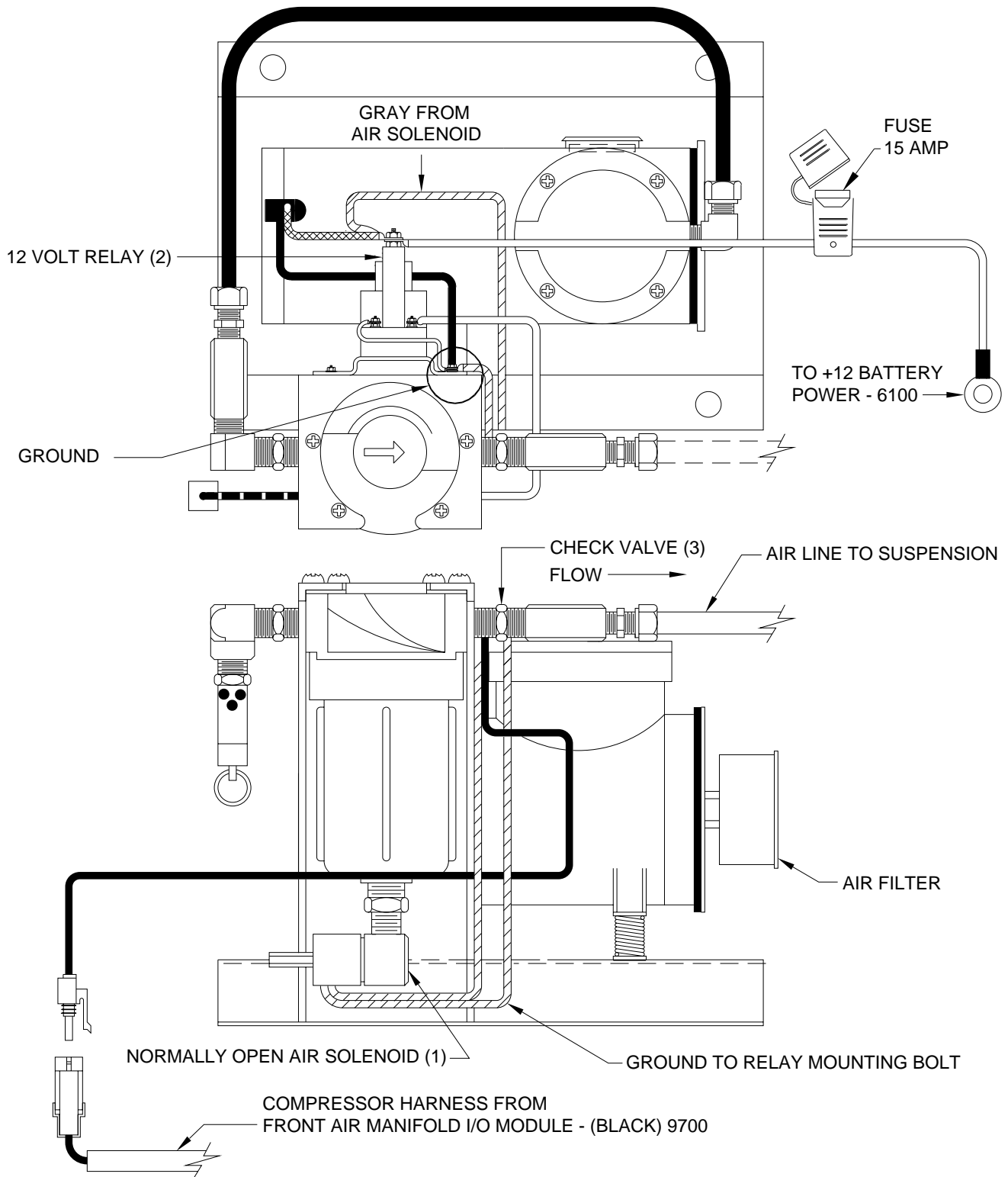

The control box sends a +12 signal to the normally open 12 volt relay. The 12 volt relay (2) will energize and the compressor will run. The normally open air solenoid (1) will close allowing the compressor to build pressure.

The normally open air solenoid (1) will open any time the compressor is not running, allowing internal pressure & moisture to bleed off. The check valve (3) will keep the suspension air from bleeding back to the compressor.

ELECTRICAL CONNECTION DIAGRAM

AIR COMPRESSOR

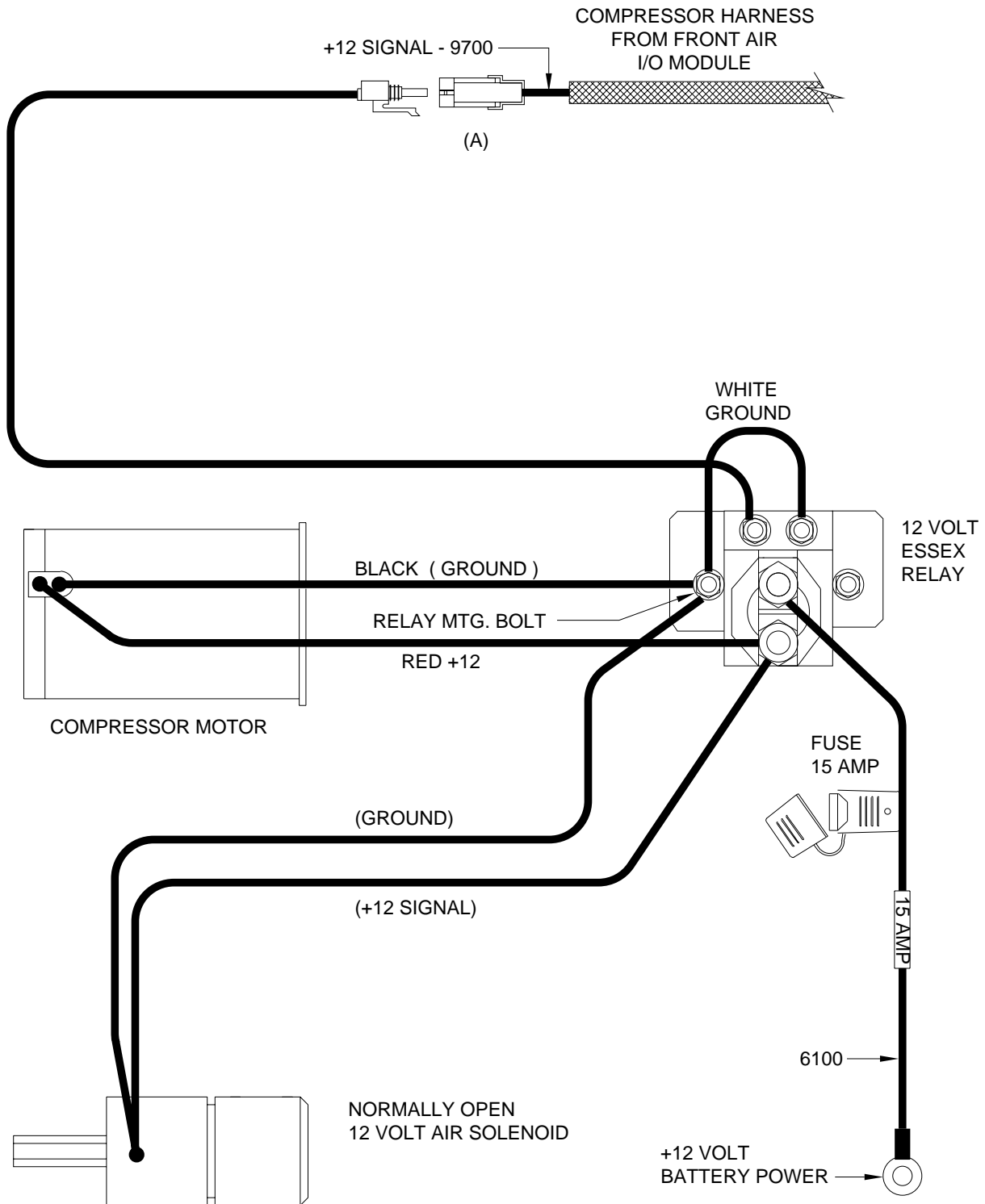

ELECTRICAL CONNECTION DIAGRAM AIR / HYDRAULIC LEVELING SYSTEM TOUCH PANEL CONNECTIONS

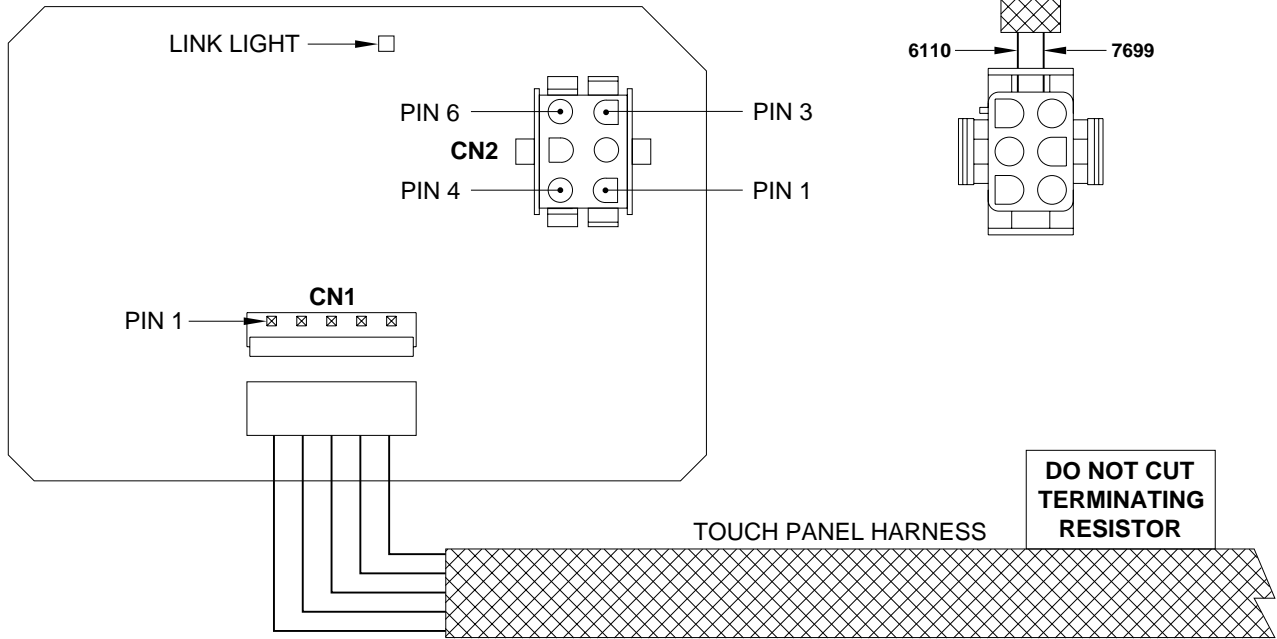
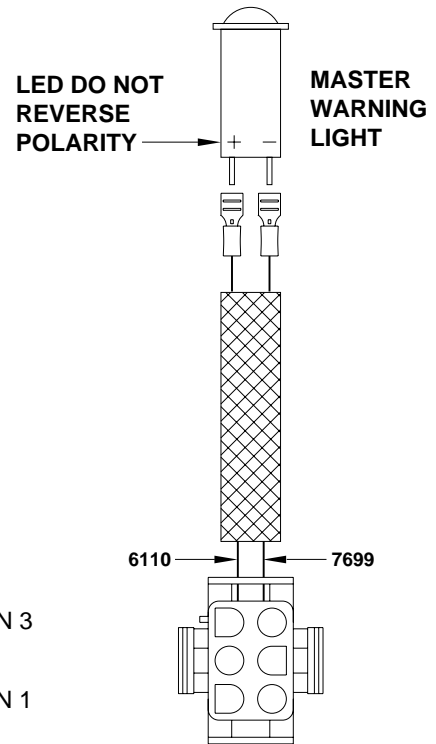
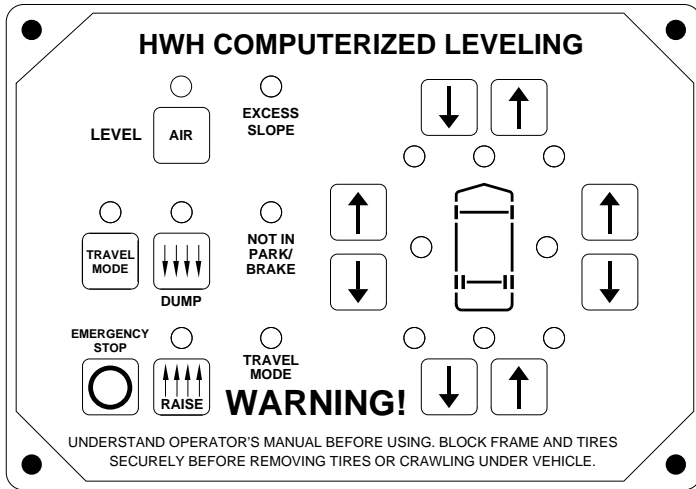

NOTE: THERE IS A 120 OHM TERMINATING RESISTOR AT EACH END OF THE TOUCH PANEL HARNESS. DO NOT REMOVE, CUT OR MODIFY THE HARNESS.

PIN #	WIRE COLOR	WIRE NUMBER	WIRE DESCRIPTION AND FUNCTION
CN1			
1	YELLOW		CAN HIGH
2	GREEN		CAN LOW
3			CAN SHIELD
4	WHITE	6230	GROUND FROM CONTROL MODULE
5	RED	6800	SWITCHED BATTERY FROM CONTROL MODULE
CN2			
1 - 3 - 4 - 6			NO CONNECTION
2	RED	6110	+12 SUPPLY
5	BLACK	7699	SWITCHED GROUND WARNING LIGHT CONTROL

INFORMATION/INSTRUCTION SHEET

HYDRAULIC SOLENOID VALVE

IDENTIFICATION - MANUAL OPERATIONS - REPLACEMENT

REPLACEMENT VALVES WILL HAVE A VALVE RELEASE CAM

BREATHER CAP W/NUT DRIVER

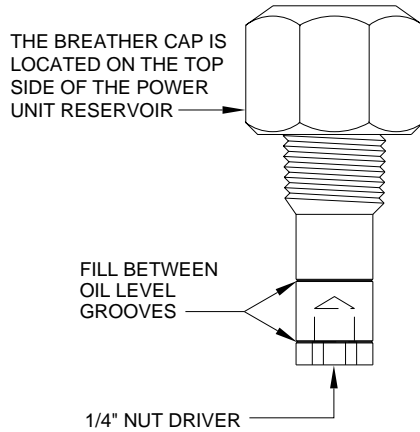

IMPORTANT: PRIOR TO REMOVING THE BREATHER CAP, EITHER TO CHECK THE OIL LEVEL OR TO USE 1/4" NUT DRIVER, CLEAN ANY DEBRIS FROM THE TOP OF THE RESERVOIR. BEFORE RETURNING THE BREATHER CAP TO THE RESERVOIR, REMOVE ANY PAINT CHIPS OR OTHER DEBRIS FROM THE DIPSTICK INCLUDING DEBRIS INSIDE THE 1/4" NUT DRIVER.

SOLENOID VALVES WITH CAM RELEASE

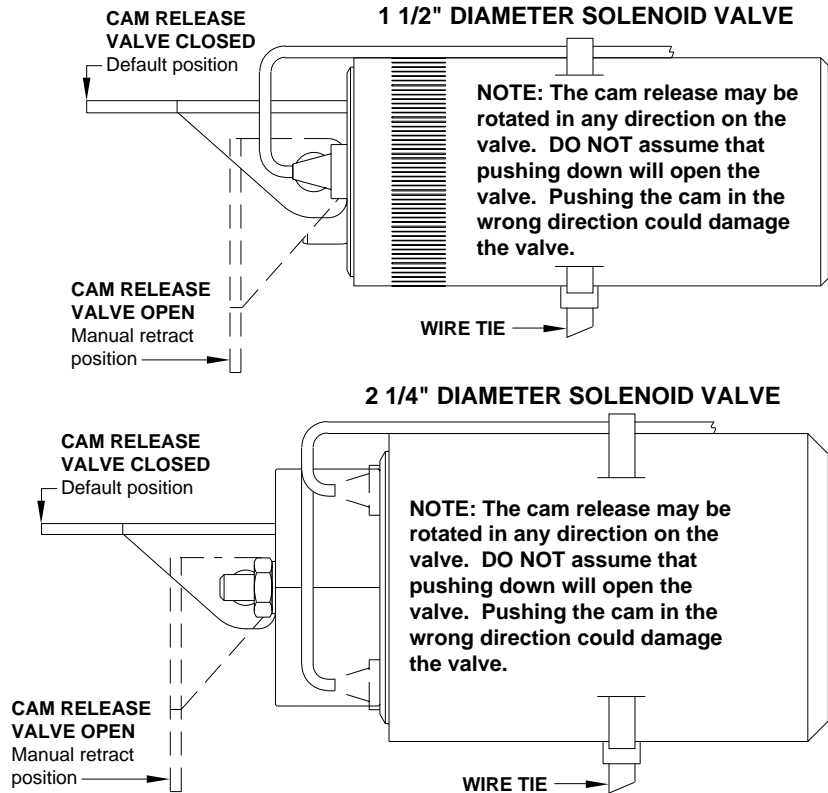

SOLENOID VALVES WITH 1/4" NUT RELEASE

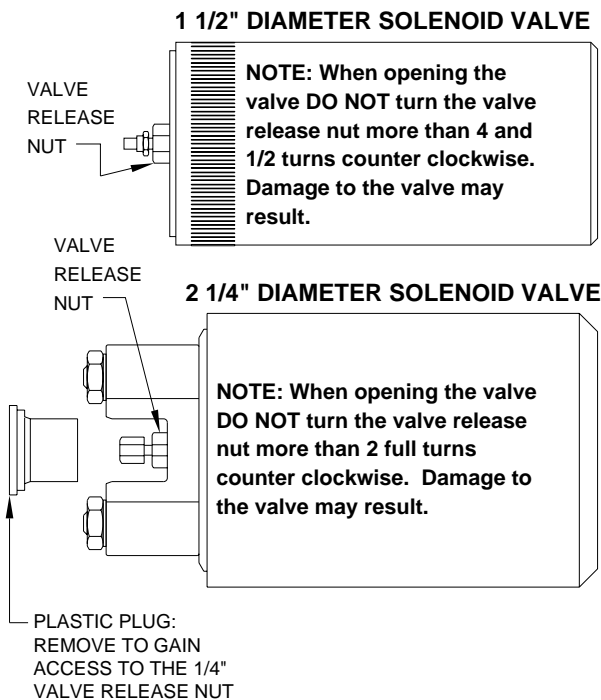

SOLENOID VALVES WITH T-HANDLE RELEASE

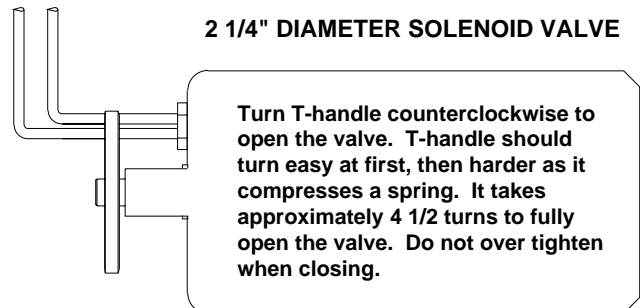

NOTE: OLD STYLE HEX SHAPED SOLENOID VALVES HAVE NO MANUAL VALVE RELEASE.