



OPERATOR'S MANUAL

HWH® COMPUTER-CONTROLLED 725 SERIES LEVELING SYSTEM

FEATURING:

- Single Touch - Touch Panel Leveling Control*
- BI-AXIS® Hydraulic Leveling*
- Four Straight-Acting, Power-Extend/Power-Retract Jacks*
- Remote Room Manifold*
- Five Universal Level Out Room Extensions*
- Auxiliary Hand Pump*

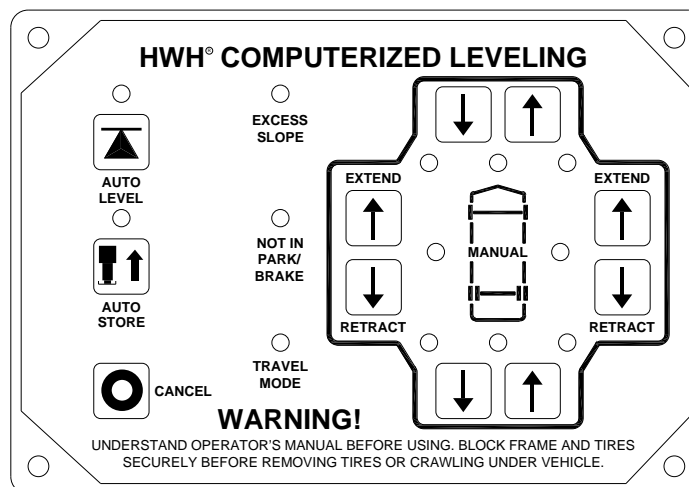

HWH CORPORATION

(On I-80, Exit 267 South)

2096 Moscow Road | Moscow, Iowa 52760

Ph: 800/321-3494 (or) 563/724-3396 | Fax: 563/724-3408

www.hwh.com

OPERATOR'S MANUAL

WARNING !

READ THE ENTIRE OPERATOR MANUAL BEFORE OPERATING.

BLOCK FRAME AND TIRES SECURELY BEFORE CRAWLING UNDER VEHICLE. DO NOT USE LEVELING JACKS OR AIR SUSPENSION TO SUPPORT VEHICLE WHILE UNDER VEHICLE OR CHANGING TIRES. VEHICLE MAY DROP AND/OR MOVE FORWARD OR BACKWARD WITHOUT WARNING CAUSING INJURY OR DEATH.

KEEP ALL PEOPLE CLEAR OF VEHICLE WHILE OPERATING LEVELING SYSTEM OR ROOM EXTENSIONS.

KEEP ALL PEOPLE CLEAR OF VEHICLE WHILE DUMPING AIR FROM THE VEHICLE'S SUSPENSION.

DO NOT MOVE THE VEHICLE IF THE VEHICLE IS NOT AT THE PROPER RIDE HEIGHT. CONTACT MANUFACTURER TECHNICAL SERVICE FOR MOVING THE VEHICLE WHEN NOT AT THE PROPER RIDE HEIGHT.

WEAR SAFETY GLASSES WHEN INSPECTING OR SERVICING THE SYSTEM TO PROTECT EYES FROM DIRT, METAL CHIPS, OIL LEAKS, ETC. FOLLOW ALL OTHER APPLICABLE SHOP SAFETY PRACTICES.

IMPORTANT: IF COACH IS EQUIPPED WITH A ROOM EXTENSION, READ ROOM EXTENSION SECTION BEFORE OPERATING LEVELING SYSTEM.

HOW TO OBTAIN WARRANTY SERVICE

THIS IS NOT TO BE INTERPRETED AS A STATEMENT OF WARRANTY

HWH CORPORATION strives to maintain the highest level of customer satisfaction. Therefore, if you discover a defect or problem, please do the following:

FIRST: Notify the dealership where you purchased the vehicle or had the leveling system installed. Dealership management people are in the best position to resolve the problem quickly. If the dealer has difficulty solving the problem, he should immediately contact the Customer Service Department, at HWH CORPORATION.

SECOND: If your dealer cannot or will not solve the problem, notify the Customer Service Department:
HWH CORPORATION 2096 Moscow Rd. Moscow IA. 52760
(563) 724-3396 OR (800) 321-3494. Give your name and address, coach manufacturer and model year, date the coach was purchased, or the date of system installation,

description of the problem, and where you can be reached during business hours (8:00 a.m. till 5:00 p.m. c.s.t.). HWH CORPORATION personnel will contact you to determine whether or not your claim is valid. If it is, HWH CORPORATION will authorize repair or replacement of the defective part, either by appointment at the factory or by the authorization of an independent service facility, to be determined by HWH CORPORATION. All warranty repairs must be performed by an independent service facility authorized by HWH CORPORATION, or at the HWH CORPORATION factory, unless prior written approval has been obtained from proper HWH CORPORATION personnel.

CONTROL IDENTIFICATION

625S / 725 / 2000 SERIES LEVELING SYSTEM

COMPUTER-CONTROL

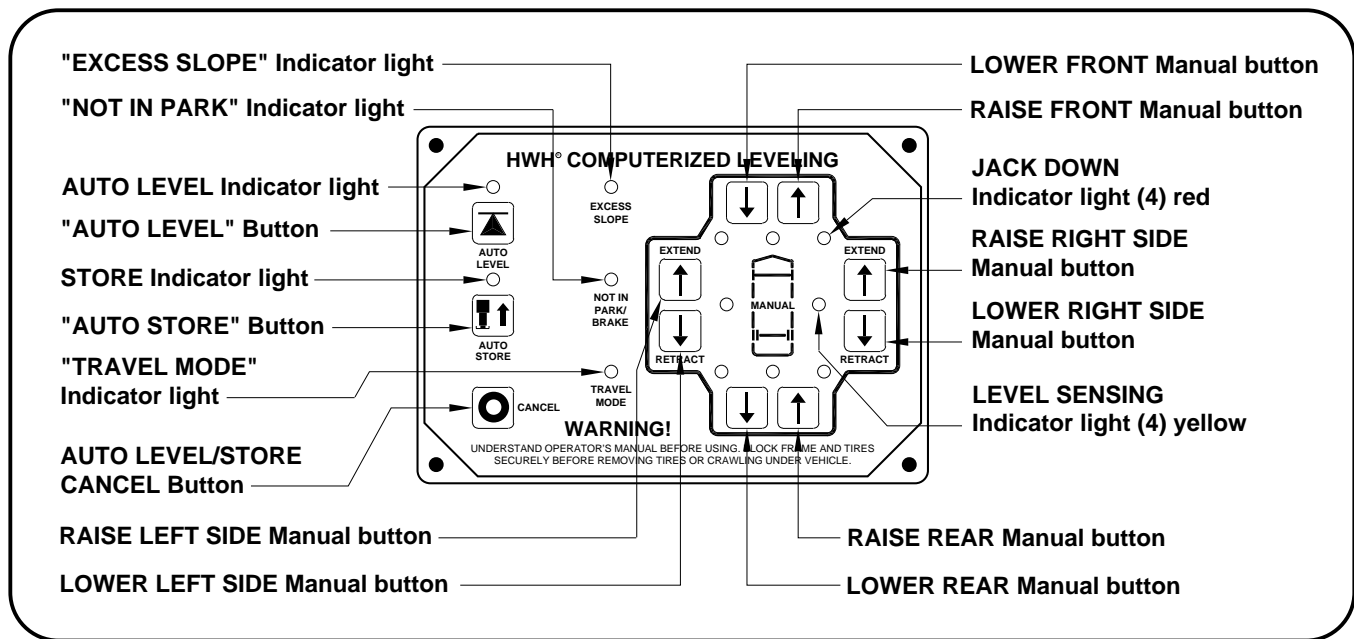

CONTROL FUNCTIONS

CONTROL BUTTONS

"CANCEL" BUTTON: Push this button to stop any leveling system operation.

"AUTO LEVEL" BUTTON: Push this button any time to start the automatic leveling function.

"AUTO STORE" BUTTON: Push this button to retract all four jacks at the same time.

EXTEND BUTTONS (UP ARROWS): These buttons will extend their respective jack pairs to lift the vehicle.

RETRACT BUTTONS (DOWN ARROWS): These buttons will retract their respective jack pairs to lower the vehicle.

INDICATOR LIGHTS

AUTO LEVEL INDICATOR LIGHT: This light will flash during the automatic leveling function.

STORE INDICATOR LIGHT: This light will flash during the automatic store function.

WARNING LIGHTS: The four red lights surrounding the yellow level indicators are jacks down WARNING lights. They are functional only when the ignition is in the "ON" or "ACC" position, the system is on, and the jacks are extended 1/4 to 1/2 inch.

INDICATOR LIGHTS (CONTINUED)

LEVELING LIGHTS: The four yellow indicating lights are level sensing indicators. When a yellow light is on, it indicates that its side, end, or corner of the vehicle is low. No more than two lights should be on at the same time. When all four yellow LEVEL lights are out, the vehicle is level.

"EXCESS SLOPE" LIGHT: This indicator will light when the leveling system cannot level the vehicle.

"NOT IN PARK/BRAKE" LIGHT: This indicator will light when the hand/auto brake is not set and the "AUTO LEVEL" button is being pushed.

"TRAVEL MODE" LIGHT: This indicator light will be on when the ignition is on, when the jacks are retracted and there are no red WARNING lights on.

MASTER "JACKS DOWN" WARNING LIGHT: This is a light mounted in the dash separate from the touch panel. It will be on when any one or more jacks are extended and the ignition is "ON".

AUDIBLE ALARM: This is a jacks down warning. It will sound if the master "JACKS DOWN" warning light is on.

CONTROL IDENTIFICATION

ROOM CONTROL SWITCH

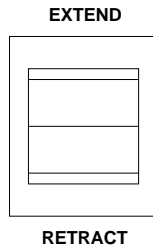

The ROOM CONTROL SWITCH is a two position momentary switch. Pressing the switch in the EXTEND POSITION will extend the room. Pressing the switch in the RETRACT POSITION will retract the room. Releasing the ROOM CONTROL SWITCH will halt the operation of the room.

CONTROL IDENTIFICATION

PUMP RUN TIME

PUMP RUN TIME

Pump motors used with HWH leveling systems and room extension systems come in 3 different diameters; 3", 3.7" and 4.5". Contact the vehicle manufacturer or HWH for help with identifying the motor size. **It is important that any time the pump runs for more than three minutes with a 3" motor; or six minutes with a 3.7" or 4.5" motor that the motor is allowed to cool for thirty minutes before continuing. Continuous operation of the pump motor without allowing the motor to cool can damage the motor.** For cold weather information see "COLD WEATHER OPERATIONS" below.

The HWH systems with a computer processor monitor the pump run time and will turn the pump off if the run time exceeds a specified time. This time can vary with different systems. Due to available electronics or system design, the pump run time programs will also vary. Leveling systems and room extensions that are not controlled by a system processor have no pump run time protection. **DO NOT run the pump more than three or six minutes without allowing the pump motor to cool for thirty minutes.**

SYSTEM VARIATIONS FOR PUMP RUN TIME

Some systems with rooms run the rooms separate from the system processor. These systems do not monitor pump run time when operating the rooms. **DO NOT run the pump more than three or six minutes without allowing the pump motor to cool for thirty minutes.**

Some systems can be turned back on immediately after the processor turns the pump off. **DO NOT turn the system back on or run the pump without allowing the pump motor to cool for thirty minutes.**

When operating some leveling systems manually or operating the room extensions, the pump will turn off and back on while pushing the control button when the pump run time has been exceeded. **DO NOT continue without allowing the pump motor to cool for thirty minutes.**

With some systems, when the processor has turned the pump off because the run time has been exceeded, power to the HWH system must be turned off and back on before the system will operate. With motorized vehicles, turn the ignition off and back on. With non-motorized vehicles, turn the master power switch for the HWH system off and back on. **DO NOT continue without allowing the pump motor to cool for thirty minutes.**

Some HWH systems are equipped with a lighted reset switch. If the processor turns the pump off because the run time has been exceeded, the light in the reset switch will turn on. The system will not operate until the reset switch is pushed.

DO NOT continue without allowing the pump motor to cool for thirty minutes.

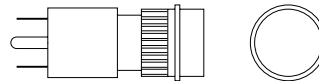

LIGHTED RESET SWITCH

No matter what HWH system is on the vehicle, the pump should not be ran for more than three minutes (3" motors) or six minutes (3.7" or 4.5" motors) without allowing the pump motor to cool for thirty minutes. Continuous operation of the pump motor without allowing the motor to cool can damage the pump motor.

Contact HWH corporation to get specific information about the system in this vehicle.

COLD WEATHER OPERATIONS

HWH leveling and room extension systems are designed to function in cold weather down to 0 degrees Fahrenheit. Below freezing (32 degrees Fahrenheit) the jacks or rooms will operate slower than usual.

For operation in temperatures dropping below -20 degrees Fahrenheit, it is necessary that the system is equipped with oil designed for extreme cold weather application such as a synthetic oil. (Contact HWH for recommendations.)

DO NOT run the pump motor continuously. It is important that any time the pump runs for more than three minutes with a 3" motor; or six minutes with a 3.7" or 4.5" motor that the motor is allowed to cool for thirty minutes before continuing. Continuous operation of the pump motor without allowing the motor to cool can damage the motor. Continuous operation of the pump with slow moving jacks or rooms in cold weather, without allowing the pump motor to cool will cause the pump motor to burn up and damage the pump assembly.

OPERATING PROCEDURES

GENERAL INSTRUCTIONS

Maintain adequate clearance in all directions for vehicle, room extensions, awnings, doors, steps, etc. Vehicle may move in any direction due to jacks extending or retracting, settling of the jacks or the vehicle, equipment malfunction, etc..

NOTE: This manual is intended for vehicles with a spring or air suspension. If the vehicle has an air suspension with a manual pilot air dump, refer to the vehicle manufacturer for operating instructions.

If parking on soft ground or asphalt paving, a wood block or pad should be placed under each jack.

Press the "CANCEL" button or turn the ignition switch "OFF" at any time to stop the operation of the system.

Any time a hydraulic leveling process is interrupted, retract the jacks according to the JACK RETRACTION Section and then restart the leveling process.

If the hand / auto brake is not set when the "AUTO LEVEL" button is pressed, the "NOT IN PARK/BRAKE" light will come on. When the "AUTO LEVEL" button is released the "NOT IN PARK/BRAKE" light will go out. The Automatic Leveling function will not start.

WARNING: DO NOT MOVE THE VEHICLE IF ONE OR MORE JACKS ARE EXTENDED TO THE GROUND.

PREPARATION FOR TRAVEL

IMPORTANT: Before traveling, the red jack warning lights must be off, the "TRAVEL MODE" light must be on and the vehicle should be at the proper height for travel. If lights are not correct for travel, retract jack as described in the JACK RETRACTION Section.

If the jacks are retracted but a red "WARNING" light is lit the system needs to be serviced.

Any room extension, step or generator slide should be fully retracted before traveling.

WARNING: DO NOT MOVE THE VEHICLE WHILE THE LEVELING JACKS ARE STILL IN CONTACT WITH THE GROUND OR IN THE EXTEND POSITION. THIS VEHICLE IS EQUIPPED WITH STRAIGHT-ACTING JACKS. MOVING THE VEHICLE WITH THE LEVELING JACKS EXTENDED CAN CAUSE SEVERE DAMAGE TO THE JACKS AND OR THE VEHICLE AND CREATE A DRIVING

HAZARD. DO NOT RELY SOLELY UPON WARNING LIGHTS. IT IS THE OPERATOR'S RESPONSIBILITY TO CHECK THAT ALL JACKS ARE FULLY RETRACTED INTO THE STORE/TRAVEL POSITION AND THE VEHICLE IS AT THE PROPER RIDE HEIGHT FOR TRAVELING. CONTACT MANUFACTURER TECHNICAL SERVICE BEFORE MOVING A VEHICLE THAT IS NOT AT PROPER TRAVEL HEIGHT.

If the jacks cannot be retracted according to the JACK RETRACTION Section, retract the jacks according to the MANUAL JACK RETRACTION Section. The system should then be checked.

NOTE: If the vehicle is parked or stored with the jacks extended for an extended period of time and the jacks fail to retract completely, extend the jacks back down to the ground then retract the jacks again.

ROOM EXTENSION PROCEDURES

IMPORTANT: If the vehicle is equipped with a room extension read this section carefully.

If the vehicle is equipped with kick-down jacks, the wheels MUST be blocked securely. It is recommended to complete the Leveling Procedure before operating room extensions. It is recommended to retract room extensions before retracting jacks.

Refer to the vehicle owners manual for proper operation of room extensions.

IMPORTANT: Do not use a room extension support when the vehicle is supported by the leveling system.

OPERATING PROCEDURES

725/2000 SERIES LEVELING SYSTEM

AUTOMATIC HYDRAULIC LEVELING

1. Place transmission in the recommended position for parking the vehicle and set parking brake. Turn the coach engine off. Turn the ignition to the "ACCESSORY" position.
2. At this time, the operator may want to check the jacks and place a pad under each jack if the ground will not support the vehicle.

WARNING: PRIOR TO PUSHING THE "AUTO LEVEL" BUTTON THE OPERATOR MUST BE SURE THAT ALL PERSONS AND OBJECTS ARE CLEAR OF THE VEHICLE.

NOTE: If the vehicle is equipped with an air suspension and a manual suspension dump, the suspension air should be exhausted at this time. Refer to the vehicle manufacturer for operating instructions.

3. Press the "AUTO LEVEL" button one time. The AUTO LEVEL light will start to flash, the leveling process will begin.

IMPORTANT: During the Automatic Leveling procedures, pushing the "AUTO LEVEL", "AUTO STORE" or the "CANCEL" button on the HWH touch panel will stop the automatic leveling function.

AUTO LEVEL SEQUENCE: During the automatic leveling sequence, after the system has extended the appropriate jacks to level the vehicle and has turned the yellow level indicator lights off, the system will then stabilize the vehicle. While the system is stabilizing the vehicle, the yellow level indicator lights are inhibited from coming on. Stabilizing the vehicle is accomplished by extending any jacks to the ground that were not used to level the vehicle. This is done by monitoring a pressure switch on each jack. Any jack used to stabilize the vehicle will lift the vehicle approximately one-half (1/2) inch. This "bumps" the vehicle up slightly when stabilizing. Due to the 1/2 degree accuracy tolerance of the sensing unit, one or two yellow level indicator lights may come on after the red auto level indicator light turns off. The slight lift experienced during the stabilizing procedure normally is not sufficient to cause a level issue for the motor home. However, a feature of the single step leveling system is the manual leveling buttons will function anytime the ignition is in the ON or ACC. position and the park brake is set. If desired, the operator can use the UP ARROWS (extend jacks) that correspond to any lit yellow level indicator light to "bump" the vehicle up slightly to turn that yellow indicator light off.

EXCESS SLOPE SITUATION: In the event the jacks are unable to level the coach, the "EXCESS SLOPE" light will come on. Excess slope is one or two jacks fully extending without turning the yellow level light out. The system will not stabilize the vehicle if the "EXCESS SLOPE" light comes on. One or more jacks may not be extended. The system will shut off leaving the "EXCESS SLOPE" light on. The "EXCESS SLOPE" light will remain on if the ignition is in the "ON" or "ACC" position, until the jacks have been fully retracted turning the red warning lights out. Push the "STORE" button to retract the jacks. Move the vehicle to a more level position or level the vehicle as close as possible according to the MANUAL HYDRAULIC OPERATION section.

5. Turn the ignition switch to the "OFF" position.

OPERATING PROCEDURES

725/2000 SERIES LEVELING SYSTEM

JACK RETRACTION

WARNING: THE OPERATOR MUST BE SURE THAT THERE ARE NO OBJECTS UNDER THE VEHICLE AND THAT ALL PEOPLE ARE CLEAR OF THE VEHICLE.

1. Start the engine. Store the jacks immediately.

NOTE: If the vehicle is equipped with an air suspension and a manual air dump, place the suspension in the TRAVEL position at this time. Refer to the vehicle manufacturer for operating instructions.

2. Press the "STORE" button. The store indicator light will flash. As each jack retracts, its red WARNING light will go out. The pump will run with all retract loads staying on until 10 seconds after the last red warning light goes out. If any warning light remains on the pump and all retract loads will remain on for (6) minutes from the time the "AUTO STORE" button was pushed.

IMPORTANT: DO NOT interrupt power to the leveling system while the "STORE" indicator light is blinking. DO NOT push the "OFF" button or turn the ignition key. The system must be allowed to completely finish the STORE mode.

WARNING: DO NOT MOVE THE VEHICLE WHILE THE LEVELING JACKS ARE STILL IN CONTACT WITH THE GROUND OR IN THE EXTEND POSITION. THIS VEHICLE IS EQUIPPED WITH STRAIGHT-ACTING JACKS. MOVING THE VEHICLE WITH THE LEVELING JACKS EXTENDED CAN CAUSE SEVERE DAMAGE TO THE JACKS AND OR THE VEHICLE AND CREATE A DRIVING HAZARD. DO NOT RELY SOLELY UPON WARNING LIGHTS. IT IS THE OPERATOR'S RESPONSIBILITY TO CHECK THAT ALL JACKS ARE FULLY RETRACTED INTO THE STORE/TRAVEL POSITION AND THE VEHICLE IS AT THE PROPER RIDE HEIGHT.

3. The vehicle can be moved as soon as the red warning lights are out, the jacks are in the STORE/TRAVEL position, the green "TRAVEL" light is on, and the suspension air bags are inflated to the vehicles proper ride height.

IMPORTANT: If a red warning light and buzzer come on while traveling, the jacks should be checked as soon as a safe parking location is found.

4. If jacks cannot be retracted by the above procedure see MANUAL JACK RETRACTION Section.

OPERATING PROCEDURES

MANUAL HYDRAULIC OPERATION

1. Place transmission in the recommended position for parking the vehicle, and set the parking brake. Turn the ignition to the "ACCESSORY" position.

NOTE: if the vehicle is equipped with a manual suspension air dump, the air must be exhausted from the suspension before leveling. Refer to the vehicle manufacturer for instructions.

2. Place pads under the jack feet if the ground will not support the vehicle on the jacks.

3. The vehicle may be leveled using the manual EXTEND (UP ARROW) buttons on the right half of the panel. If a yellow LEVEL SENSING light is on, that side or end of the vehicle is low. It is best to level the vehicle side to side first, if needed, before front to rear.

Jacks will extend (or retract) in pairs to raise (or lower) a side or end of the vehicle. Any jack not used for leveling can be extended to the ground. This provides additional stability against wind and activity in the vehicle. Jacks used to stabilize the vehicle after leveling is complete should lift the vehicle slightly after touching the ground.

IMPORTANT: Do not continue to push an EXTEND button for more than ten (10) seconds after that pair of jacks are fully extended.

4. When leveling is completed, turn the ignition switch to the "OFF" position.

IMPORTANT: Push the "STORE" button before traveling when manual operation of the leveling system is used.

OPERATING PROCEDURES

MANUAL JACK RETRACTION

MANUAL JACK RETRACTION

WARNING: KEEP AWAY FROM THE WHEELS, DO NOT CRAWL UNDER THE VEHICLE, KEEP A SAFE DISTANCE IN FRONT AND REAR OF THE VEHICLE. THE VEHICLE MAY DROP AND/OR MOVE FORWARD OR BACKWARD WITHOUT WARNING AS THE VALVE RELEASE IS OPERATED.

IMPORTANT: HWH recommends that all HWH room extensions are fully retracted prior to performing manual jack retraction procedures.

Use the manual valve release for retracting the jacks only if the STORE feature on the HWH control panel will not retract the jacks.

1. Locate your power unit-manifold assembly. The diagram below represents a typical Power Unit-Manifold Assembly it may not be an exact match to yours. Some assemblies may have a separate manifold for two of the jacks. Check the stickers on top of the manifold to locate the proper valves for the jacks.

2. Allow clearance for the vehicle to lower.

3. Retract the two front jacks by slowly moving the release cams for the two front retract (RET) valves to the "VALVE OPENED" position.

4. After the front jacks have retracted for several seconds, repeat the process for the rear jacks by opening the two rear retract (RET) valves.

NOTE: If the vehicle is equipped with power-extend/power-retract (double-acting) jacks, refer to "AUXILIARY HAND PUMP OPERATION" page to retract the jacks completely.

5. Check that all jacks are now retracted. If yes, continue. If no, notify the dealership where you purchased the vehicle or had the leveling system installed or contact HWH Corporation customer service.

IMPORTANT: RELEASE CAM MIGHT BE ROTATED TO ANY DIRECTION ON THE VALVE. MAKE SURE TO MOVE THE RELEASE CAMS IN THE CORRECT DIRECTION. INCORRECT MOVEMENT OF THE CAMS CAN DAMAGE THE VALVES.

6. Close all valves by moving the release cams to the "VALVE CLOSED" position.

7. The system should be serviced before using again.

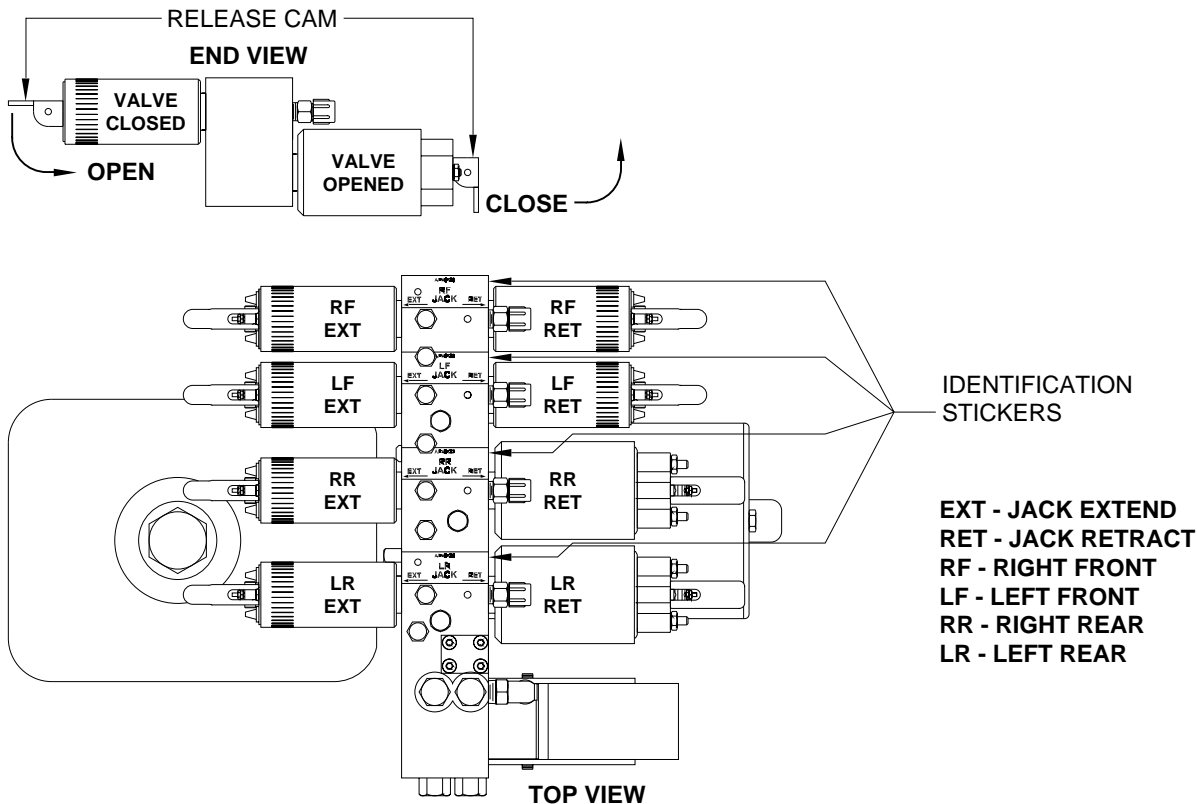

OPERATING PROCEDURES

ROOM EXTEND PROCEDURE

WARNING: OPERATING A ROOM WITH ANY ROOM LOCKING, CLAMPING OR MANUAL RETRACTING DEVICES ATTACHED OR ENGAGED CAN CAUSE PERSONAL INJURY AND VEHICLE DAMAGE. IT IS THE OPERATOR'S RESPONSIBILITY TO ENSURE THAT ALL ROOM LOCKING, CLAMPING OR MANUAL RETRACTING DEVICES ARE DETACHED OR DISENGAGED BEFORE OPERATING THE ROOM.

Refer to vehicle manufacturer for proper sequence of room extension and leveling system operation.

1. Unlock all room-locking devices to include travel clamps/locks supplied by manufacturers other than HWH.

NOTE: If a **MANUAL RETRACT WINCH** is attached to the room remove it before extending the room.

WARNING: KEEP PEOPLE AND OBSTRUCTIONS CLEAR OF ROOM WHEN OPERATING.

NOTE: Make sure there is adequate clearance to fully extend the room.

NOTE: The park brake must be set to operate the rooms.

2. If applicable, turn the vehicle ignition to the ACC position.

3. If the vehicle is equipped with HWH room control panels, turn the panel key switch to ON.

4. To extend the room, press and hold the ROOM CONTROL SWITCH in the "EXTEND" position until the room is fully extended.

IMPORTANT: If the room extension is a level out room, hold the room control switch to the extend position until the room is fully extended and has dropped to the completely lowered position.

NOTE: Hold the switch to "EXTEND" three or four seconds after the room is fully extended. This assures proper pressurization of the cylinders. **During normal operation of the room, do not reverse direction of the room until the room is fully extended. If necessary, the direction of the room may be reversed, but watch for binding of the room. If the direction of the room has been reversed, DO NOT re-extend the room until the room has been fully retracted.**

IMPORTANT: Do not hold the ROOM CONTROL SWITCH in the "EXTEND" position for more than ten seconds after the room is fully extended (and down if applicable) or stops moving. **If either side of the room stops moving, release the room control switch immediately. DO NOT force the room. DO NOT reverse direction of the room, contact HWH Customer Service for assistance 1-800-321-3494.**

NOTE: Releasing the ROOM CONTROL SWITCH will halt the operation of the room.

5. If applicable, turn the room control panel key switch off.

IMPORTANT: Do not use a room extension support when the vehicle is supported by the leveling system.

OPERATING PROCEDURES

ROOM RETRACT PROCEDURE

WARNING: KEEP PEOPLE AND OBSTRUCTIONS CLEAR OF ROOM WHEN OPERATING.

Refer to vehicle manufacturer for proper sequence of room extension and leveling system operation.

1. The park brake must be set. The room will not operate if the park brake is not set.
2. If applicable, turn the vehicle ignition to the ACC position.
3. If the vehicle is equipped with HWH room control panels, turn the panel key switch to ON.
4. To retract the room press and hold the ROOM CONTROL SWITCH in the "RETRACT" position until the room is fully retracted.

Important: if the room extension is a level-out room, the room must raise completely before it will retract. If the room will not raise, do not force the room. Refere to the MANUAL ROOM LIFT PROCEDURES page.

NOTE: Hold the switch to "RETRACT" three or four seconds after the room is fully retracted. This assures proper pressurization of the cylinders. **During normal operation of the room, do not reverse direction of the room until the room is fully retracted. If necessary, the direction of the room may be reversed, but watch for binding of the room. If the direction of the room has been reversed, DO NOT retract the room until the room has been fully extended.**

IMPORTANT: Do not hold the ROOM CONTROL SWITCH in the "RETRACT" position for more than ten seconds after the room is fully retracted or stops moving. **If either side of the room stops moving, release the room control switch immediately. DO NOT force the room. DO NOT reverse direction of the room, contact HWH Customer Service for assistance 1-800-321-3494.**

NOTE: Releasing the ROOM CONTROL SWITCH will halt the operation of the room.

5. If applicable, turn the room control panel key switch off.
6. If the room will not retract see the MANUAL ROOM RETRACT PROCEDURE.

IMPORTANT: Room-locking devices should be locked while traveling.

OPERATING PROCEDURES

"UNIVERSAL LEVEL OUT" ROOM EXTENSION MECHANISM

MANUAL ROOM LIFT PROCEDURES

NOTE: Manual room lift procedures must be done before manual room retraction procedures.

IMPORTANT: RELEASE CAM MIGHT BE ROTATED TO ANY DIRECTION ON THE VALVE. MAKE SURE TO MOVE THE RELEASE CAMS IN THE CORRECT DIRECTION. INCORRECT MOVEMENT OF THE CAMS CAN DAMAGE THE VALVES.

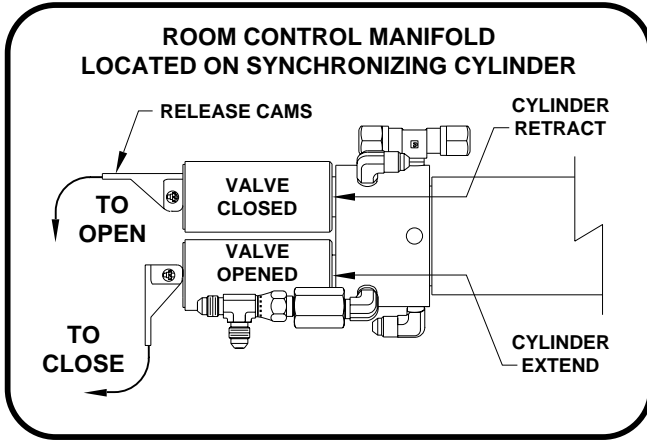

1. Determine which synchronizing cylinder controls the room. Manually open the valve release cams for the extend and retract solenoid valves by moving the cams to the "VALVE OPENED" position as shown.

2. Start both room lift bolts until resistance is met, one for the front and one for the rear mechanism should be provided.

NOTE: To locate the room lift access holes and bolts refer to vehicle manufacturer.

3. **Do Not use an impact wrench.** Using a 9/16 wrench alternate between lift bolts turning each 4 full turns each time. Lift the room only as far as is needed to clear the bottom surface of the room over the lift ramps. **As the room is lifted a gap should develop allowing you to view the lift ramps more clearly.**

4. Follow MANUAL ROOM RETRACT PROCEDURES.

IMPORTANT: If at any stage something is not understood or if the room begins to bind DO NOT force the room, contact HWH Customer Service for assistance 1-800-321-3494.

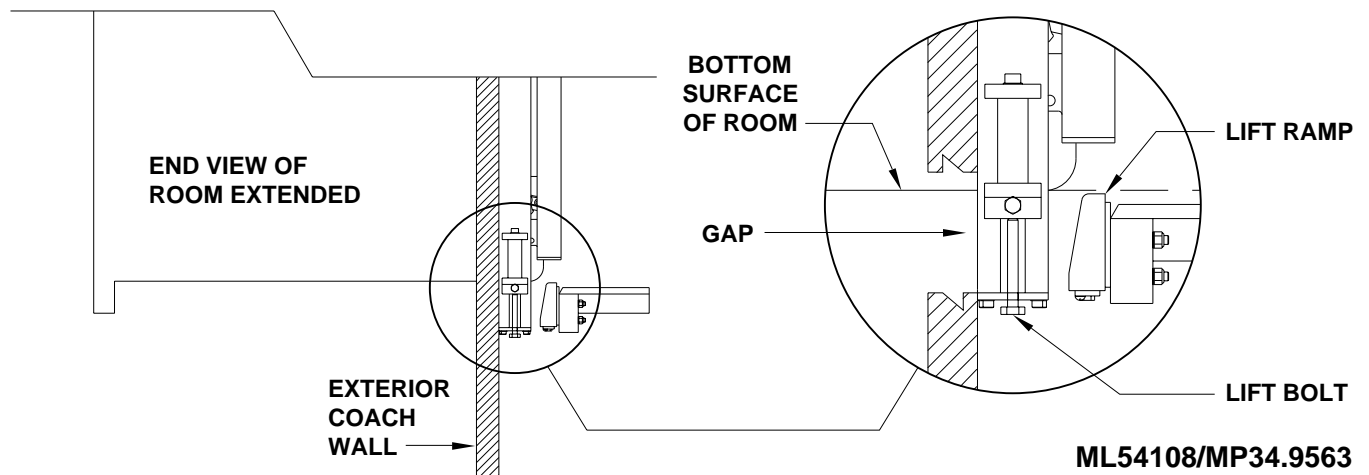
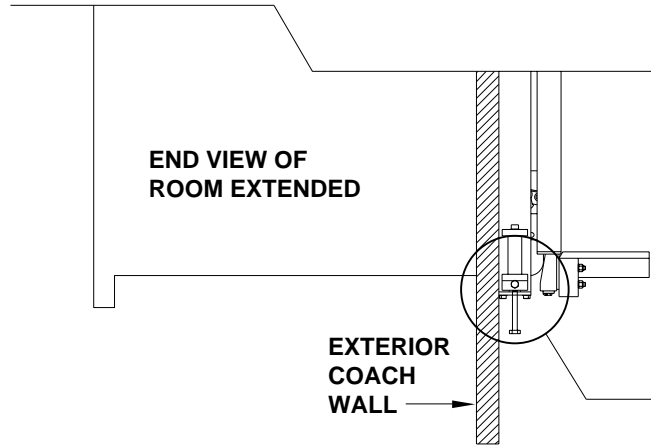

OPERATING PROCEDURES

"UNIVERSAL LEVEL OUT" ROOM EXTENSION MECHANISM

MANUAL ROOM RETRACT PROCEDURES

NOTE: Manual room lift procedures must be done before manual room retraction procedures.

1. Start both threaded rods until resistance is met, one for the front and one for the rear mechanism should be provided.

NOTE: To access the threaded blocks refer to vehicle manufacturer.

2. **Do Not use an impact wrench.** Using wrench provided, a personal wrench or a tire iron with a 1-1/8" opening rotate either mechanism's threaded rod clockwise 6 complete turns.

3. Move to the other room extension mechanism, rotate the threaded rod clockwise 12 complete turns.

4. Return to the first room extension mechanism and rotate the threaded rod clockwise 12 complete turns.

5. Repeat steps 3 and 4 alternating from mechanism to mechanism rotating each threaded rod 12 complete turns until room is sealed. (DO NOT exceed 15 ft.lbs) Make sure the room does not bind.

IMPORTANT: If at any stage something is not understood or if the room begins to bind DO NOT force the room, contact HWH Customer Service for assistance 1-800-321-3494.

NOTE: Leave the solenoid valves open, the lift bolts and threaded rods in place until the room has been serviced.

IMPORTANT: DO NOT EXTEND THE ROOM UNTIL THE ROOM HAS BEEN SERVICED. ANY SOLENOID VALVES LEFT OPEN SHOULD BE CLOSED, LIFT BOLTS AND THREADED RODS SHOULD BE COMPLETELY REMOVED.

NOTE: If there is not enough room to remove both threaded rods completely, alternate backing the threaded rods out and slightly extending the room. Be careful to not extend the room so far that the threaded rods impact the coach wall or the mechanism.

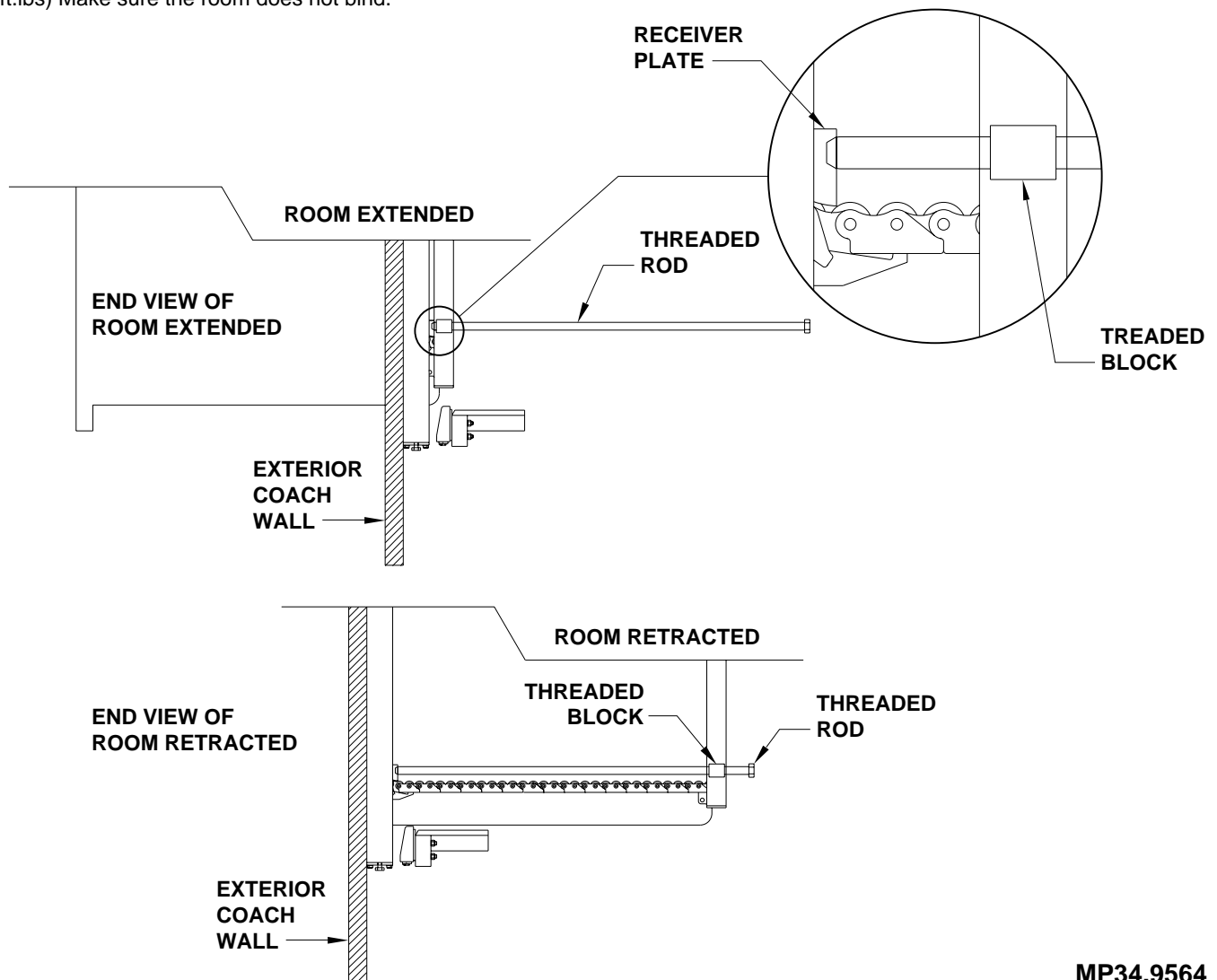

OPERATING PROCEDURES

"UNIVERSAL STRAIGHT OUT" ROOM EXTENSION MECHANISM

MANUAL ROOM RETRACTION PROCEDURES - VALVES WITH RELEASE CAMS

1. Determine which synchronizing cylinder controls the room. Manually open the valve release cams for the extend and retract solenoid valves by moving the valve release cam to the open position.

NOTE: The valve release cam might be rotated in any direction on the valve. Pushing the release cam in the wrong direction could damage the valve.

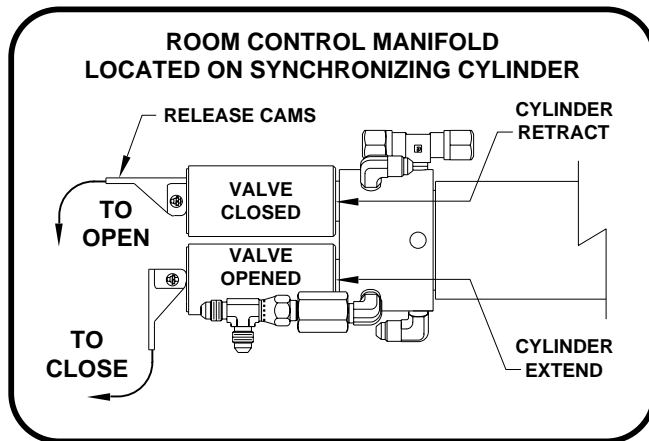

2. Start both threaded rods until resistance is met, one for the front and one for the rear mechanism should be provided.

NOTE: To access the threaded blocks refer to vehicle manufacturer.

3. **Do Not use an impact wrench.** Using wrench provided, a personal wrench or a tire iron with a 1-1/8" opening rotate either mechanism's threaded rod clockwise 6 complete turns.

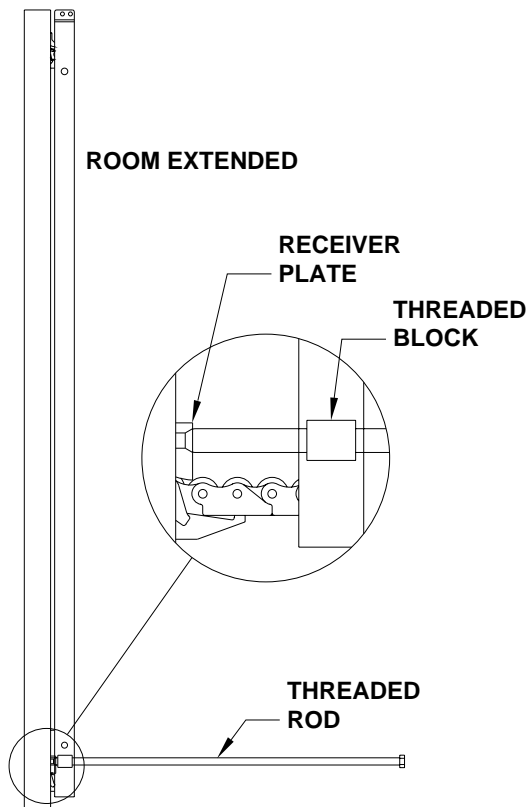

4. Move to the other room extension mechanism, rotate the threaded rod clockwise 12 complete turns.

5. Return to the first room extension mechanism and rotate the threaded rod clockwise 12 complete turns.

6. Repeat steps 4 and 5 alternating from mechanism to mechanism rotating each threaded rod 12 complete turns until room is sealed. (DO NOT exceed 15 ft.lbs) Make sure the room does not bind.

IMPORTANT: If at any stage something is not understood or if the room begins to bind DO NOT force the room, contact HWH Customer Service for assistance 1-800-321-3494.

NOTE: Leave the solenoid valves open and the threaded rods in place until the room has been serviced.

IMPORTANT: DO NOT EXTEND THE ROOM UNTIL THE ROOM HAS BEEN SERVICED. ANY SOLENOID VALVES LEFT OPEN SHOULD BE CLOSED AND THE THREADED RODS SHOULD BE COMPLETELY REMOVED.

NOTE: If there is not enough room to remove both threaded rods completely, alternate backing the threaded rods out and slightly extending the room. Be careful to not extend the room so far that the threaded rods impact the coach wall or the mechanism.

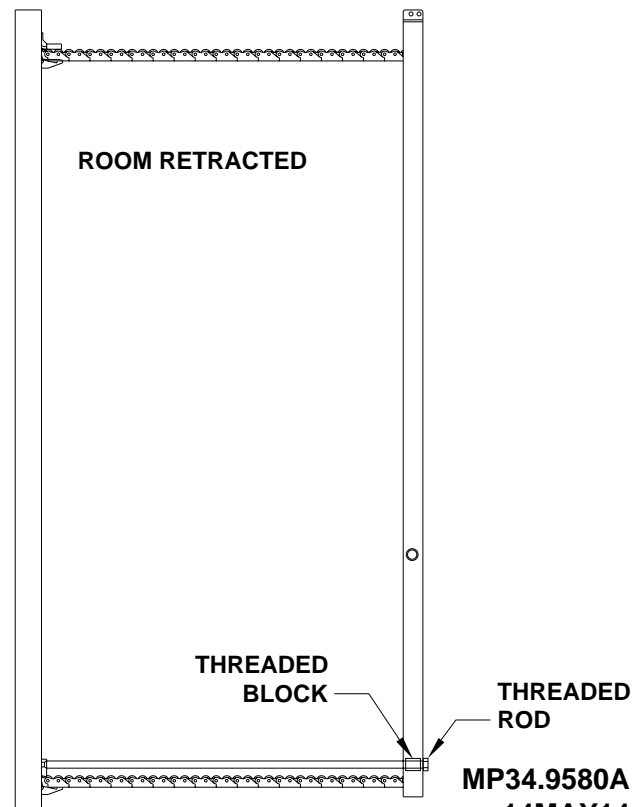

OPERATING PROCEDURES

AUXILIARY PUMP RUN SWITCH OPERATION

WARNING: KEEP AWAY FROM WHEELS, DO NOT CRAWL UNDER THE VEHICLE, KEEP A SAFE DISTANCE IN FRONT AND REAR OF THE VEHICLE. THE VEHICLE MAY DROP AND / OR MOVE FORWARD OR BACKWARD WITHOUT WARNING AS THE VALVE RELEASE IS OPERATED.

EXTEND JACKS OR ROOMS

NOTE: It is best if jacks are extended in pairs; both front, both rear, right front & right rear or left front & left rear. Only try to extend one room or step mechanism at a time.

1. Use the hydraulic connection diagrams to locate the appropriate valve(s) to extend the desired jack(s), room or step.
2. Locate the pump run switch on the power unit assembly.
3. Move the valve release cam(s) to the "VALVE OPEN" position.
4. Push the pump run toggle switch to the "RUN" position. Hold the toggle switch to "RUN" until the equipment is in the desired position.
5. Move the valve release cam(s) to the "VALVE CLOSED" position and release the the pump run toggle switch.

NOTE: If the pump toggle switch is released before closing a valve when extending a jack, the vehicle will drop until the valve is closed.

IMPORTANT: RELEASE CAM MIGHT BE ROTATED TO ANY DIRECTION ON THE VALVE. MAKE SURE TO MOVE THE RELEASE CAMS IN THE CORRECT DIRECTION. INCORRECT MOVEMENT OF THE CAMS CAN DAMAGE THE VALVES.

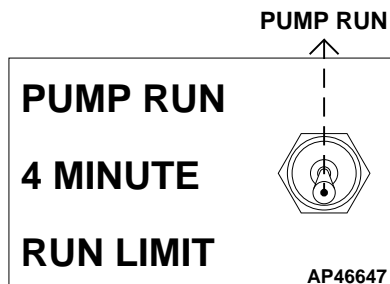

IMPORTANT: DO NOT hold the pump toggle switch to "PUMP RUN" for more than 4 minutes without allowing the pump motor to cool.

RETRACTING POWER - EXTEND / POWER - RETRACT JACKS ROOMS OR STEPS

IMPORTANT: POWER - EXTEND / SPRING - RETRACT JACKS (SINGLE ACTING CYLINDERS) CAN NOT BE RETRACTED WHEN THE PUMP IS RUNNING.

WARNING: DO NOT CRAWL UNDER THE VEHICLE TO OPEN JACK MANIFOLD VALVES. ALLOW AMPLE ROOM FOR THE VEHICLE TO MOVE IN ANY DIRECTION WHEN A JACK MANIFOLD VALVE IS OPENED. OPEN THE VALVE RELEASE CAMS SLOWLY TO KEEP THE VEHICLE FROM DROPPING RAPIDLY.

1. Use the hydraulic connection diagrams to locate the appropriate valve(s) to retract the desired jack(s), room or step.
2. Locate the pump run switch on the power unit assembly.
3. Move the valve release cam(s) to the "VALVE OPEN" position.

IMPORTANT: WHEN RETRACTING JACKS, THE VEHICLE WILL START TO DROP AS SOON AS A JACK VALVE IS OPENED.

4. Push the pump run toggle switch to the "RUN" position. Hold the toggle switch to "RUN" until the equipment is fully retracted.
5. Move the valve release cam(s) to the "VALVE CLOSED" position and release the the pump run toggle switch.

NOTE: WHEN RETRACTING JACKS - Start with the front jacks. Alternate between the left and right jack several times, partially opening the jack valve slowly. This will allow the jacks to retract slightly each time, until the weight of the vehicle is off the jacks. This will reduce the possibility of twisting the vehicle. With the weight of the vehicle off the front jacks, open the front jack valves and use the pump run toggle switch. When both front jacks completely retracted, repeat the process with the rear jacks.

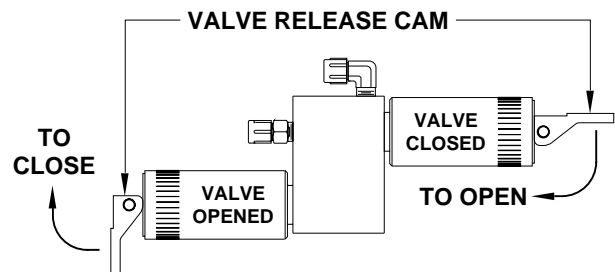

OPERATING PROCEDURES

AUXILIARY HAND PUMP OPERATION

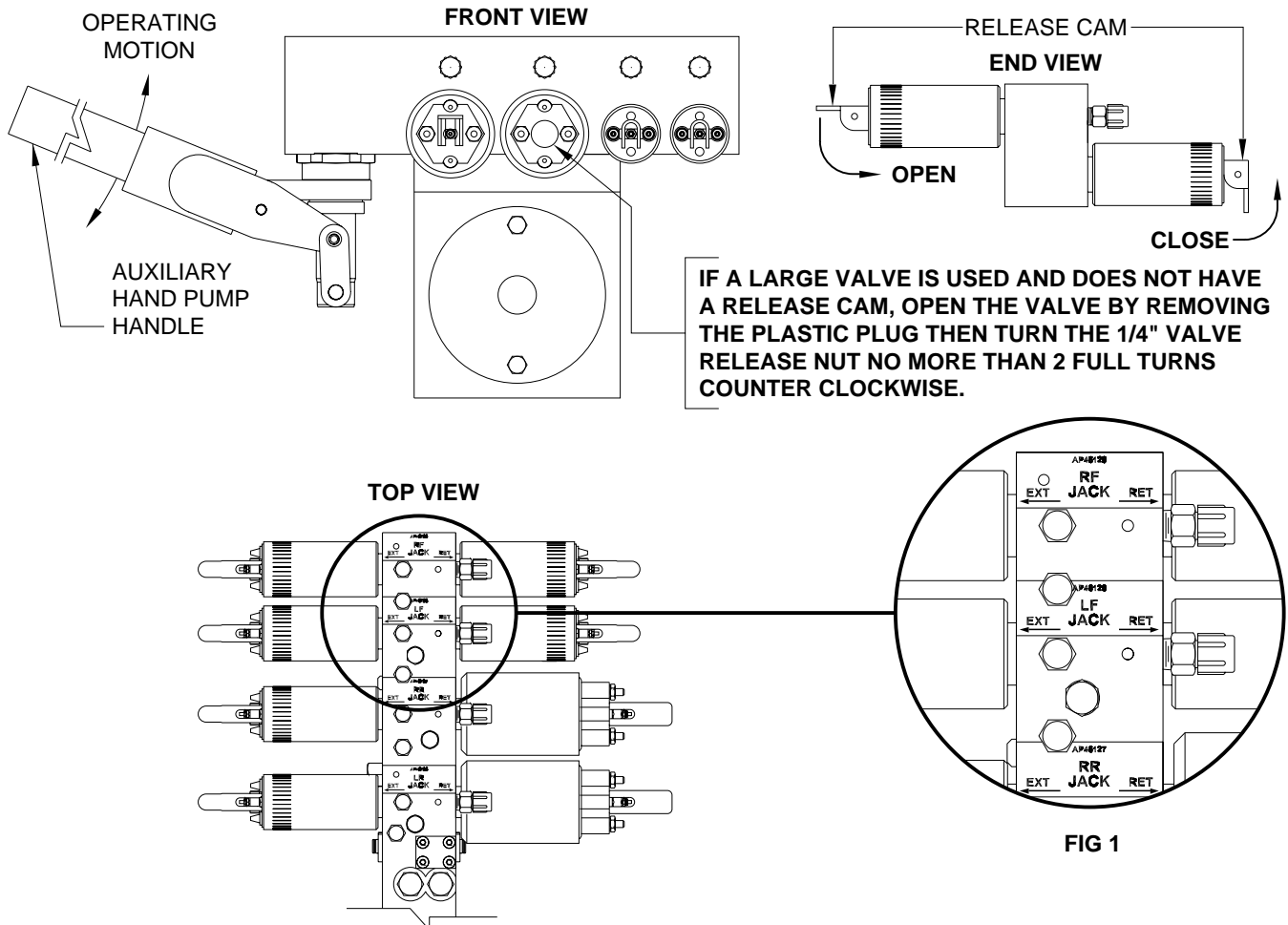

NOTE: Each hydraulic function requires a pair of solenoid valves one each for the extend and retract procedures. The number of functions and the items controlled by each pair of solenoid valves will vary for each system. The diagrams shown on this page represent a (4) function system indicated by the labels shown in FIG 1. Use the labels specific to your system when following these procedures.

The auxiliary hand pump can be used to extend or retract the jacks, room extensions or other HWH hydraulic equipment anytime the pump will not function. This includes functions that are controlled with a remote manifold.

The auxiliary hand pump is a two stage pump that will produce enough pressure to extend the landing gear and lift the vehicle as well as retract the landing gear. When operating the auxiliary pump to lift the vehicle or when the jacks are fully retracted, the pump handle will seem to "snap" as the pump goes to the second stage. The pumping action will be easier at first as the second stage starts to create more pressure.

NOTE: The hand pump will swivel to any position which will ease the operation of the hand pump.

To operate the auxiliary hand pump, open the appropriate solenoid valve. Insert the hand pump handle into the handle receptacle and move the handle in an up and down motion.

NOTE: If a room or step cannot be retracted using the auxiliary hand pump, see "MANUAL ROOM (or STEP) RETRACTION PROCEDURES".

The auxiliary hand pump may work easier if only one valve is open at a time. **Be careful to not twist the vehicle if only one solenoid valve is open.**

IMPORTANT: JACKS WILL START TO RETRACT IMMEDIATELY WHEN THE RELEASE CAM IS MOVED TO THE OPEN POSITION.

It is recommended to operate the auxiliary hand pump occasionally to check it's operation.

IMPORTANT: RELEASE CAM MIGHT BE ROTATED TO ANY DIRECTION ON THE VALVE. MAKE SURE TO MOVE THE RELEASE CAMS IN THE CORRECT DIRECTION. INCORRECT MOVEMENT OF THE CAMS CAN DAMAGE THE VALVES.

MAINTENANCE

PRIMING THE HAND PUMP

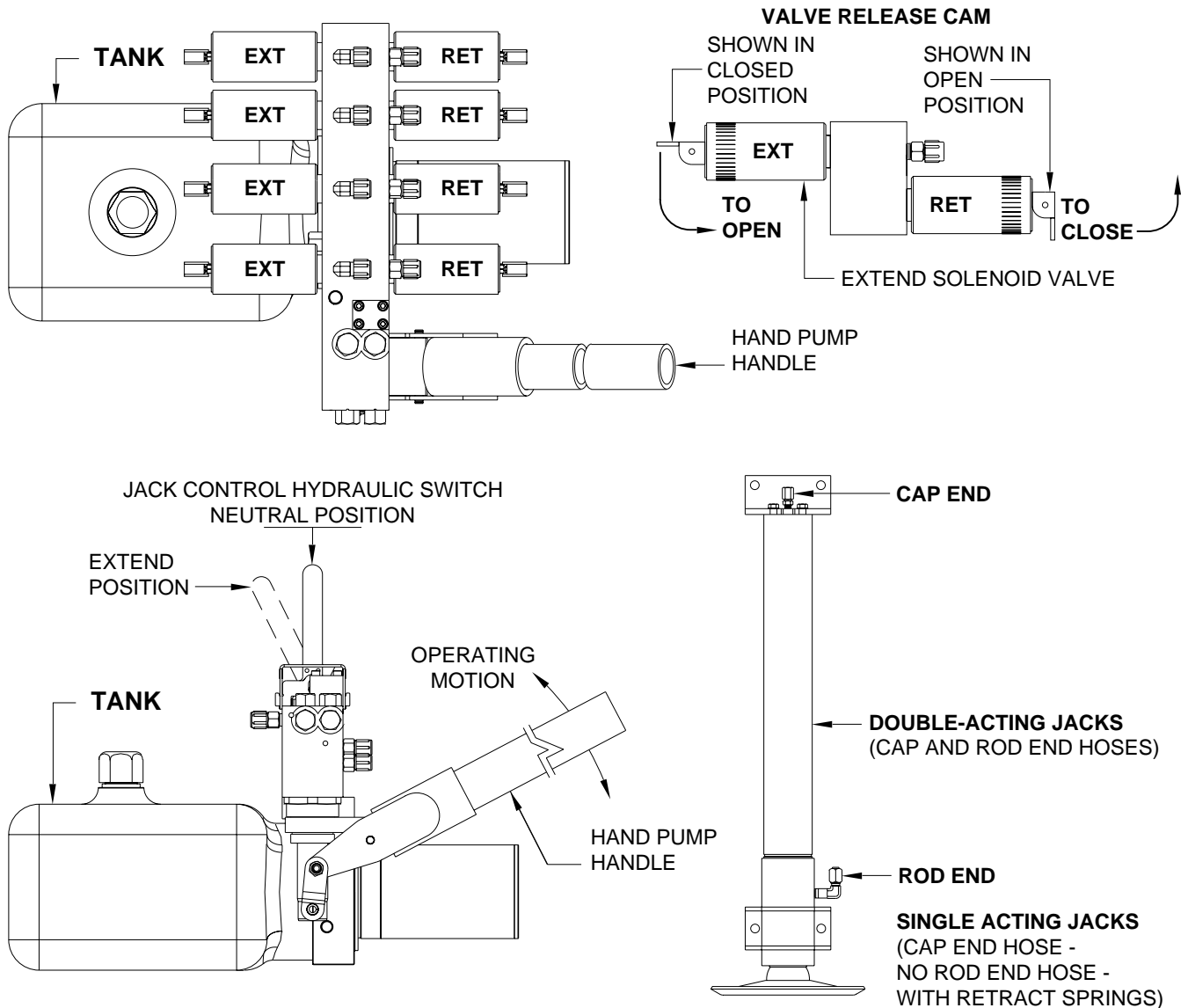

To prime the hand pump, it will be necessary to remove a hose from one of the jacks. One of the front jacks would be best, but use the easiest hose to get to.

If the system has Double-Acting cylinders on the front, remove the rod end hose from either of the front jacks. Place the end of the hose in a bucket. Make sure the tank is at least half full. Pump the hand pump until a healthy flow of oil is coming from the hose.

IMPORTANT: DO NOT ALLOW THE FLUID LEVEL IN THE TANK TO LOWER MORE THAN 1 INCH BEFORE ADDING FLUID.

Reattach the hose and retry the hand pump. Repeat the procedure if the hand pump does not move the jacks.

If the system has only Single-Acting jacks with return springs, remove the easiest hose to access and place the end in a bucket. Using the release cam, manually open the EXTEND solenoid valve for that jack (if equipped with solenoid valves) or move the jack control hydraulic switch to "EXTEND" for that jack. Make sure the tank is at least half full. Pump the hand pump until a healthy flow of fluid comes from the hose.

IMPORTANT: DO NOT ALLOW THE FLUID LEVEL IN THE TANK TO LOWER MORE THAN 1 INCH BEFORE ADDING FLUID.

Reattach the hose and retry the hand pump. Repeat the procedure if the hand pump does not move the jacks.

MAINTENANCE

OIL LEVEL

All maintenance should be done as part of the normal servicing of the coach.

The oil level should be checked when the vehicle is first purchased and then once every two years. More often if there is an oil leak in the system.

All jacks and any HWH steps should be completely retracted before checking the oil level. All HWH room extensions should be fully extended before checking the oil level. The oil reservoir is part of the pump / manifold assembly. The oil level is checked and filled through the breather cap. Clear any dirt away from the breather / filler cap before removing. The oil level should be within one inch of the top of the reservoir. Most breather caps have a dipstick.

NOTE: Overfilling the tank can cause leakage of oil through the breather cap.

FLUID: HWH Specialty Hydraulic Oil is recommended. In an emergency Dexron automatic transmission fluid can be used. **NOTE:** Dexron automatic transmission fluid contains red dye and can cause staining should a leak occur. **DO NOT USE** brake fluid or hydraulic jack fluid. Use of these can damage seals.

ELECTRICAL SYSTEM

The batteries should be in good condition and fully charged. Weak batteries can cause erratic operation. Battery cable terminals and battery posts and connections should be kept clean.

All electrical connections, especially ground connections, should be clean, tight, free from corrosion and protected from weathering.

JACKS

There are very few user serviceable parts on the jacks. The jacks require very little maintenance. If the jacks are extremely dirty with caked on mud they should be washed.

If extremely dirty, the jack rods should NOT be wiped. The jack rods do not need to be oiled or sprayed with anything. See ML47149 for proper maintenance of all jacks.

ROOM EXTENSIONS

The HWH room mechanisms need no maintenance. **DO NOT** grease or lubricate any parts of the HWH mechanism.

Any visible mechanism can be kept clean by washing with water. Refer to the vehicle manufacturer for correct maintenance of the room seals.

VISUAL INSPECTION

Periodically inspect the system for oil leaks and damaged or missing parts, such as pivot bolts or springs. Check the hydraulic lines and wiring for damage and wear. Check that the jacks do not interfere with any parts of the vehicle when they are in the "STORE" position.

The system will operate better if kept clean and free from caked on mud or ice.

OPERATIONAL CHECK

Review the OPERATOR MANUAL. Run the system according to the SYSTEM OPERATION Section. Note any abnormal operation.

Review the "JACK RETRACTION" Section. Make sure the jacks will fully retract to the "STORE" position. Jacks should not interfere with any of the coach when in the "STORE" position.

Check that all lights work according to the "INDICATOR LIGHT" Section. Correct function of the red "WARNING" light is important.

MAINTENANCE

NOT IN PARK/BRAKE CHECK

WARNING: WHEN MAKING THIS CHECK, BLOCK THE COACH WHEELS SECURELY SO THE COACH CANNOT ROLL FORWARD OR BACKWARD.

Apply the brake so the coach cannot roll. Turn the ignition to the "ACC" or "ON" position. Release the parking brake. Push the "AUTO LEVEL" button. The "NOT IN PARK/BRAKE" indicator light should come on while the "AUTO LEVEL" button is pushed. Release the "AUTO LEVEL" button and set the park brake. The leveling system should now function.

If any of the above checks or inspections reveal a problem or if there are other problems or questions, consult a qualified RV repair center, your vehicle or coach manufacturer, or HWH CORPORATION for service or repair.

WINTER WEATHER DRIVING

Anti-icing / deicing agents when splashed on your vehicle, continue to absorb moisture from the air even after they have dried. This can facilitate corrosion of metallic components, such as HWH jacks.

To help reduce the corrosion of jacks after exposure to anti-icing / deicing agents, thoroughly wash jacks with warm soapy water.

INSTRUCTION SHEET

SENSING UNIT MAINTENANCE/SERVICE

REMOTE MOUNTED "POTTED" ELECTRONIC SENSING UNIT

SENSING UNIT ACCURACY TOLERANCE

The sensing unit has an accuracy tolerance of ± 5.4 inches front to rear and ± 1 inch side to side on a 36 foot vehicle. Typical leveling results will be better.

SENSING UNIT ADJUSTMENT / WITH ADJUSTING ENHANCEMENT

Level the vehicle by placing a bubble level in the center of the freezer floor or upon whichever surface within the vehicle that is to be level. It is best if the level is placed close to the mounting area of the sensing unit. Using the Leveling System and the bubble level, ignoring the yellow LEVEL lights on the Touch Panel, level the vehicle until the bubble is centered.

With the vehicle level according to the bubble level, if there are no yellow lights lit on the Touch Panel, the sensing unit is properly adjusted. If there are yellow LEVEL lights lit on the Touch Panel, manual adjustments to the Sensing Unit are needed.

The ignition (motorized units) or master power switch (towable units) must be on. Remove the "Adjusting Enhancement Cap". **DO NOT LOSE THIS CAP.** There is a small pin beneath the cap. Use a jumper wire with an alligator clip to apply a ground to the pin. This will make the sensing unit very sensitive. The yellow lights may "jump" around while adjusting the sensing unit. Let the lights settle down after each adjustment. Small, gentle turns will work best. Turn mounting screws 1 and 3 to adjust the sensing unit. Turn screws as instructed to turn out all the yellow LEDs. When all the LEDs are out, remove the jumper wire and replace the adjusting enhancement cap. **DO NOT** over tighten.

Move the vehicle to an unlevel position and level the vehicle according to the yellow level sensing lights on the touch panel. Readjust if necessary.

IMPORTANT: THE SENSING UNIT MOUNTING SPRINGS SHOULD BE COMPRESSED ABOUT 1/2 THEIR FREE LENGTH. SCREW NUMBER 2 SHOULD NOT BE TURNED WHILE ADJUSTING THE SENSING UNIT. AFTER ADJUSTING THE SENSING UNIT, BUMP THE SENSING UNIT TO SEE THAT IT IS SETTLED TIGHT AGAINST ALL THREE SCREW HEADS AND STILL INDICATES THAT THE UNIT IS LEVEL.

NOTE: If opposing LED's are lit, there is a problem with the Sensing Unit.

If LED (A) is lit: Tighten adjustment screw number 1 until the LED is off.

If LED (C) is lit: Loosen adjustment screw number 1 until the LED is off.

If LED (B) is lit: Loosen adjustment screw number 3 until the LED is off.

If LED (D) is lit: Tighten adjustment screw number 3 until the LED is off.

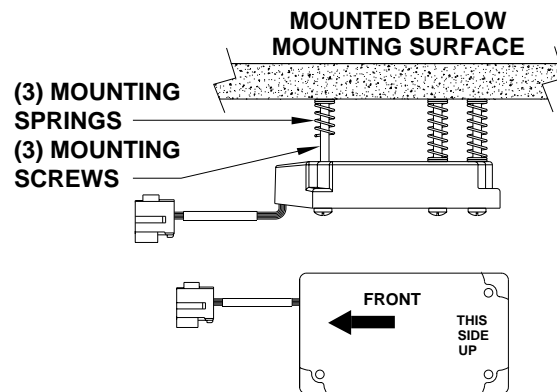
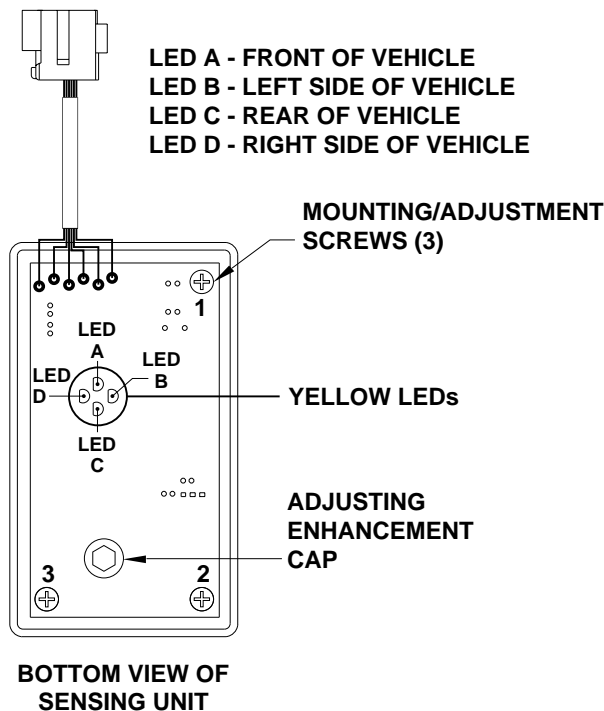

INFORMATION/INSTRUCTION SHEET

HYDRAULIC SOLENOID VALVE

IDENTIFICATION - MANUAL OPERATIONS - REPLACEMENT

REPLACEMENT VALVES WILL HAVE A VALVE RELEASE CAM

BREATHER CAP W/NUT DRIVER

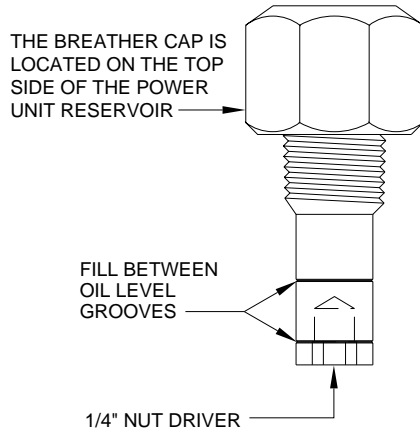

IMPORTANT: PRIOR TO REMOVING THE BREATHER CAP, EITHER TO CHECK THE OIL LEVEL OR TO USE 1/4" NUT DRIVER, CLEAN ANY DEBRIS FROM THE TOP OF THE RESERVOIR. BEFORE RETURNING THE BREATHER CAP TO THE RESERVOIR, REMOVE ANY PAINT CHIPS OR OTHER DEBRIS FROM THE DIPSTICK INCLUDING DEBRIS INSIDE THE 1/4" NUT DRIVER.

SOLENOID VALVES WITH CAM RELEASE

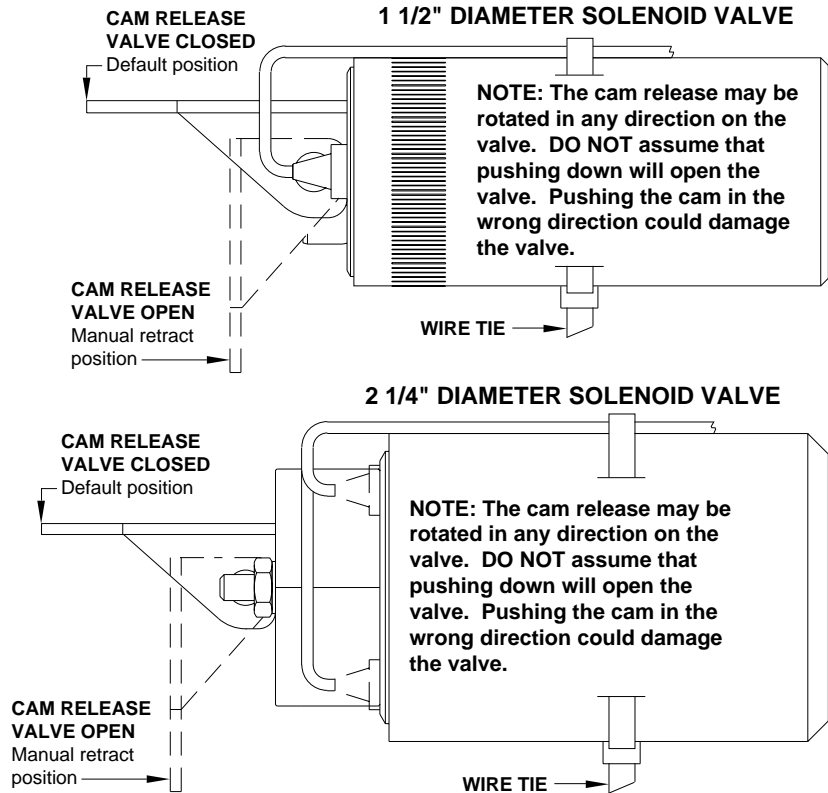

SOLENOID VALVES WITH 1/4" NUT RELEASE

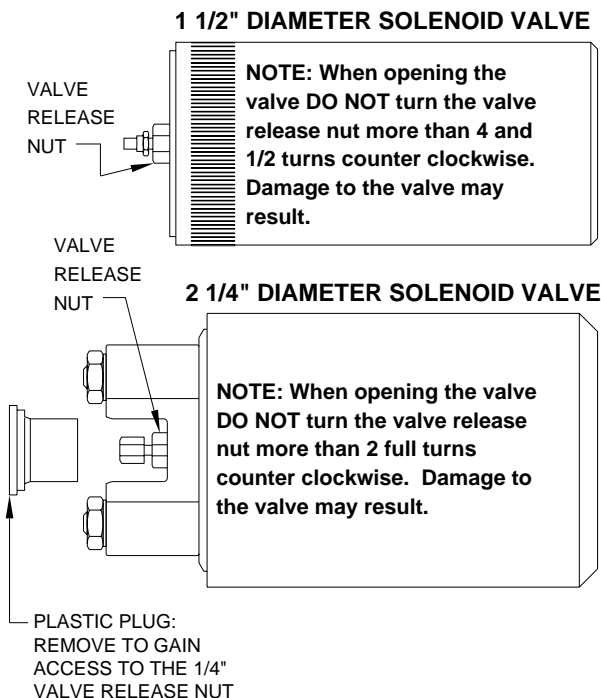

SOLENOID VALVES WITH T-HANDLE RELEASE

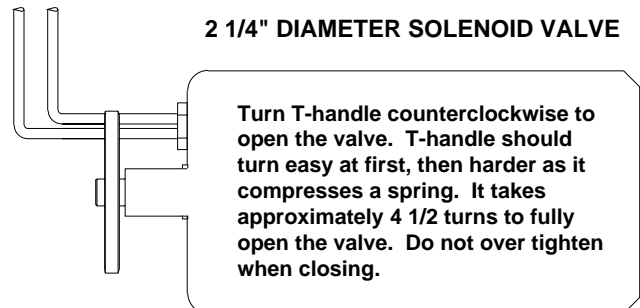

NOTE: OLD STYLE HEX SHAPED SOLENOID VALVES HAVE NO MANUAL VALVE RELEASE.