

AP24299  
FRONT AIR MODULE

← AP26075

← AP26074

\* DESIGNATES PIN 1 OF CONNECTORS

AP26075 CN1 (BROWN)

- PIN
- 1 N/C
  - 2 BLK(W1500) LEFT FRONT RAISE
  - 3 BLK(W1600) LEFT FRONT LOWER
  - 4 BLK(W2500) RIGHT FRONT RAISE
  - 5 BLK(W2600) RIGHT FRONT LOWER
  - 6 BLK(W9700) COMPRESSOR
  - 7 N/C
  - 8 BLK(W1700) TRAVEL
  - 9 N/C
  - 10 N/C
  - 11 WHT(W6254) GROUND
  - 12 N/C

AP26075 CN98 (GRAY)

- PIN
- 1 RED (W6800) SW BATT
  - 2 RED (W6800) SW BATT
  - 3 GRN (W6230) GND
  - 4 GRN (W6230) GND

AP26075 CN1 (BLACK)

- PIN
- 1 N/C
  - 2 N/C
  - 3 RED(W6800) SW BATTERY
  - 4 GRN(W6230) GROUND
  - 5 CAN SHIELD
  - 6 N/C
  - 7 GRN CAN LOW
  - 8 YEL CAN HI

AP26074 CN9 (BLACK)

- PIN
- 1 WHT(W7696) SYSTEM WAKE UP
  - 2 N/C
  - 3 RED(W6800) SW BATTERY
  - 4 GRN(W6230) GROUND
  - 5 CAN SHIELD
  - 6 RED(W6110) IGNITION
  - 7 GRN CAN LOW
  - 8 YEL CAN HI

AP26074 CN10 (GRAY)

- PIN
- 1 N/C
  - 2 N/C
  - 3 N/C
  - 4 N/C
  - 5 N/C
  - 6 N/C

AP26074 CN12 (GRAY)

- PIN
- 1 N/C
  - 2 N/C
  - 3 N/C
  - 4 N/C
  - 5 N/C
  - 6 WHT(W6236) GROUND
  - 7 BLK(W6800) SW. BATTERY
  - 8 N/C
  - 9 N/C
  - 10 BLK(W2210) RIGHT FRONT PSW
  - 11 BLK(W7521) TAG DUMP SW.
  - 12 N/C

AP26074 CN11 (GREEN)

- PIN
- 1 N/C
  - 2 N/C
  - 3 N/C
  - 4 N/C
  - 5 N/C
  - 6 WHT(W6235) GROUND
  - 7 N/C
  - 8 N/C
  - 9 N/C
  - 10 BLK(W1210) LEFT FRONT PSW
  - 11 N/C
  - 12 N/C

|  |      |                       |              |  |  |
|--|------|-----------------------|--------------|--|--|
|  |      | HWH                   |              | I-80 EXIT 267 SOUTH<br>RT 1 MOSCOW, IOWA 52760 |  |
|  |      | SCALE 1:3             | DATE 18JUL05 | DRAWN BY .                                     |  |
|  |      | SYSTEM SCHEMATIC ELEC |              |  |  |
| NO.  | DATE | REVISION              |              |  |  |
| THE INFORMATION DISCLOSED ON THIS DRAWING IS CONFIDENTIAL AND MUST NOT BE DISCLOSED OR USED IN ANY MANNER WHICH WILL BE DETRIMENTAL TO THE HWH CORPORATION |      |                       |              | DRAWING NUMBER<br>MP88691 A/0                  |  |

AP24887  
CENTRAL CONTROL/ROOM MODULE

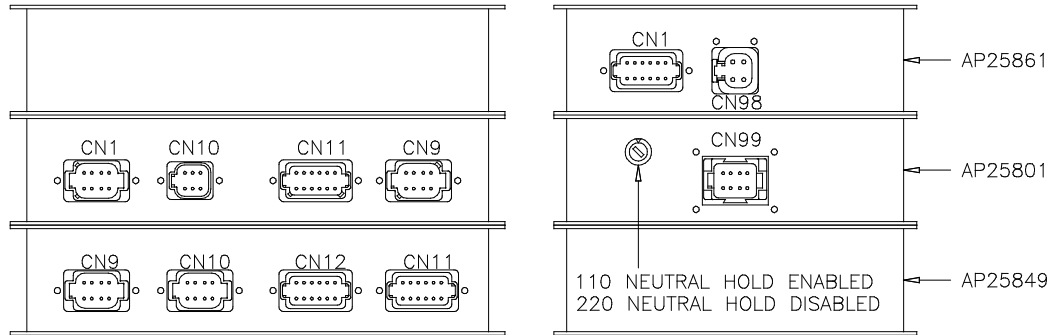

AP25861 CN1 (BROWN)  
PIN

|    |            |                   |
|----|------------|-------------------|
| 1  | BLK(W5050) | CYLINDER EXTEND1  |
| 2  | BLK(W5150) | CYLINDER RETRACT1 |
| 3  | BLK(W5200) | LOCK ROOM 1       |
| 4  | BLK(W5300) | UNLOCK ROOM 1     |
| 5  | N/C        |                   |
| 6  | N/C        |                   |
| 7  | BLK(W5600) | AIR SEAL          |
| 8  | BLK(W5650) | VACUUM            |
| 9  | N/C        |                   |
| 10 | N/C        |                   |
| 11 | N/C        |                   |
| 12 | N/C        |                   |

AP25861 CN98 (GRAY)  
PIN

|   |             |         |
|---|-------------|---------|
| 1 | RED (W6801) | SW BATT |
| 2 | RED (W6801) | SW BATT |
| 3 | GRN (W6230) | GND     |
| 4 | GRN (W6230) | GND     |

AP25801 CN1 (BLACK)  
PIN

|   |             |                |
|---|-------------|----------------|
| 1 | WHT(W7696)  | SYSTEM WAKE UP |
| 2 | N/C         |                |
| 3 | RED(W6800)  | SW BATT        |
| 4 | GRN(W6230)  | GND            |
| 5 | CAN SHIELD  |                |
| 6 | RED(W6110)  | IGNITION       |
| 7 | GRN CAN LOW |                |
| 8 | YEL CAN HI  |                |

AP25801 CN10 (GRAY)  
PIN

|   |             |                   |
|---|-------------|-------------------|
| 1 | WHT (W7599) | RST LGT CNTRL     |
| 2 | WHT (W6100) | RST LGT SUPPLY    |
| 3 | WHT (W7550) | RST BUTTON CNTRL  |
| 4 | WHT (W6121) | WARN LIGHT SUPPLY |
| 5 | WHT (W6230) | RESET BUTTON GND  |
| 6 | WHT (W7699) | WARN LIGHT CNTRL  |

AP25801 CN11 (GRAY)  
PIN

|    |             |                   |
|----|-------------|-------------------|
| 1  | RED (W6110) | IGNITION          |
| 2  | N/C         |                   |
| 3  | N/C         |                   |
| 4  | N/C         |                   |
| 5  | RED (W6120) | ACCESSORY         |
| 6  | RED (W6101) | HOUSE BATTERY     |
| 7  | GRN (W6230) | GROUND            |
| 8  | WHT (W9961) | NEUTRAL HOLD      |
| 9  | WHT (W9955) | NEUTRAL HOLD      |
| 10 | N/C         |                   |
| 11 | WHT (W9000) | PARK BRAKE SWITCH |
| 12 | RED (W6100) | ENGINE BATTERY    |

AP25801 CN9 (GREEN)  
PIN

|   |             |                         |
|---|-------------|-------------------------|
| 1 | BLK (W8500) | MASTER RELAY CNTRL      |
| 2 | BLK (W8100) | SYSTEM PSW.             |
| 3 | N/C         |                         |
| 4 | BLK (W8600) | PMP RELAY CNTRL         |
| 5 | BLK (W9900) | SPEED SWITCH            |
| 6 | BLK (W9901) | SW BATT FROM PUMP RELAY |
| 7 | N/C         |                         |
| 8 | N/C         |                         |

AP25801 CN99 (GRAY)  
PIN

|   |      |  |
|---|------|--|
| 1 | RED  |  |
| 2 | GRN  |  |
| 3 | BLK  |  |
| 4 | YELW |  |
| 5 | WHT  |  |
| 6 | N/C  |  |
| 7 | N/C  |  |
| 8 | N/C  |  |

AP25849 CN9 (BLACK)  
PIN

|   |             |                |
|---|-------------|----------------|
| 1 | WHT(W7696)  | SYSTEM WAKE UP |
| 2 | N/C         |                |
| 3 | RED(W6800)  | SW BATTERY     |
| 4 | GRN(W6230)  | GROUND         |
| 5 | CAN SHIELD  |                |
| 6 | RED(W6110)  | IGNITION       |
| 7 | GRN CAN LOW |                |
| 8 | YEL CAN HI  |                |

AP25849 CN10 (GRAY)  
PIN

|   |            |                  |
|---|------------|------------------|
| 1 | N/C        |                  |
| 2 | WHT(W7510) | READY TO OPERATE |
| 3 | WHT(W7530) | PUMP             |
| 4 | WHT(W7501) | EXTEND           |
| 5 | WHT(W7502) | RETRACT          |
| 6 | RED(W6805) | SW BATTERY       |
| 7 | WHT(W7631) | CAN STATUS LINE  |
| 8 | GRN(W6230) | GROUND           |

AP25849 CN12 (GRAY)  
PIN

|    |            |                           |
|----|------------|---------------------------|
| 1  | BLK(W5706) | LOWER FRONT UNLOCK        |
| 2  | BLK(W5701) | FRONT ROOM OUT            |
| 3  | N/C        |                           |
| 4  | BLK(W5710) | LOWER FRONT LOCK          |
| 5  | N/C        |                           |
| 6  | WHT(W6230) | GROUND                    |
| 7  | RED(W6121) | SW BATTERY                |
| 8  | N/C        |                           |
| 9  | BLK(W5708) | UPPER FRONT LOCK          |
| 10 | BLK(W5703) | UPPER FRONT ROOM IN       |
| 11 | BLK(W7695) | PRESS. SW. SYNCH CYLINDER |
| 12 | BLK(W5704) | UPPER FRONT UNLOCK        |

AP25849 CN 11 (GREEN)  
PIN

|    |            |                    |
|----|------------|--------------------|
| 1  | BLK(W5707) | LOWER REAR UNLOCK  |
| 2  | N/C        |                    |
| 3  | N/C        |                    |
| 4  | BLK(W5711) | LOWER REAR LOCK    |
| 5  | N/C        |                    |
| 6  | N/C        |                    |
| 7  | RED(W6120) | SW BATTERY         |
| 8  | N/C        |                    |
| 9  | BLK(W5709) | UPPER REAR LOCK    |
| 10 | BLK(W5702) | UPPER REAR ROOM IN |
| 11 | N/C        |                    |
| 12 | BLK(W5705) | UPPER REAR UNLOCK  |

AP26108 CN1 (BLACK)

| PIN | Color | Wiring  | Function         |
|-----|-------|---------|------------------|
| 1   | BLK   | (W3800) | TAG LIFT         |
| 2   | BLK   | (W4500) | LEFT REAR RAISE  |
| 3   | BLK   | (W4600) | LEFT REAR LOWER  |
| 4   | BLK   | (W3500) | RIGHT REAR RAISE |
| 5   | BLK   | (W3600) | RIGHT REAR LOWER |
| 6   | N/C   |         |                  |
| 7   | BLK   | (W3701) | TAG TRAVEL       |
| 8   | BLK   | (W3700) | TRAVEL           |
| 9   | BLK   | (W3601) | TAG RIGHT LOWER  |
| 10  | BLK   | (W4601) | TAG LEFT LOWER   |
| 11  | WHT   | (W6258) | GROUND           |
| 12  | N/C   |         |                  |

AP26108 CN98 (GRAY)

| PIN | Color | Wiring  | Function |
|-----|-------|---------|----------|
| 1   | RED   | (W6800) | SW BATT  |
| 2   | RED   | (W6800) | SW BATT  |
| 3   | GRN   | (W6230) | GND      |
| 4   | GRN   | (W6230) | GND      |

AP25916 CN9 (BLACK)

| PIN | Color      | Wiring  | Function       |
|-----|------------|---------|----------------|
| 1   | WHT        | (W7696) | SYSTEM WAKE UP |
| 2   | N/C        |         |                |
| 3   | RED        | (W6800) | SW BATTERY     |
| 4   | GRN        | (W6230) | GROUND         |
| 5   | CAN SHIELD |         |                |
| 6   | RED        | (W6110) | IGNITION       |
| 7   | GRN        |         | CAN LOW        |
| 8   | YLW        |         | CAN HI         |

AP25916 CN10 (GRAY)

| PIN | Color | Wiring | Function |
|-----|-------|--------|----------|
| 1   | N/C   |        |          |
| 2   | N/C   |        |          |
| 3   | N/C   |        |          |
| 4   | N/C   |        |          |
| 5   | N/C   |        |          |
| 6   | N/C   |        |          |

AP25916 CN12 (GRAY)

| PIN | Color | Wiring  | Function             |
|-----|-------|---------|----------------------|
| 1   | N/C   |         |                      |
| 2   | N/C   |         |                      |
| 3   | BLK   | (W3215) | AIR SYSTEM PRESS SW. |
| 4   | N/C   |         |                      |
| 5   | N/C   |         |                      |
| 6   | WHT   | (W6235) | GROUND               |
| 7   | N/C   |         |                      |
| 8   | N/C   |         |                      |
| 9   | N/C   |         |                      |
| 10  | N/C   |         |                      |
| 11  | N/C   |         |                      |
| 12  | N/C   |         |                      |

AP25916 CN11 (GREEN)

| PIN | Color | Wiring | Function |
|-----|-------|--------|----------|
| 1   | N/C   |        |          |
| 2   | N/C   |        |          |
| 3   | N/C   |        |          |
| 4   | N/C   |        |          |
| 5   | N/C   |        |          |
| 6   | N/C   |        |          |
| 7   | N/C   |        |          |
| 8   | N/C   |        |          |
| 9   | N/C   |        |          |
| 10  | N/C   |        |          |
| 11  | N/C   |        |          |
| 12  | N/C   |        |          |

AP25150 REAR AIR MODULE

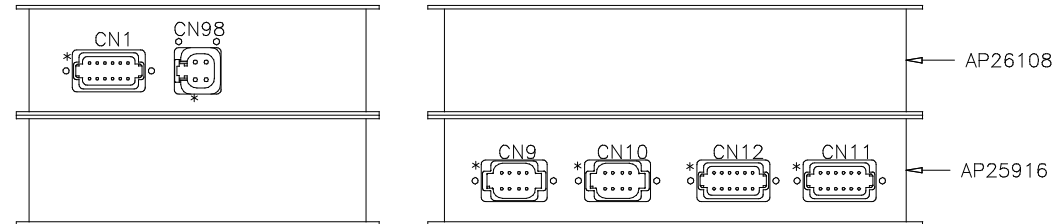

\* DESIGNATES PIN 1 OF CONNECTORS

NOTE: 120 OHM TERMINATING RESISTOR ON TOUCH PANEL. MEASURE RESISTANCE VALUE ACROSS PINS 7 AND 8 ON THE BLACK 8 PIN CAN CONNECTOR. RESISTANCE WILL READ THE TWO TERMINATING RESISTORS IN PARALLEL.

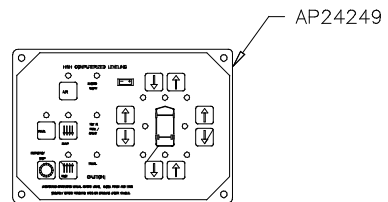

5 1

- PIN
- 1 YELLOW CAN HI
  - 2 GREEN CAN LOW
  - 3 CAN SHIELD
  - 4 GRN (W6230) GROUND
  - 5 RED (W6800) SW. BATTERY

OEM PROVIDED

RIGHT FRONT RAISE

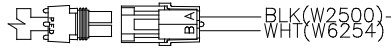

RIGHT FRONT LOWER

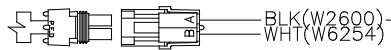

RIGHT FRONT TRAVEL

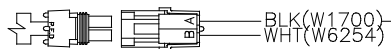

LEFT FRONT TRAVEL

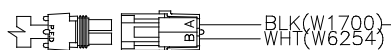

LEFT FRONT LOWER

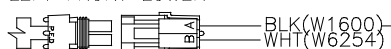

LEFT FRONT RAISE

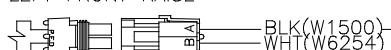

COMPRESSOR

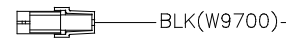

PART OF AP25149

OEM PROVIDED

AP24299  
FRONT AIR MODULE

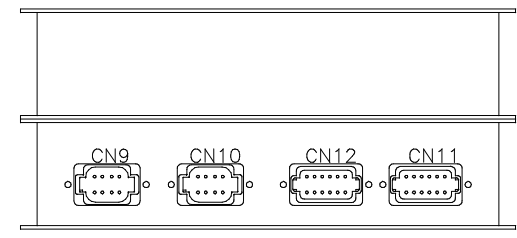
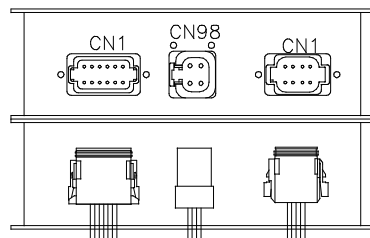

NO CONNECTIONS

PART OF AP25149

LEFT FRONT PRESSURE SWITCH

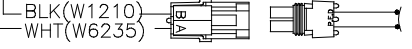

RIGHT FRONT PRESSURE SWITCH

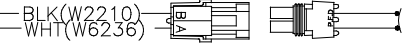

BLK(W6800) TAG DUMP SWITCH  
BLK(W7521) TAG DUMP SWITCH

OEM PROVIDED

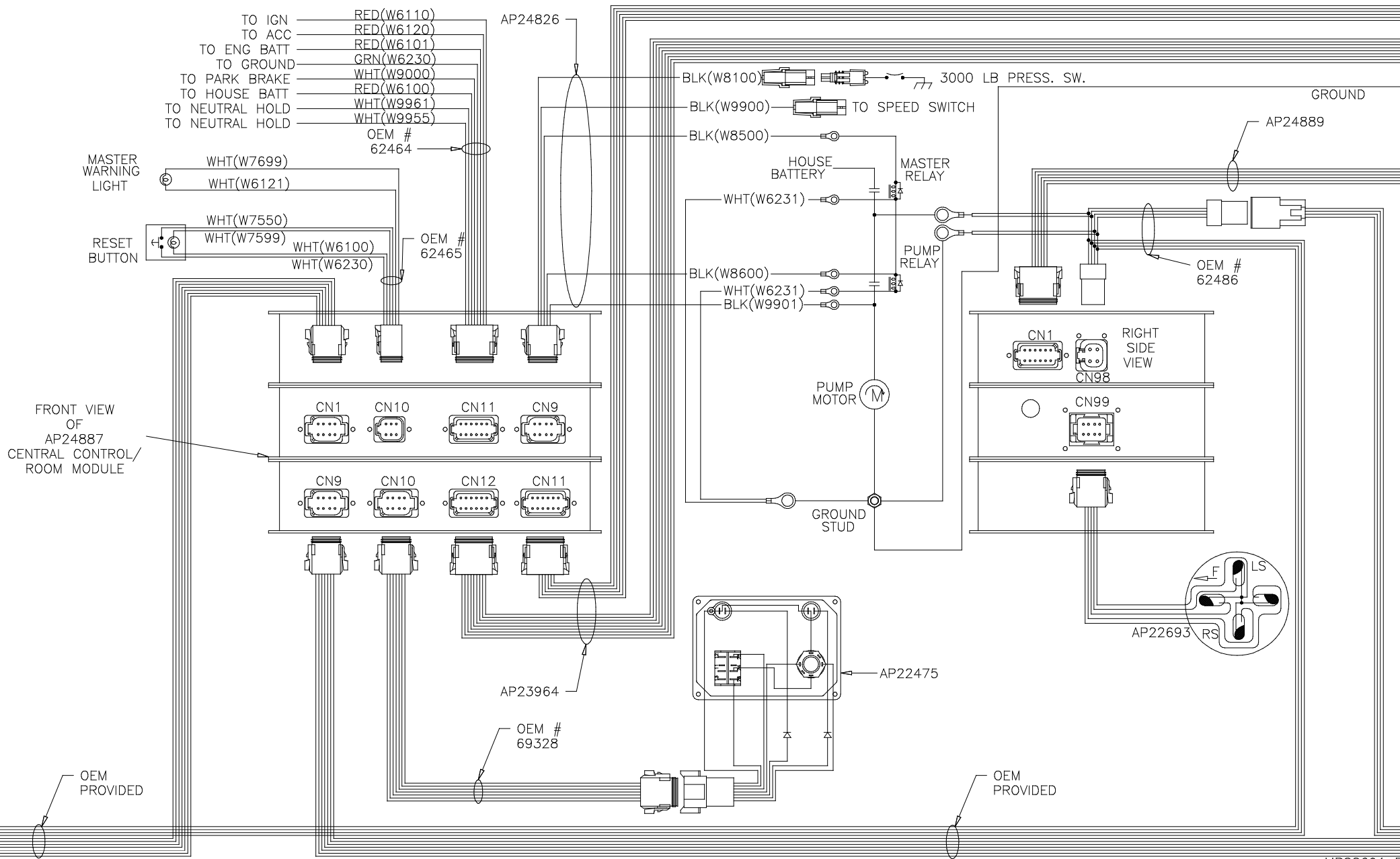

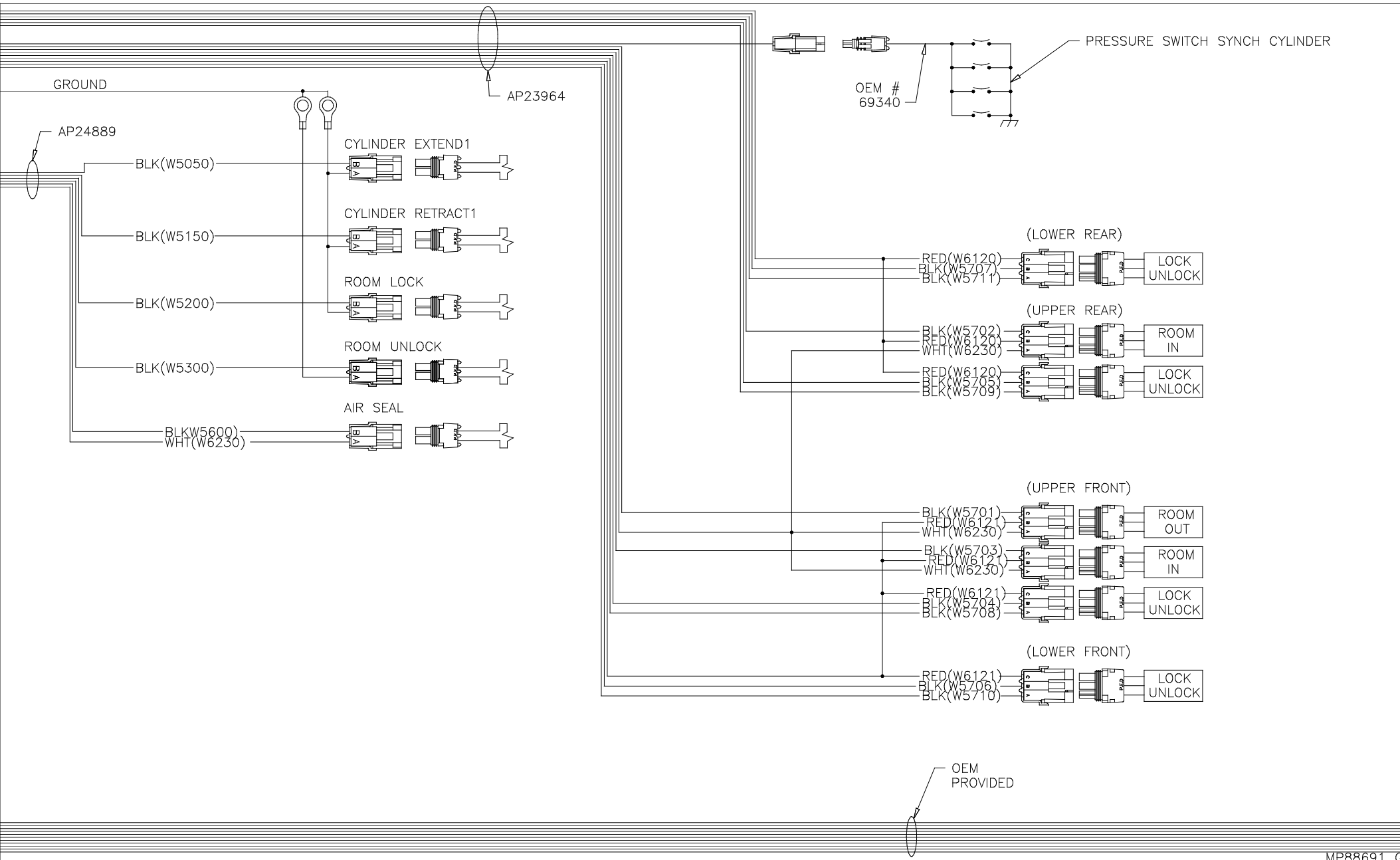

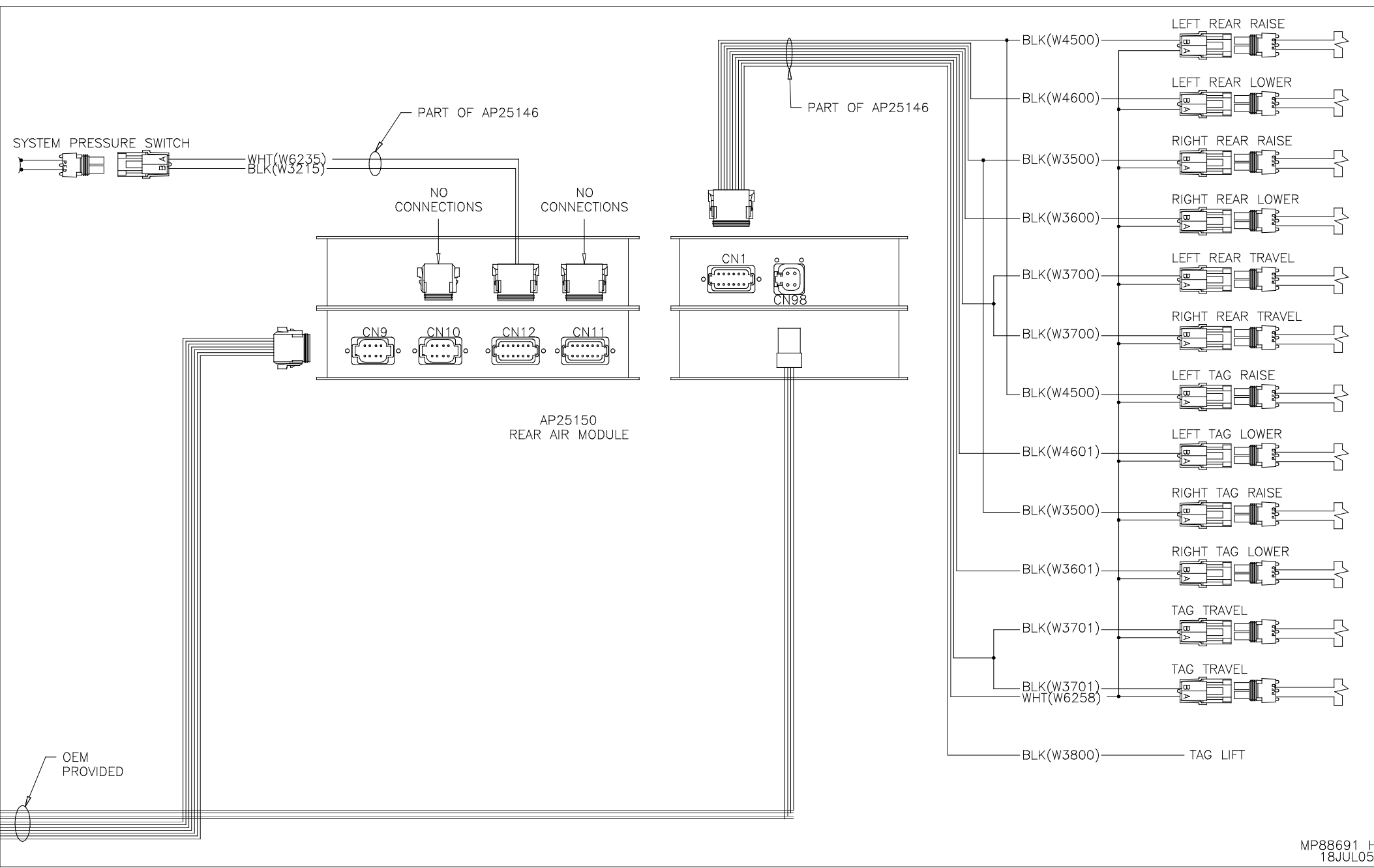



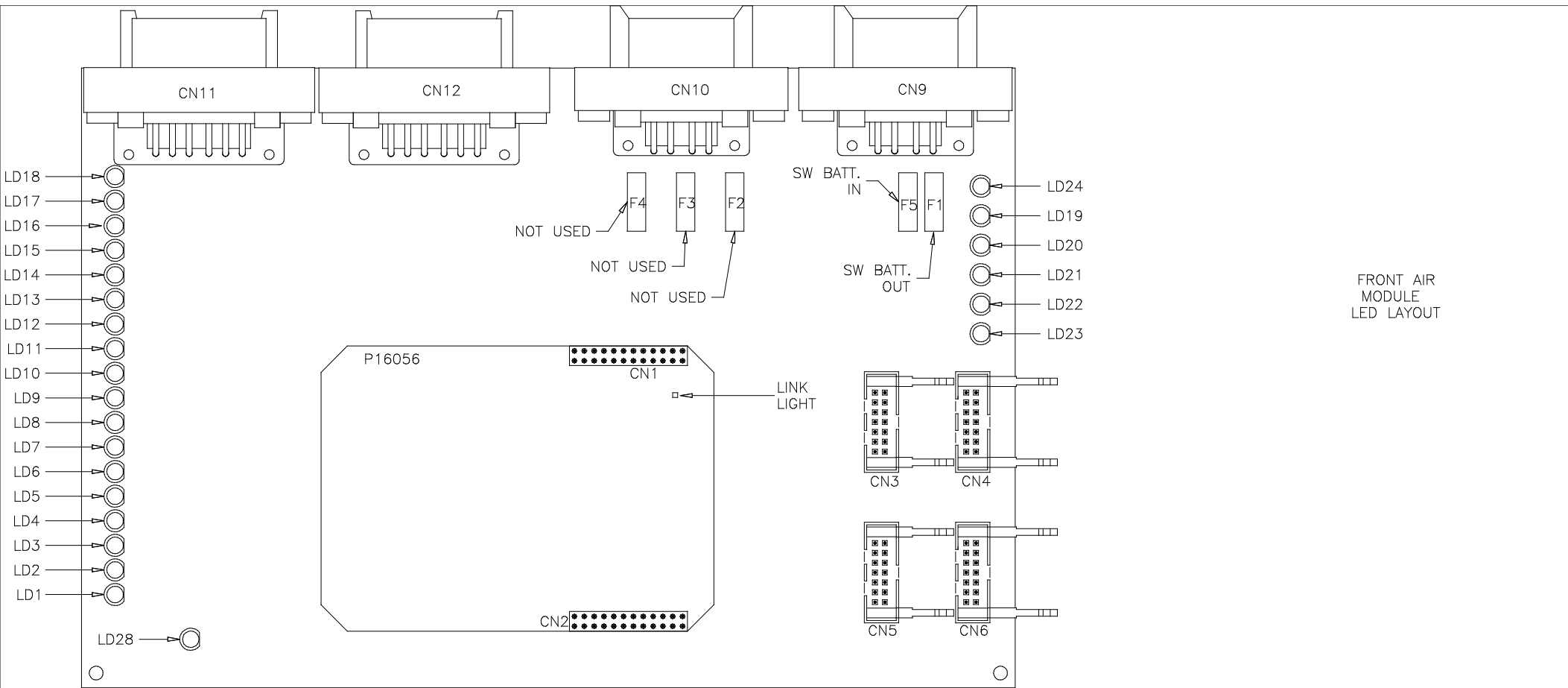

FRONT AIR  
MODULE  
LED LAYOUT

| LED #  | CONNECTOR    | COLOR  | DESCRIPTION     |
|--------|--------------|--------|-----------------|
| LED 1  | NOT USED     | RED    | NOT USED        |
| LED 2  | NOT USED     | RED    | NOT USED        |
| LED 3  | NOT USED     | GREEN  | NOT USED        |
| LED 4  | NOT USED     | YELLOW | NOT USED        |
| LED 5  | NOT USED     | YELLOW | NOT USED        |
| LED 6  | NOT USED     | YELLOW | NOT USED        |
| LED 7  | NOT USED     | GREEN  | NOT USED        |
| LED 8  | NOT USED     | GREEN  | NOT USED        |
| LED 9  | CN 11 PIN 10 | GREEN  | LEFT FRONT PSW  |
| LED 10 | CN 12 PIN 10 | GREEN  | RIGHT FRONT PSW |
| LED 11 | NOT USED     | YELLOW | NOT USED        |
| LED 12 | NOT USED     | YELLOW | NOT USED        |
| LED 13 | NOT USED     | YELLOW | NOT USED        |
| LED 14 | NOT USED     | YELLOW | NOT USED        |

| LED #  | CONNECTOR    | COLOR | DESCRIPTION     |
|--------|--------------|-------|-----------------|
| LED 15 | NOT USED     | GREEN | NOT USED        |
| LED 16 | NOT USED     | GREEN | NOT USED        |
| LED 17 | NOT USED     | GREEN | NOT USED        |
| LED 18 | NOT USED     | GREEN | NOT USED        |
| LED 19 | NOT USED     | RED   | SW BATT OUT     |
| LED 20 | NOT USED     | RED   | SW BATT IN      |
| LED 21 | NOT USED     | RED   | NOT USED        |
| LED 22 | NOT USED     | RED   | NOT USED        |
| LED 23 | NOT USED     | RED   | NOT USED        |
| LED 24 | NOT USED     | RED   | NOT USED        |
| LED 25 | ---          | ---   | ---             |
| LED 26 | ---          | ---   | ---             |
| LED 27 | ---          | ---   | ---             |
| LED 28 | CN 12 PIN 11 | RED   | TAG DUMP SWITCH |

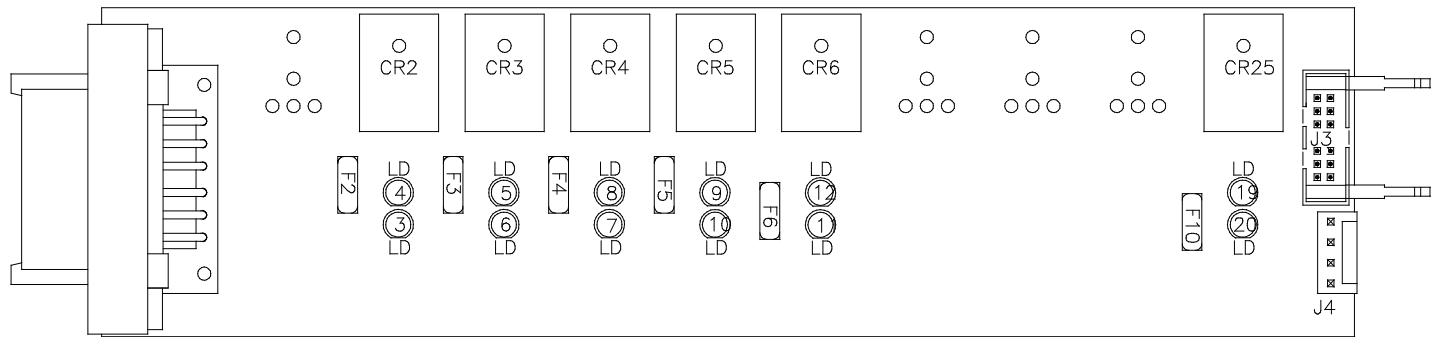

FRONT AIR  
OUTPUT  
LED LAYOUT

| LED # | COLOR  | INPUT J3 | FUSE #  | OUTPUT | RELAY # | DESCRIPTION                 |
|-------|--------|----------|---------|--------|---------|-----------------------------|
| LED1  | ---    | ---      | ---     | ---    | ---     | ---                         |
| LED2  | ---    | ---      | ---     | ---    | ---     | ---                         |
| LED3  | RED    | ---      | FUSE 2  | PIN 2  | CR2     | LEFT FRONT RAISE (CONTACT)  |
| LED4  | YELLOW | PIN 12   | ---     | ---    | CR2     | LEFT FRONT RAISE (COIL)     |
| LED5  | YELLOW | PIN 11   | ---     | ---    | CR3     | LEFT FRONT LOWER (COIL)     |
| LED6  | RED    | ---      | FUSE 3  | PIN 3  | CR3     | LEFT FRONT LOWER (CONTACT)  |
| LED7  | RED    | ---      | FUSE 4  | PIN 4  | CR4     | RIGHT FRONT RAISE (CONTACT) |
| LED8  | YELLOW | PIN 10   | ---     | ---    | CR4     | RIGHT FRONT RAISE (COIL)    |
| LED9  | YELLOW | PIN 9    | ---     | ---    | CR5     | RIGHT FRONT LOWER (COIL)    |
| LED10 | RED    | ---      | FUSE 5  | PIN 5  | CR5     | RIGHT FRONT LOWER (CONTACT) |
| LED11 | RED    | ---      | FUSE 6  | PIN 6  | CR6     | COMPRESSOR (CONTACT)        |
| LED12 | YELLOW | PIN 8    | ---     | ---    | CR6     | COMPRESSOR (COIL)           |
| LED13 | ---    | ---      | ---     | ---    | ---     | ---                         |
| LED14 | ---    | ---      | ---     | ---    | ---     | ---                         |
| LED15 | ---    | ---      | ---     | ---    | ---     | ---                         |
| LED16 | ---    | ---      | ---     | ---    | ---     | ---                         |
| LED17 | ---    | ---      | ---     | ---    | ---     | ---                         |
| LED18 | ---    | ---      | ---     | ---    | ---     | ---                         |
| LED19 | YELLOW | PIN 4    | ---     | ---    | CR25    | TRAVEL (COIL)               |
| LED20 | RED    | ---      | FUSE 10 | PIN 8  | CR25    | TRAVEL (CONTACT)            |

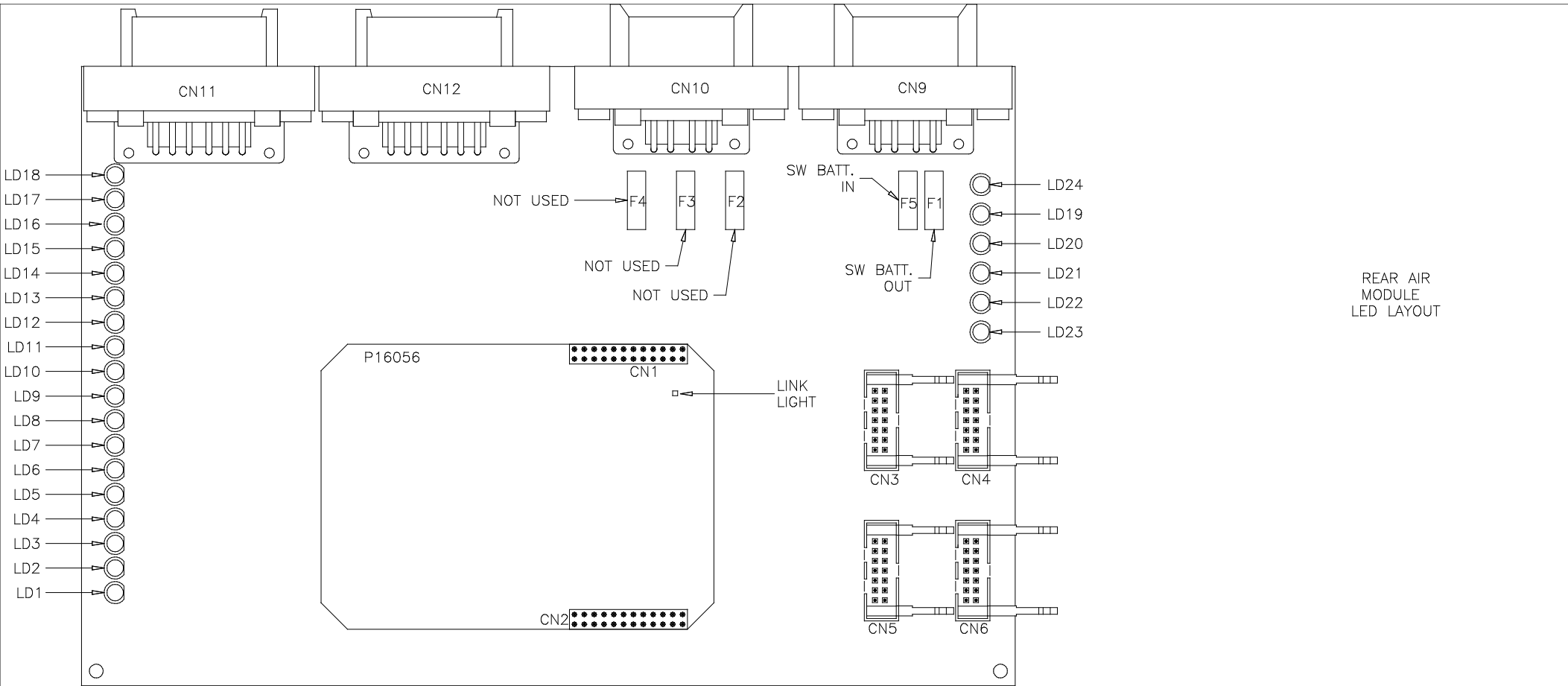

| LED #  | CONNECTOR   | COLOR  | DESCRIPTION     |
|--------|-------------|--------|-----------------|
| LED 1  | NOT USED    | RED    | NOT USED        |
| LED 2  | NOT USED    | RED    | NOT USED        |
| LED 3  | NOT USED    | GREEN  | NOT USED        |
| LED 4  | NOT USED    | YELLOW | NOT USED        |
| LED 5  | NOT USED    | YELLOW | NOT USED        |
| LED 6  | NOT USED    | YELLOW | NOT USED        |
| LED 7  | NOT USED    | GREEN  | NOT USED        |
| LED 8  | CN 12 PIN 3 | GREEN  | SYSTEM PRESS SW |
| LED 9  | NOT USED    | GREEN  | NOT USED        |
| LED 10 | NOT USED    | GREEN  | NOT USED        |
| LED 11 | NOT USED    | YELLOW | NOT USED        |
| LED 12 | NOT USED    | YELLOW | NOT USED        |
| LED 13 | NOT USED    | YELLOW | NOT USED        |
| LED 14 | NOT USED    | YELLOW | NOT USED        |

| LED #  | CONNECTOR | COLOR | DESCRIPTION |
|--------|-----------|-------|-------------|
| LED 15 | NOT USED  | GREEN | NOT USED    |
| LED 16 | NOT USED  | GREEN | NOT USED    |
| LED 17 | NOT USED  | GREEN | NOT USED    |
| LED 18 | NOT USED  | GREEN | NOT USED    |
| LED 19 | NOT USED  | RED   | SW BATT OUT |
| LED 20 | NOT USED  | RED   | SW BATT IN  |
| LED 21 | NOT USED  | RED   | NOT USED    |
| LED 22 | NOT USED  | RED   | NOT USED    |
| LED 23 | NOT USED  | RED   | NOT USED    |
| LED 24 | NOT USED  | RED   | NOT USED    |
| LED 25 | ---       | ---   | ---         |
| LED 26 | ---       | ---   | ---         |
| LED 27 | ---       | ---   | ---         |
| LED 28 | ---       | ---   | ---         |

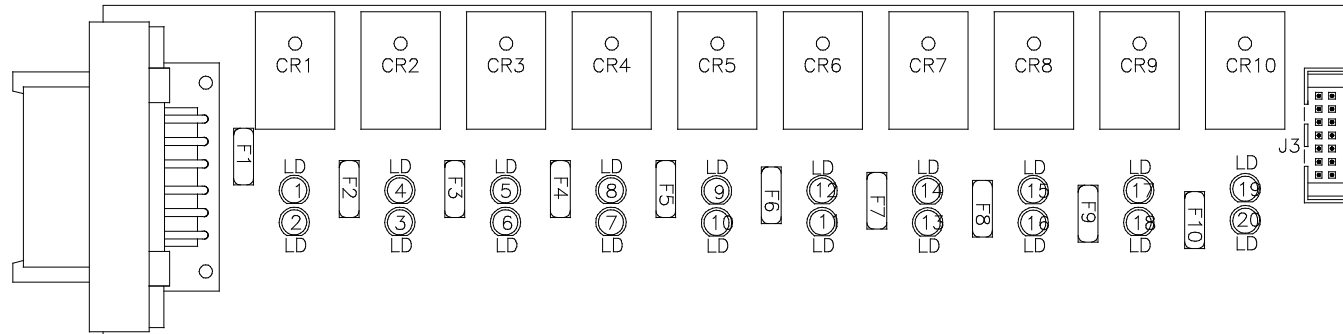

REAR AIR  
OUTPUT  
LED LAYOUT

| LED # | COLOR  | INPUT J3 | FUSE #  | OUTPUT | RELAY # | DESCRIPTION                    |
|-------|--------|----------|---------|--------|---------|--------------------------------|
| LED1  | YELLOW | PIN 13   | ---     | ---    | CR1     | TAG LIFT (COIL)                |
| LED2  | RED    | ---      | FUSE 1  | PIN 1  | CR1     | TAG LIFT (CONTACT)             |
| LED3  | RED    | ---      | FUSE 2  | PIN 2  | CR2     | LEFT REAR RAISE (CONTACT)      |
| LED4  | YELLOW | PIN 12   | ---     | ---    | CR2     | LEFT REAR RAISE (COIL)         |
| LED5  | YELLOW | PIN 11   | ---     | ---    | CR3     | LEFT REAR LOWER (COIL)         |
| LED6  | RED    | ---      | FUSE 3  | PIN 3  | CR3     | LEFT REAR LOWER (CONTACT)      |
| LED7  | RED    | ---      | FUSE 4  | PIN 4  | CR4     | RIGHT REAR RAISE (CONTACT)     |
| LED8  | YELLOW | PIN 10   | ---     | ---    | CR4     | RIGHT REAR RAISE (COIL)        |
| LED9  | YELLOW | PIN 9    | ---     | ---    | CR5     | RIGHT REAR LOWER (COIL)        |
| LED10 | RED    | ---      | FUSE 5  | PIN 5  | CR5     | RIGHT REAR LOWER (CONTACT)     |
| LED11 | RED    | ---      | FUSE 6  | PIN 6  | CR6     | NOT USED                       |
| LED12 | YELLOW | PIN 8    | ---     | ---    | CR6     | NOT USED                       |
| LED13 | RED    | ---      | FUSE 7  | PIN 10 | CR7     | TAG LEFT REAR LOWER (CONTACT)  |
| LED14 | YELLOW | PIN 7    | ---     | ---    | CR7     | TAG LEFT REAR LOWER (COIL)     |
| LED15 | YELLOW | PIN 6    | ---     | ---    | CR8     | TAG RIGHT REAR LOWER (COIL)    |
| LED16 | RED    | ---      | FUSE 8  | PIN 9  | CR8     | TAG RIGHT REAR LOWER (CONTACT) |
| LED17 | YELLOW | PIN 5    | ---     | ---    | CR9     | TAG TRAVEL (COIL)              |
| LED18 | RED    | ---      | FUSE 9  | PIN 7  | CR9     | TAG TRAVEL (CONTACT)           |
| LED19 | YELLOW | PIN 4    | ---     | ---    | CR10    | TRAVEL (COIL)                  |
| LED20 | RED    | ---      | FUSE 10 | PIN 8  | CR10    | TRAVEL (CONTACT)               |

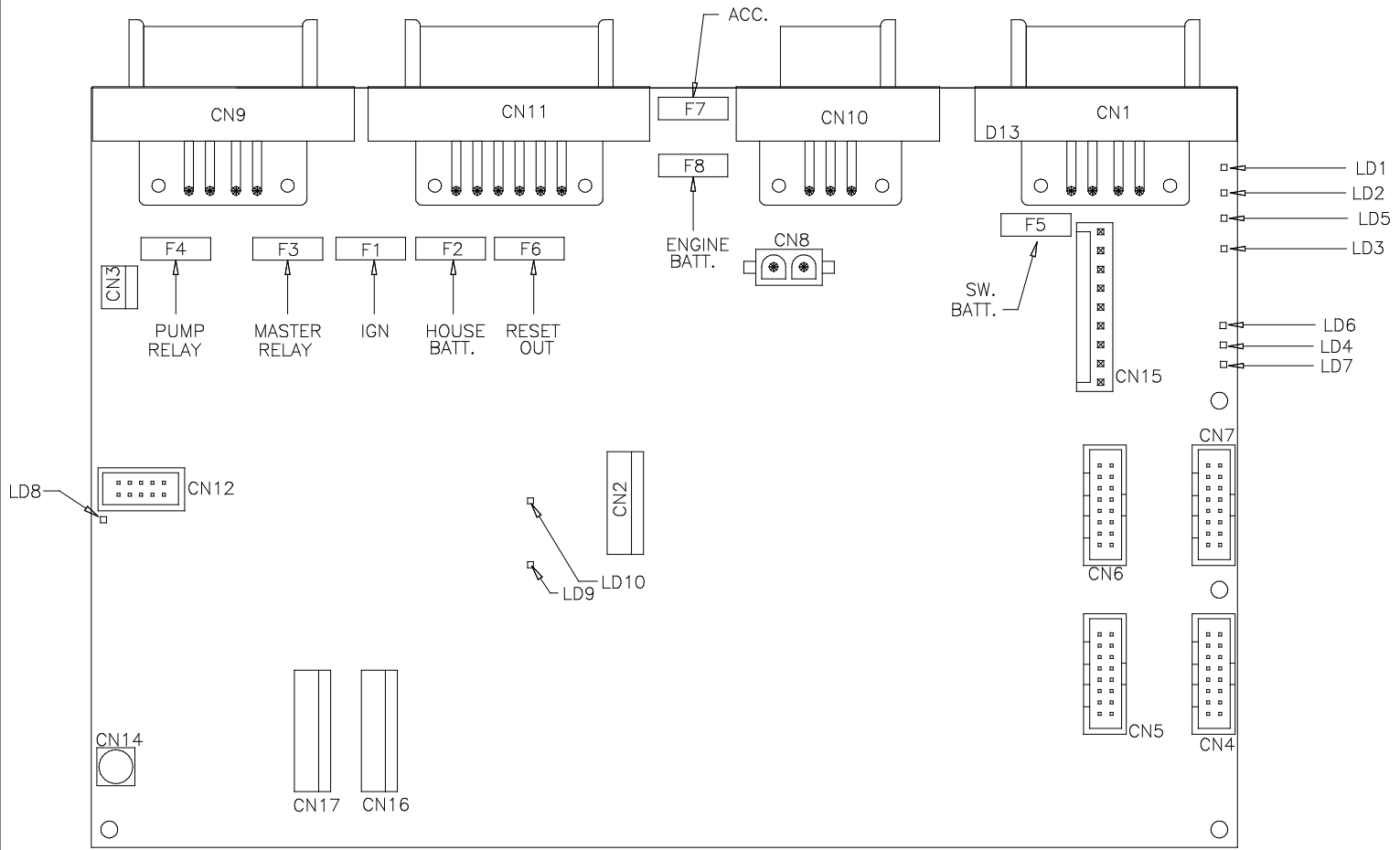

CENTRAL CONTROL MODULE LED LAYOUT

| LED #  | CONNECTOR       | COLOR    | DESCRIPTION   |
|--------|-----------------|----------|---------------|
| LED 1  | CN 9 PIN 1      | RED      | MASTER RELAY  |
| LED 2  | CN 9 PIN 4      | RED      | PUMP RELAY    |
| LED 3  | CN 1 PIN 3      | RED      | SW 12V        |
| LED 4  | CN 11 PIN 12    | RED      | ENGINE BATT   |
| LED 5  | CN 9 PIN 5      | RED      | SPEED SWITCH  |
| LED 6  | NOT USED        | NOT USED | NOT USED      |
| LED 7  | CN 1 PIN 7 & 8  | RED      | LINK LIGHT    |
| LED 8  | CN 11 PIN 8 & 9 | RED      | NEUTRAL HOLD  |
| LED 9  | NOT USED        | NOT USED | NOT USED      |
| LED 10 | CN9 PIN 2       | RED      | 3000 LBS. PSW |

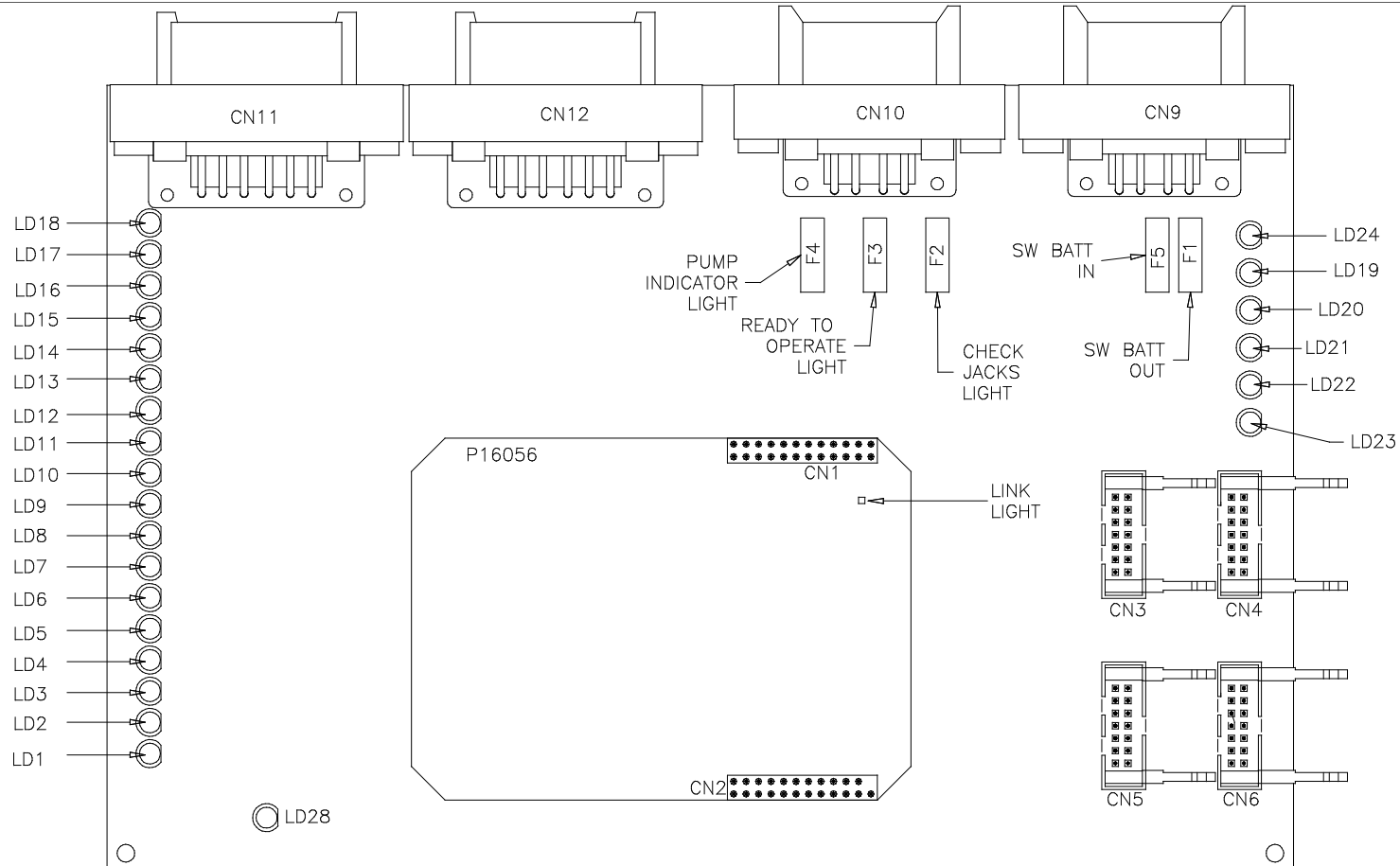

ROOM 1  
LED LAYOUT

| LED #  | CONNECTOR    | COLOR  | DESCRIPTION  | LED #  | CONNECTOR       | COLOR | DESCRIPTION      |
|--------|--------------|--------|--------------|--------|-----------------|-------|------------------|
| LED 1  | CN 10 PIN 4  | RED    | EXTEND       | LED 15 | CN 11 PIN 4     | GREEN | LR LOCK          |
| LED 2  | CN 10 PIN 5  | RED    | RETRACT      | LED 16 | CN 12 PIN 4     | GREEN | LF LOCK          |
| LED 3  | NOT USED     | GREEN  | NOT USED     | LED 17 | CN 11 PIN 9     | GREEN | UR LOCK          |
| LED 4  | NOT USED     | YELLOW | NOT USED     | LED 18 | CN 12 PIN 9     | GREEN | UF LOCK          |
| LED 5  | NOT USED     | YELLOW | NOT USED     | LED 19 | CN11/CN12 PIN 7 | RED   | SW 12V           |
| LED 6  | CN 12 PIN 2  | YELLOW | FRONT RM OUT | LED 20 | CN9 PIN 3       | RED   | SW BATT          |
| LED 7  | NOT USED     | GREEN  | NOT USED     | LED 21 | CN10 PIN 3      | RED   | PUMP INDICATOR   |
| LED 8  | NOT USED     | GREEN  | NOT USED     | LED 22 | CN10 PIN 2      | RED   | READY TO OPERATE |
| LED 9  | CN 11 PIN 10 | GREEN  | UR ROOM IN   | LED 23 | NOT USED        | RED   | NOT USED         |
| LED 10 | CN 12 PIN 10 | GREEN  | UF ROOM IN   | LED 24 | CN 10 PIN 7     | RED   | SYSTEM WAKE UP   |
| LED 11 | CN 11 PIN 1  | YELLOW | LR UNLOCK    | LED 25 | ---             | ---   | ---              |
| LED 12 | CN 12 PIN 1  | YELLOW | LF UNLOCK    | LED 26 | ---             | ---   | ---              |
| LED 13 | CN11 PIN 12  | YELLOW | UR UNLOCK    | LED 27 | ---             | ---   | ---              |
| LED 14 | CN 12 PIN 12 | YELLOW | UF UNLOCK    | LED 28 | CN 12 PIN 11    | RED   | SYNC CYL PSW     |

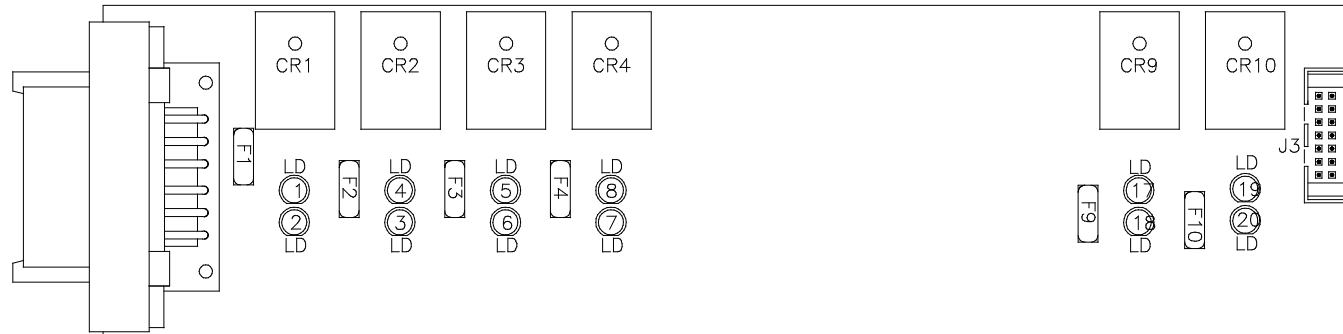

ROOM  
LED LAYOUT

| LED # | COLOR  | INPUT J3 | FUSE #  | OUTPUT | RELAY # | DESCRIPTION             |
|-------|--------|----------|---------|--------|---------|-------------------------|
| LED1  | YELLOW | PIN 13   | ---     | ---    | CR1     | CYL EXTEND 1 (COIL)     |
| LED2  | RED    | ---      | FUSE 1  | PIN 1  | CR1     | CYL EXTEND 1 (CONTACT)  |
| LED3  | RED    | ---      | FUSE 2  | PIN 2  | CR2     | CYL RETRACT1 (CONTACT)  |
| LED4  | YELLOW | PIN 12   | ---     | ---    | CR2     | CYL RETRACT RM 1 (COIL) |
| LED5  | YELLOW | PIN 11   | ---     | ---    | CR3     | LOCK RM 1 (COIL)        |
| LED6  | RED    | ---      | FUSE 3  | PIN 3  | CR3     | LOCK RM 1 (CONTACT)     |
| LED7  | RED    | ---      | FUSE 4  | PIN 4  | CR4     | UNLOCK RM 1 (CONTACT)   |
| LED8  | YELLOW | PIN 10   | ---     | ---    | CR4     | UNLOCK RM 1 (COIL)      |
| LED9  | ---    | ---      | ---     | ---    | ---     | ---                     |
| LED10 | ---    | ---      | ---     | ---    | ---     | ---                     |
| LED11 | ---    | ---      | ---     | ---    | ---     | ---                     |
| LED12 | ---    | ---      | ---     | ---    | ---     | ---                     |
| LED13 | ---    | ---      | ---     | ---    | ---     | ---                     |
| LED14 | ---    | ---      | ---     | ---    | ---     | ---                     |
| LED15 | ---    | ---      | ---     | ---    | ---     | ---                     |
| LED16 | ---    | ---      | ---     | ---    | ---     | ---                     |
| LED17 | YELLOW | PIN 5    | ---     | ---    | CR9     | AIR SEAL (COIL)         |
| LED18 | RED    | ---      | FUSE 9  | PIN 7  | CR9     | AIR SEAL (CONTACT)      |
| LED19 | YELLOW | PIN 4    | ---     | ---    | CR10    | NOT USED                |
| LED20 | RED    | ---      | FUSE 10 | PIN 8  | CR10    | NOT USED                |