

AP43840
CONTROL BOX

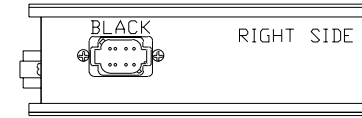
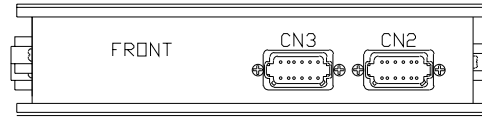
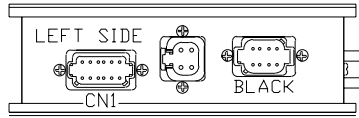

CN1<BROWN>
PIN

- 1 BLK<W1400> LEFT FRONT EXTEND
- 2 BLK<W1500> LEFT FRONT RETRACT
- 3 BLK<W2400> RIGHT FRONT EXTEND
- 4 BLK<W2500> RIGHT FRONT RETRACT
- 5 BLK<W4400> LEFT REAR EXTEND
- 6 BLK<W4500> LEFT REAR RETRACT
- 7 BLK<W3400> RIGHT REAR EXTEND
- 8 BLK<W3500> RIGHT REAR RETRACT
- 9 BLK<W8500> MASTER RELAY CONTROL
- 10 BLK<W8600> PUMP RELAY CONTROL
- 11 N/C
- 12 N/C

4 PIN GRAY
PIN

- 1 BLK<W6800> SW. BATTERY
- 2 BLK<W6800> SW. BATTERY
- 3 WHT<W6230> GROUND
- 4 WHT<W6230> GROUND

8 PIN BLACK <LEFT SIDE>
PIN

- 1 N/C
- 2 N/C
- 3 N/C
- 4 N/C
- 5 N/C
- 6 N/C
- 7 BLACK 120 Ω RESISTOR
- 8 BLACK 120 Ω RESISTOR

AP42640 CN3<BLACK>
PIN

- 1 BLK<W1000> LEFT FRONT WARN. SW.
- 2 BLK<W1200> LEFT FRONT PRESS. SW.
- 3 BLK<W2000> RIGHT FRONT WARN. SW.
- 4 BLK<W2200> RIGHT FRONT PRESS. SW.
- 5 BLK<W8100> SYSTEM PRESS. SW.
- 6 WHT<W6235> GROUND
- 7 N/C
- 8 N/C
- 9 BLK<W4000> LEFT REAR WARN. SW.
- 10 BLK<W4200> LEFT REAR PRESS. SW.
- 11 BLK<W3000> RIGHT REAR WARN. SW.
- 12 BLK<W3200> RIGHT REAR PRESS. SW.

AP42640 CN2<BROWN>
PIN

- 1 N/C <KEY PIN>
- 2 N/C
- 3 N/C
- 4 N/C
- 5 N/C
- 6 <WHITE> GROUND
- 7 <RED> +12V
- 8 N/C
- 9 <YELLOW> LEFT SIDE SENSE
- 10 <BLACK> FRONT SENSE
- 11 <GREEN> RIGHT SIDE SENSE
- 12 <ORANGE> REAR SENSE

8 PIN BLACK <RIGHT SIDE>
PIN

- 1 N/C
- 2 N/C
- 3 BLK<W6800> SWITCHED BATT.
- 4 WHT<W6230> GROUND
- 5 CAN SHIELD
- 6 N/C
- 7 <GREEN> CAN LOW
- 8 <YELLOW> CAN HI

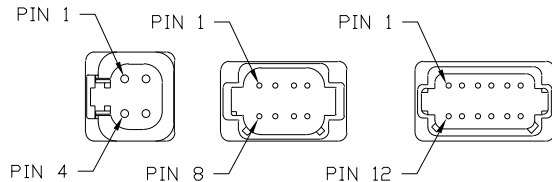

NOTE: DEUTSCH PIN NUMBERS TYPICAL UNLESS OTHERWISE NOTED

NOTE: INSTALLATION MUST CONFORM TO GOOD SHOP PRACTICES, SAE STANDARDS, RVIA STANDARDS, AND OTHER APPLICABLE STANDARDS.

		HWH		I-80 EXIT 267 SOUTH RT 1 MOSCOW, IOWA 52760	
		SCALE 1:3	DATE 21JUN10	DRAWN BY .	
		SYSTEM SCHEMATIC ELEC			
NO.	DATE	REVISION			
THE INFORMATION DISCLOSED ON THIS DRAWING IS CONFIDENTIAL AND MUST NOT BE DISCLOSED OR USED IN ANY MANNER WHICH WILL BE DETRIMENTAL TO THE HWH CORPORATION				DRAWING NUMBER MP90491 A/F	

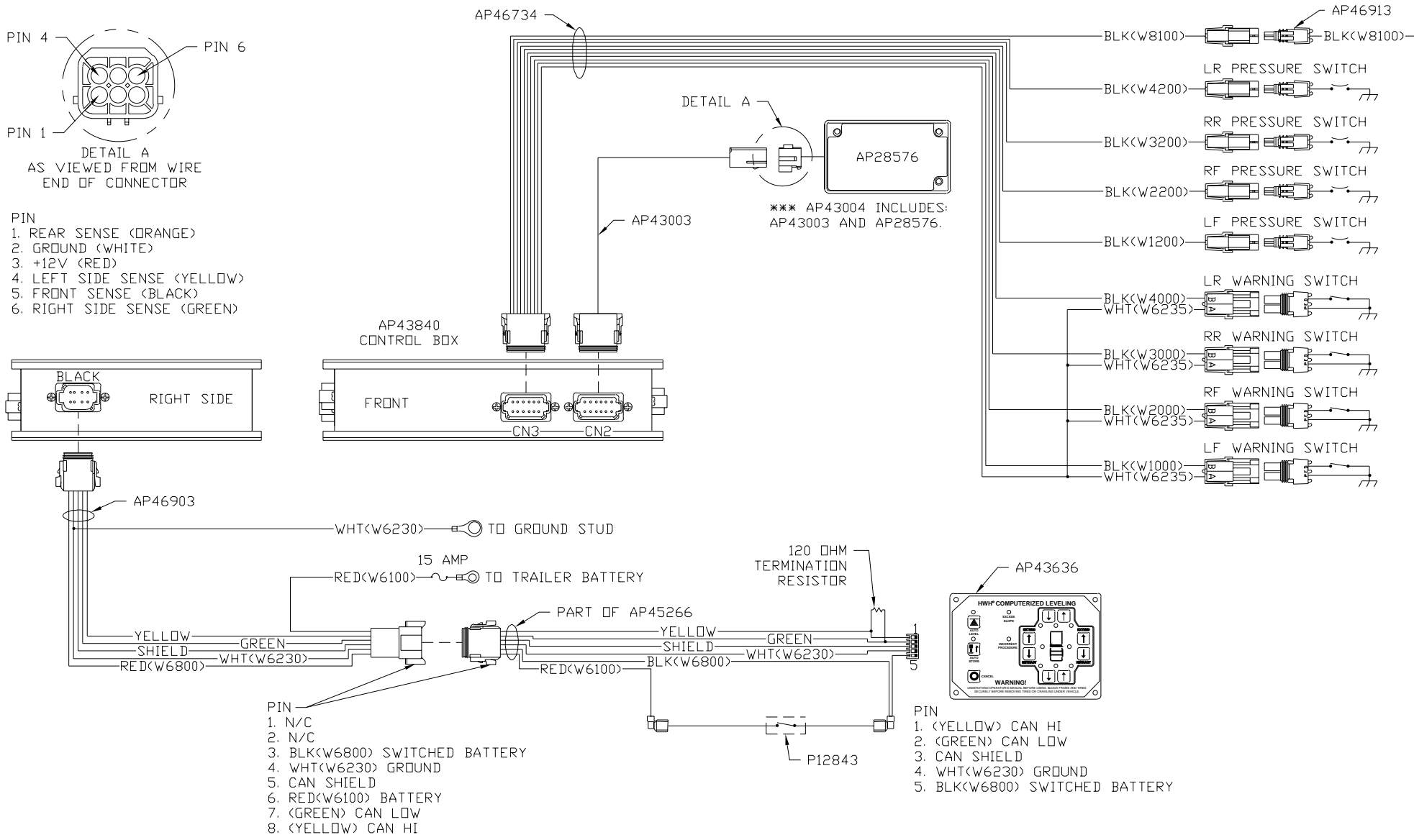

NOTE: INSTALLATION MUST CONFORM TO GOOD SHOP PRACTICES, SAE STANDARDS, RVIA STANDARDS, AND OTHER APPLICABLE STANDARDS.

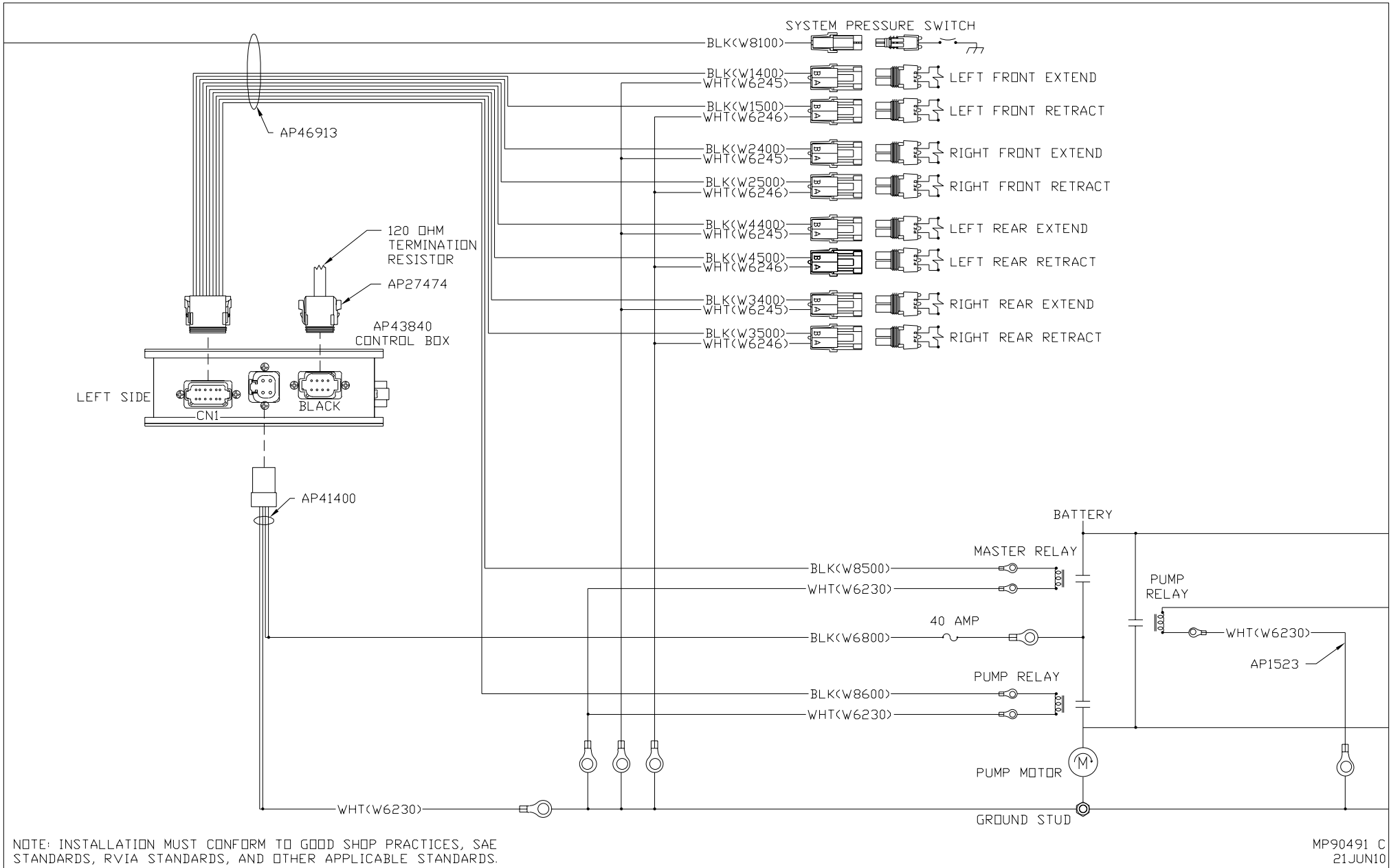

NOTE: INSTALLATION MUST CONFORM TO GOOD SHOP PRACTICES, SAE STANDARDS, RVIA STANDARDS, AND OTHER APPLICABLE STANDARDS.

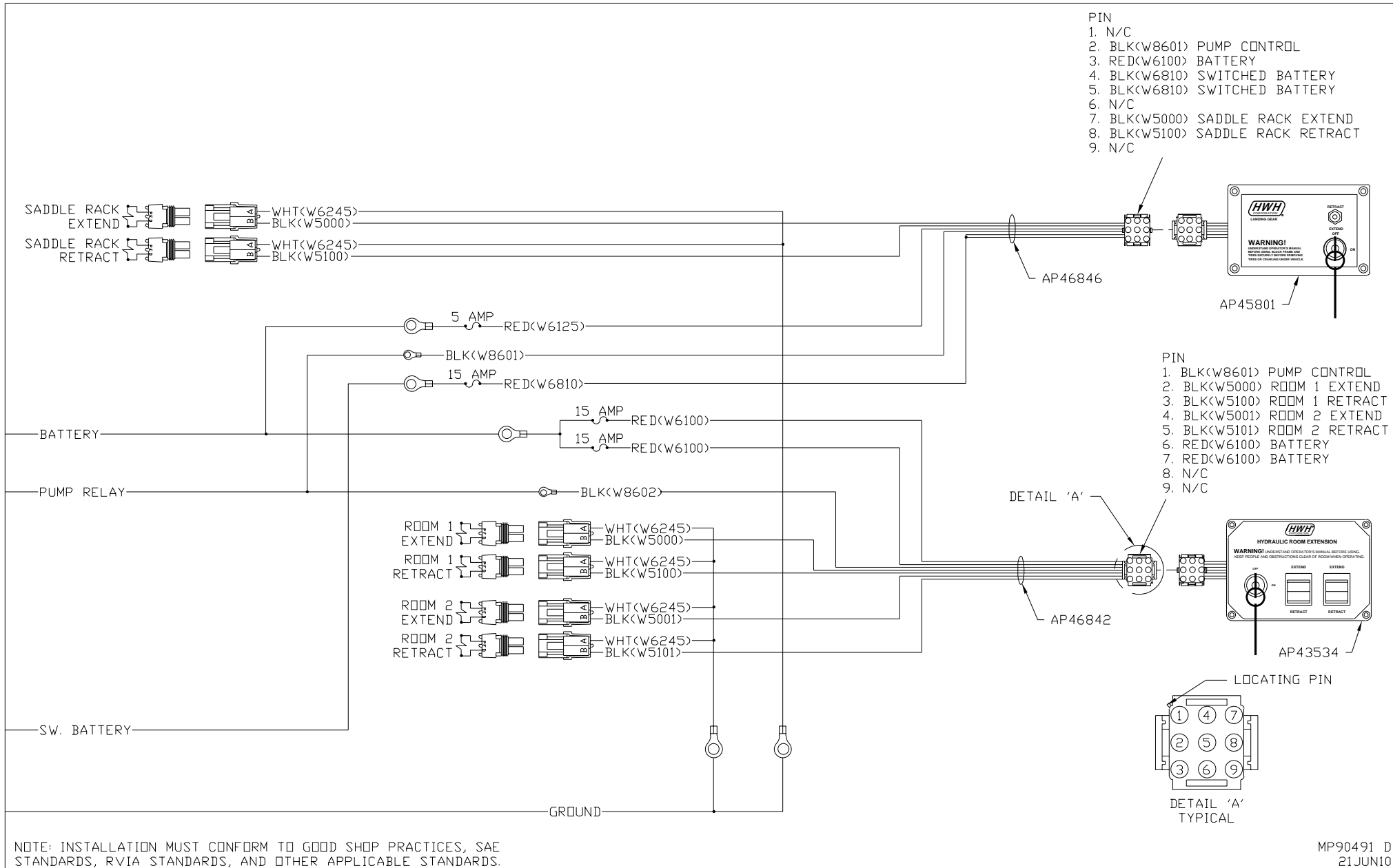

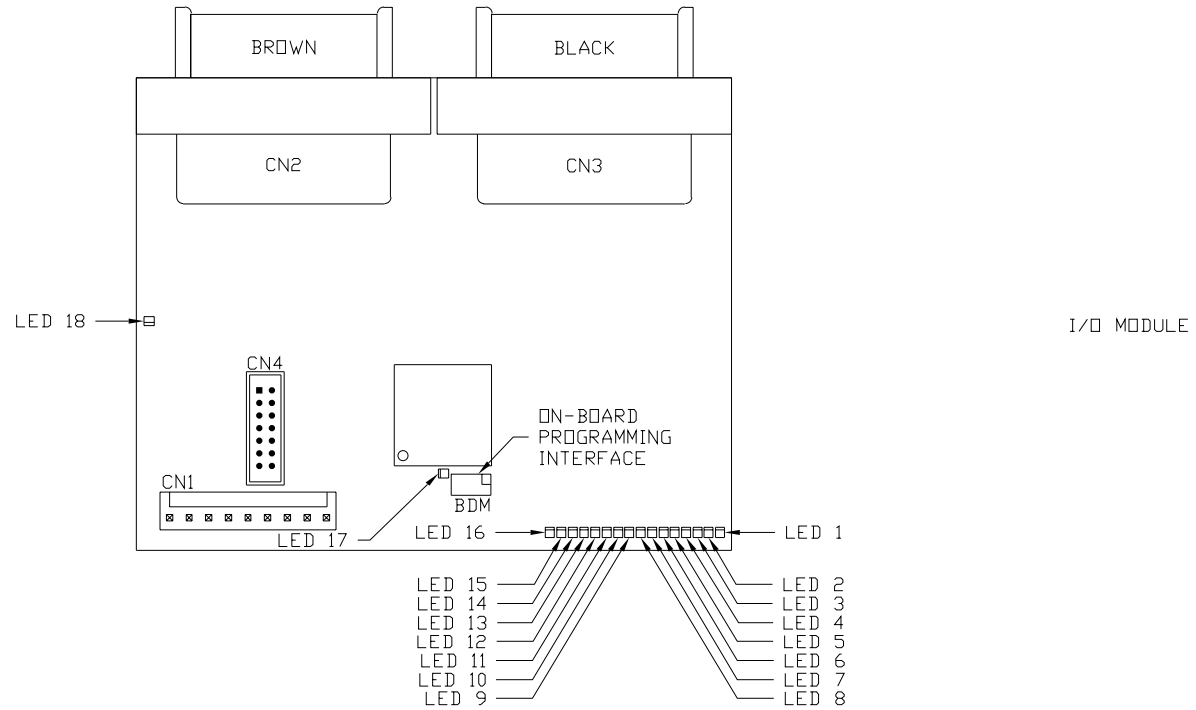

LED #	CONNECTOR	COLOR	DESCRIPTION
LED 1	CN3 PIN 1	RED	LEFT FRONT WARN. SW.
LED 2	CN3 PIN 2	GREEN	LEFT FRONT PRESS. SW.
LED 3	CN3 PIN 3	YELLOW	RIGHT FRONT WARN. SW.
LED 4	CN3 PIN 4	RED	RIGHT FRONT PRESS. SW.
LED 5	CN3 PIN 5	GREEN	SYSTEM PRESS. SW.
LED 6	NOT USED	YELLOW	NOT USED
LED 7	NOT USED	RED	NOT USED
LED 8	NOT USED	GREEN	NOT USED
LED 9	CN3 PIN 9	YELLOW	LEFT REAR WARN. SW.

LED #	CONNECTOR	COLOR	DESCRIPTION
LED 10	CN3 PIN 10	RED	LEFT REAR PRESS. SW.
LED 11	CN3 PIN 11	GREEN	RIGHT REAR WARN. SW.
LED 12	CN3 PIN 12	YELLOW	RIGHT REAR PRESS. SW.
LED 13	CN2 PIN 9	RED	LEFT SIDE SENSE
LED 14	CN2 PIN 10	GREEN	FRONT SENSE
LED 15	CN2 PIN 11	YELLOW	RIGHT SIDE SENSE
LED 16	CN2 PIN 12	RED	REAR SENSE
LED 17	NOT APPLICABLE	RED	LINK LIGHT
LED 18	NOT APPLICABLE	RED	POWER TO CAN MODULES

NOTE: INSTALLATION MUST CONFORM TO GOOD SHOP PRACTICES, SAE STANDARDS, RVIA STANDARDS, AND OTHER APPLICABLE STANDARDS.

MP90491 E
21JUN10

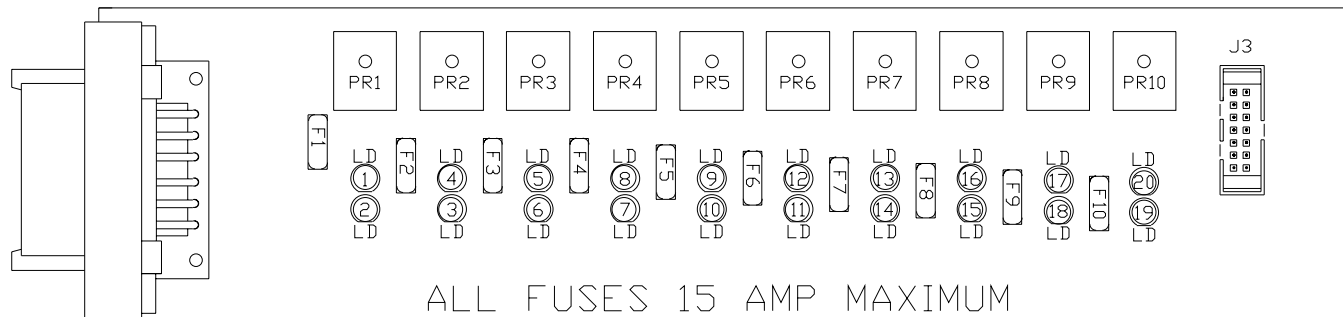

OUTPUTS
LED LAYOUT

LED #	COLOR	FUSE #	OUTPUT	RELAY #	DESCRIPTION
LED1	YELLOW	---	---	PR1	LEFT FRONT EXTEND <COIL>
LED2	RED	FUSE 1	PIN 1	PR1	LEFT FRONT EXTEND <CONTACT>
LED3	RED	FUSE 2	PIN 2	PR2	LEFT FRONT RETRACT <CONTACT>
LED4	YELLOW	---	---	PR2	LEFT FRONT RETRACT <COIL>
LED5	YELLOW	---	---	PR3	RIGHT FRONT EXTEND <COIL>
LED6	RED	FUSE 3	PIN 3	PR3	RIGHT FRONT EXTEND <CONTACT>
LED7	RED	FUSE 4	PIN 4	PR4	RIGHT FRONT RETRACT <CONTACT>
LED8	YELLOW	---	---	PR4	RIGHT FRONT RETRACT <COIL>
LED9	YELLOW	---	---	PR5	LEFT REAR EXTEND <COIL>
LED10	RED	FUSE 5	PIN 5	PR5	LEFT REAR EXTEND <CONTACT>
LED11	RED	FUSE 6	PIN 6	PR6	LEFT REAR RETRACT <CONTACT>
LED12	YELLOW	---	---	PR6	LEFT REAR RETRACT <COIL>
LED13	YELLOW	---	---	PR7	RIGHT REAR EXTEND <COIL>
LED14	RED	FUSE 7	PIN 7	PR7	RIGHT REAR EXTEND <CONTACT>
LED15	RED	FUSE 8	PIN 8	PR8	RIGHT REAR RETRACT <CONTACT>
LED16	YELLOW	---	---	PR8	RIGHT REAR RETRACT <COIL>
LED17	YELLOW	---	---	PR9	MASTER RELAY CONTROL <COIL>
LED18	RED	FUSE 9	PIN 9	PR9	MASTER RELAY CONTACT <CONTACT>
LED19	RED	FUSE 10	PIN 10	PR10	PUMP RELAY CONTACT <CONTACT>
LED20	YELLOW	---	---	PR10	PUMP RELAY CONTROL <COIL>

NOTE: INSTALLATION MUST CONFORM TO GOOD SHOP PRACTICES, SAE STANDARDS, RVIA STANDARDS, AND OTHER APPLICABLE STANDARDS.