

AP42581
FRONT ACTIVE AIR INPUT/OUTPUT MODULE

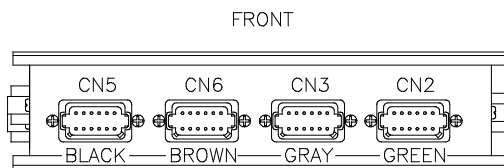
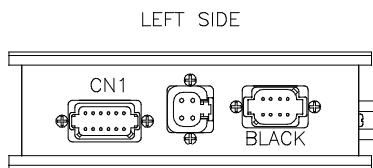

AP38815 CN1 (BROWN)

- PIN
- 1 BLK(W1500) LEFT FRONT RAISE
 - 2 BLK(W1600) LEFT FRONT LOWER
 - 3 BLK(W2500) RIGHT FRONT RAISE
 - 4 BLK(W2600) RIGHT FRONT LOWER
 - 5 BLK(W9700) COMPRESSOR
 - 6 N/C
 - 7 N/C
 - 8 N/C
 - 9 N/C
 - 10 N/C
 - 11 WHT(W6254) GROUND
 - 12 N/C

AP38815 (GRAY)

- PIN
- 1 RED(W6800) SW BATT
 - 2 RED(W6800) SW BATT
 - 3 GRN(W6230) GND
 - 4 GRN(W6230) GND

AP38815 RIGHT SIDE (BLACK)

- PIN
- 1 N/C
 - 2 N/C
 - 3 RED(W6800) SW BATTERY
 - 4 GRN(W6230) GROUND
 - 5 CAN SHIELD
 - 6 N/C
 - 7 GRN CAN LOW
 - 8 YEL CAN HI

AP38815 LEFT SIDE (BLACK)

- PIN
- 1 WHT(W7696) SYSTEM WAKE UP
 - 2 N/C
 - 3 RED(W6800) SW BATTERY
 - 4 GRN(W6230) GROUND
 - 5 CAN SHIELD
 - 6 N/C
 - 7 GRN CAN LOW
 - 8 YEL CAN HI

AP38815 CN5 (BLACK)

- PIN
- 1 BLK(W5703) ROOM 1 ROOM IN
 - 2 BLK(W5701) ROOM 1 ROOM OUT
 - 3 BLK(W5651) ROOM 1 VACUUM SENSOR
 - 4 BLK(W5702) ROOM 4 ROOM IN
 - 5 BLK(W5700) ROOM 4 ROOM OUT
 - 6 WHT(W7501) EXTEND (ROOM 1 AND 4)
 - 7 WHT(W7502) RETRACT (ROOM 1 AND 4)
 - 8 BLK(W5652) ROOM 4 VACUUM SENSOR
 - 9 N/C
 - 10 N/C
 - 11 N/C
 - 12 N/C

AP38815 CN6 (BROWN)

- PIN
- 1 BLK(W6800) SW. +12V
 - 2 N/C
 - 3 N/C
 - 4 BLK(W7510) READY TO OPERATE
 - 5 BLK(W7530) PUMP
 - 6 WHT(W6236) GROUND
 - 7 BLK(W6805) SW BATTERY
 - 8 BLK(W7696) SYSTEM WAKE UP
 - 9 N/C
 - 10 N/C
 - 11 N/C
 - 12 N/C

AP38815 CN3 (GRAY)

- PIN
- 1 BLK(W1100) RIDE HEIGHT LOW
 - 2 BLK(W1101) RIDE HEIGHT MEDIUM
 - 3 BLK(W1102) RIDE HEIGHT HIGH
 - 4 BLK(W1103) ENCODE A
 - 5 BLK(W1104) ENCODE B
 - 6 N/C
 - 7 N/C
 - 8 BLK(W7400) STEERING A
 - 9 BLK(W7401) STEERING B
 - 10 BLK(W7521) TAG DUMP
 - 11 N/C
 - 12 BLK(W6806) ROOM SELECT

AP38815 CN2 (GREEN)

- PIN
- 1 RED(W6120) SW. BATT
 - 2 BLK(W6900) +5V OUTPUT
 - 3 BLK(W6901) +5V OUTPUT
 - 4 N/C
 - 5 N/C
 - 6 WHT(W6235) GROUND
 - 7 RED(W6121) SW. BATT
 - 8 N/C
 - 9 N/C
 - 10 N/C
 - 11 BLK(W2220) RIGHT FRONT TRANSDUCER
 - 12 BLK(W1220) LEFT FRONT TRANSDUCER

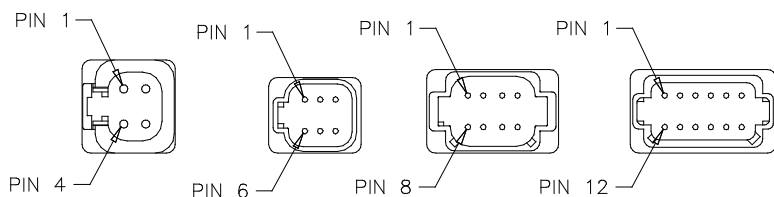

NOTE: DEUTSCH PIN NUMBERS TYPICAL UNLESS OTHERWISE NOTED

NOTE: INSTALLATION MUST CONFORM TO GOOD SHOP PRACTICES, SAE STANDARDS, RVIA STANDARDS, AND OTHER APPLICABLE STANDARDS.

		HWH		I-80 EXIT 267 SOUTH RT 1 MOSCOW, IOWA 52760	
		SCALE 1:3	DATE 10DEC10	DRAWN BY .	
15SEP11		WAS AP43584, AP43364		SYSTEM SCHEMATIC ELEC	
NO.	DATE	REVISION			
THE INFORMATION DISCLOSED ON THIS DRAWING IS CONFIDENTIAL AND MUST NOT BE DISCLOSED OR USED IN ANY MANNER WHICH WILL BE DETRIMENTAL TO THE HWH CORPORATION				DRAWING NUMBER MP90564 A/R	

AP45034
CENTRAL CONTROL
MODULES

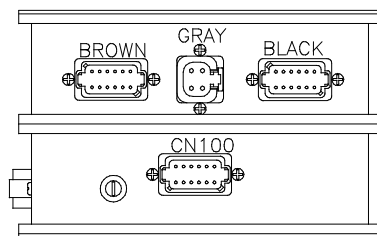
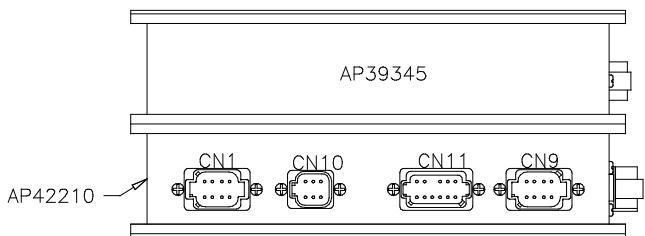

110 NEUTRAL HOLD ENABLED
220 NEUTRAL HOLD DISABLED

AP39345 (BROWN)

PIN	DESCRIPTION
1	BLK(W5050) CYLINDER EXTEND 1
2	BLK(W5150) CYLINDER RETRACT 1
3	BLK(W5600) AIR SEAL ROOM 1
4	BLK(W5650) VACUUM ROOM 1
5	BLK(W5053) CYLINDER EXTEND 4
6	BLK(W5153) CYLINDER RETRACT 4
7	BLK(W5603) AIR SEAL ROOM 4
8	BLK(W5653) VACCUM ROOM 4
9	BLK(W5054) CYLINDER EXTEND GEN
10	BLK(W5154) CYLINDER RETRACT GEN
11	WHT(W6230) GROUND
12	N/C

AP39345 (BLACK)

PIN	DESCRIPTION
1	BLK(W5051) CYLINDER EXTEND 2
2	BLK(W5151) CYLINDER RETRACT 2
3	BLK(W5602) AIR SEAL ROOM 2
4	BLK(W5652) VACUUM ROOM 2
5	BLK(W5052) CYLINDER EXTEND 3
6	BLK(W5152) CYLINDER RETRACT 3
7	BLK(W5603) AIR SEAL ROOM 3
8	BLK(W5653) VACUUM ROOM 3
9	N/C
10	N/C
11	WHT(W6231) GROUND
12	N/C

AP42210 CN100(GRAY)

PIN	DESCRIPTION
1	BLK(W5000) GEN SLIDE EXTEND
2	N/C
3	N/C
4	N/C
5	N/C
6	WHT(W6230) GROUND
7	N/C
8	N/C
9	N/C
10	N/C
11	N/C
12	BLK(W5100) GEN SLIDE RETRACT

AP39345 (GRAY)

PIN	DESCRIPTION
1	RED(W6800) SW BATT
2	RED(W6800) SW BATT
3	GRN(W6230) GROUND
4	GRN(W6230) GROUND

AP42210 CN1(BLACK)

PIN	DESCRIPTION
1	WHT(W7696) SYSTEM WAKE UP
2	N/C
3	RED(W6800) SW BATT
4	GRN(W6230) GND
5	CAN SHIELD
6	N/C
7	GRN CAN LOW
8	YEL CAN HI

AP42210 CN10(GRAY)

PIN	DESCRIPTION
1	BLK(W7599) SWITCH LIGHT CONTROL
2	RED(W6100) RESET OUT
3	BLK(W7550) RESET IN
4	RED(W6121) WARN LIGHT SUPPLY
5	WHT(W6230) SWITCH LIGHT SUPPLY
6	BLK(W7699) WARN LIGHT/BUZZER CONTROL

AP42210 CN11(GRAY)

PIN	DESCRIPTION
1	RED(W6110) IGNITION
2	N/C
3	N/C
4	N/C
5	RED(W6120) IGNITION
6	RED(W6100) HOUSE BATTERY
7	GRN(W6230) GROUND
8	WHT(W9961) NEUTRAL HOLD
9	WHT(W9955) NEUTRAL HOLD
10	N/C
11	WHT(W9000) PARK BRAKE SWITCH
12	RED(W6101) HOUSE BATTERY

AP42210 CN9(GREEN)

PIN	DESCRIPTION
1	BLK(W8500) MASTER RELAY CNTRL
2	BLK(W8100) SYSTEM PSW.
3	N/C
4	BLK(W8600) PMP RELAY CNTRL
5	BLK(W9900) SPEED SWITCH
6	BLK(W9901) SW BATT FROM PUMP RELAY
7	N/C
8	N/C

△
AP49030
REAR ACTIVE AIR INPUT/OUTPUT MODULE

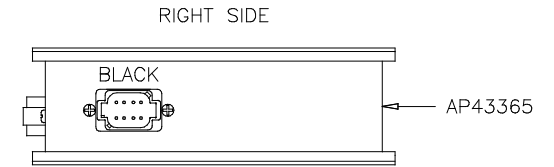
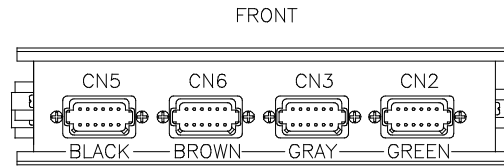
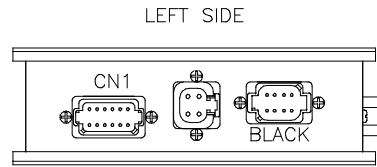

AP43365 CN1 BROWN
PIN

1	BLK(W4500)	LR RAISE
2	BLK(W4600)	LR LOWER
3	BLK(W4550)	LR HIGH VELOCITY RAISE
4	BLK(W4601)	LR TAG LOWER
5	BLK(W3500)	RR RAISE
6	BLK(W3600)	RR LOWER
7	BLK(W3550)	RR HIGH VELOCITY RAISE
8	BLK(W3601)	RR TAG LOWER
9	BLK(W4501)	LR TAG RAISE
10	BLK(W3501)	RR TAG RAISE
11	WHT(W6258)	GROUND
12	BLK(W3800)	TAG LIFT

AP43365 (GRAY)
PIN

1	RED (W6800)	SW BATT
2	RED (W6800)	SW BATT
3	GRN (W6230)	GND
4	GRN (W6230)	GND

AP43365 BLACK (LEFT SIDE)
PIN

1	WHT(W7696)	SYSTEM WAKE UP
2	N/C	
3	RED(W6800)	SW BATTERY
4	GRN(W6230)	GROUND
5	CAN SHIELD	
6	N/C	
7	GRN CAN LOW	
8	YEL CAN HI	

AP43365 BLACK (RIGHT SIDE)
PIN

1	N/C	
2	N/C	
3	N/C	
4	N/C	
5	N/C	
6	N/C	
7	BLACK 120 ?	RESISTOR
8	BLACK 120 ?	RESISTOR

AP43365 CN5(BLACK)
PIN

1	BLK(W3100)	RR RIDE HEIGHT LOW
2	BLK(W3101)	RR RIDE HEIGHT MEDIUM
3	BLK(W3102)	RR RIDE HEIGHT HIGH
4	BLK(W3103)	RR ENCODE A
5	BLK(W3104)	RR ENCODE B
6	BLK(W6806)	ROOM SELECT
7	N/C	
8	N/C	
9	N/C	
10	BLK(W5702)	ROOM 3 ROOM IN
11	BLK(W5700)	ROOM 3 ROOM OUT
12	BLK(W5652)	ROOM 3 VACUUM SENSOR

AP43365 CN6(BROWN)
PIN

1	RED(W6121)	SW. BATT.
2	BLK(W6908)	+5V OUTPUT
3	BLK(W6909)	+5V OUTPUT
4	N/C	
5	N/C	
6	WHT(W6232)	GROUND
7	RED(W6805)	SW BATTERY
8	N/C	
9	N/C	
10	BLK(W3225)	SYSTEM TRANSDUCER
11	BLK(W3221)	RR TAG TRANSDUCER
12	BLK(W3220)	RR TRANSDUCER

AP43365 CN3(GRAY)
PIN

1	BLK(W4100)	LR RIDE HEIGHT LOW
2	BLK(W4101)	LR RIDE HEIGHT MEDIUM
3	BLK(W4102)	LR RIDE HEIGHT HIGH
4	BLK(W4103)	LR ENCODE A
5	BLK(W4104)	LR ENCODE B
6	BLK(W7501)	EXTEND (ROOM 2 AND 3)
7	BLK(W7502)	RETRACT (ROOM 2 AND 3)
8	N/C	
9	N/C	
10	BLK(W5703)	ROOM 2 ROOM IN
11	BLK(W5701)	ROOM 2 ROOM OUT
12	BLK(W5651)	ROOM 2 VACUUM SENSOR

AP43365 CN2(GREEN)
PIN

1	RED(W6120)	SW. BATT
2	BLK(W6912)	+5V OUTPUT
3	BLK(W6913)	+5V OUTPUT
4	BLK(W7510)	READY TO OPERATE
5	BLK(W7530)	PUMP
6	WHT(W6233)	GROUND
7	BLK(W6800)	SW. +12V
8	WHT(W7696)	SYSTEM WAKE UP
9	N/C	
10	N/C	
11	BLK(W4221)	LR TAG TRANSDUCER
12	BLK(W4220)	LR TRANSDUCER

NOTE: INSTALLATION MUST CONFORM TO GOOD SHOP PRACTICES, SAE STANDARDS, RVIA STANDARDS, AND OTHER APPLICABLE STANDARDS.

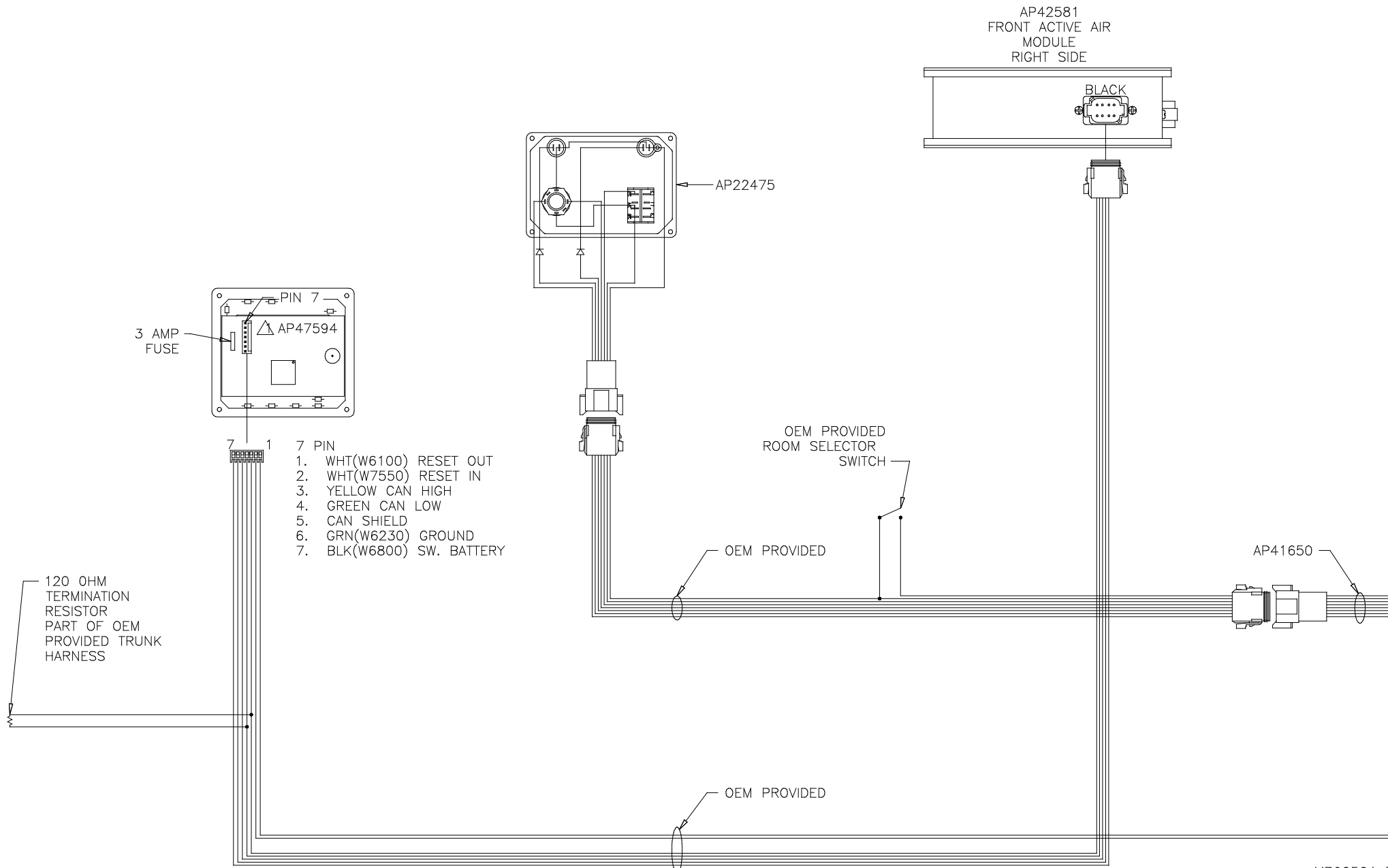

NOTE: INSTALLATION MUST CONFORM TO GOOD SHOP PRACTICES, SAE STANDARDS, RVIA STANDARDS, AND OTHER APPLICABLE STANDARDS.

AP42581
FRONT ACTIVE AIR MODULE
FRONT SIDE

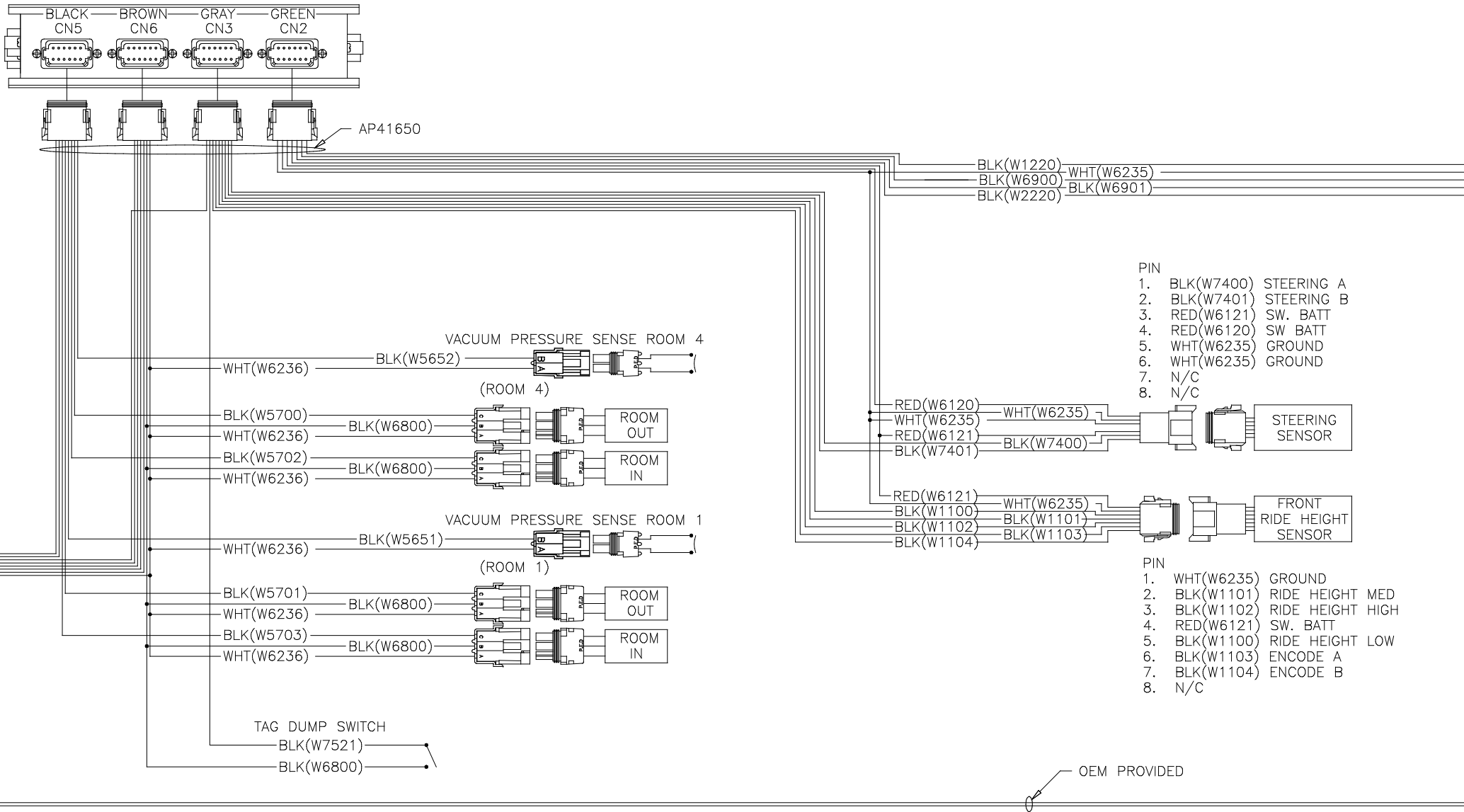

NOTE: INSTALLATION MUST CONFORM TO GOOD SHOP PRACTICES, SAE STANDARDS, RVIA STANDARDS, AND OTHER APPLICABLE STANDARDS.

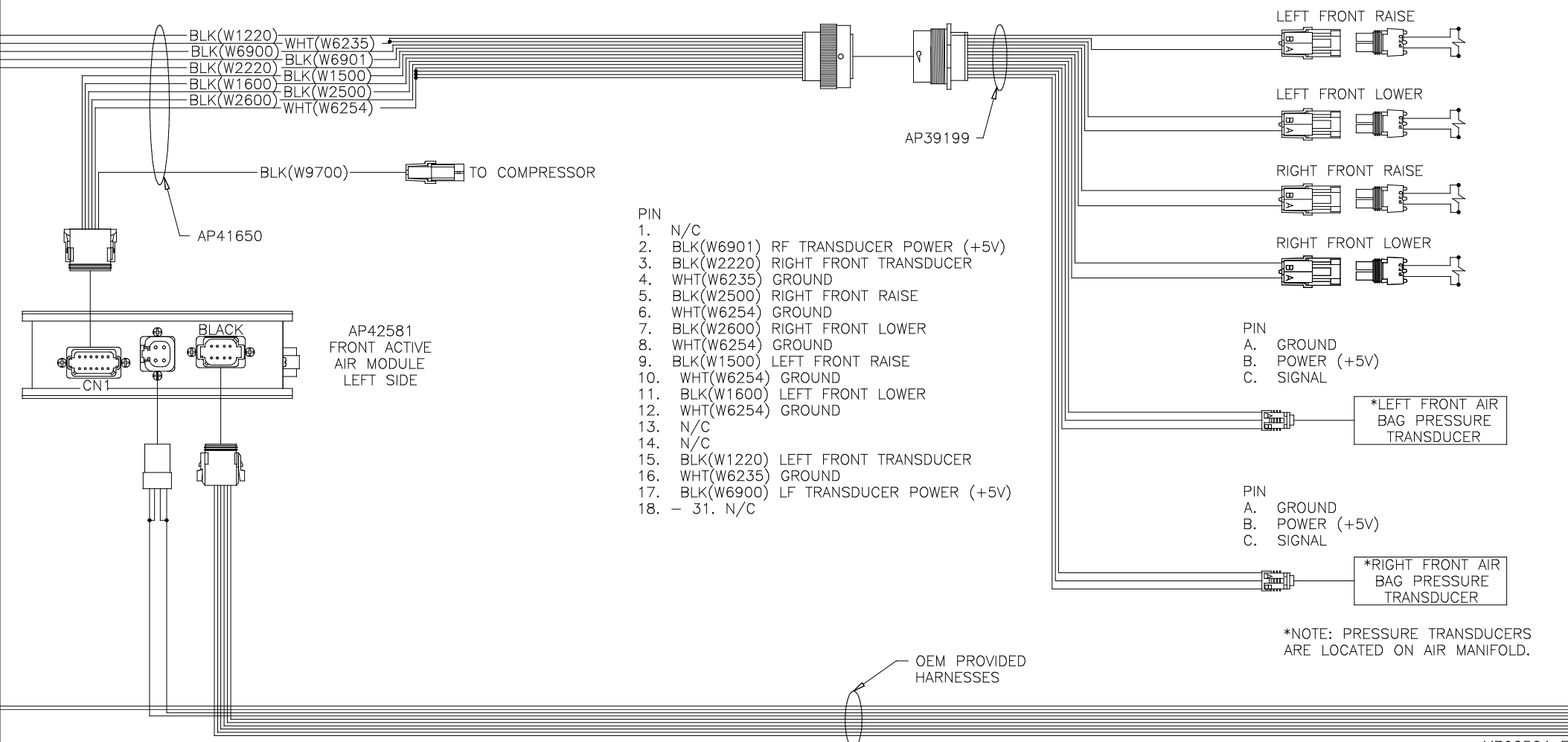

NOTE: INSTALLATION MUST CONFORM TO GOOD SHOP PRACTICES, SAE STANDARDS, RVIA STANDARDS, AND OTHER APPLICABLE STANDARDS.

- TO IGNITION — RED(W6110)
- TO IGNITION — RED(W6120)
- TO HOUSE BATTERY — RED(W6101)
- TO GROUND — GRN(W6230)
- TO PARK BRAKE — WHT(W9000)
- TO HOUSE BATTERY — RED(W6100)
- TO NEUTRAL HOLD — WHT(W9961)
- TO NEUTRAL HOLD — WHT(W9955)
- OEM PROVIDED

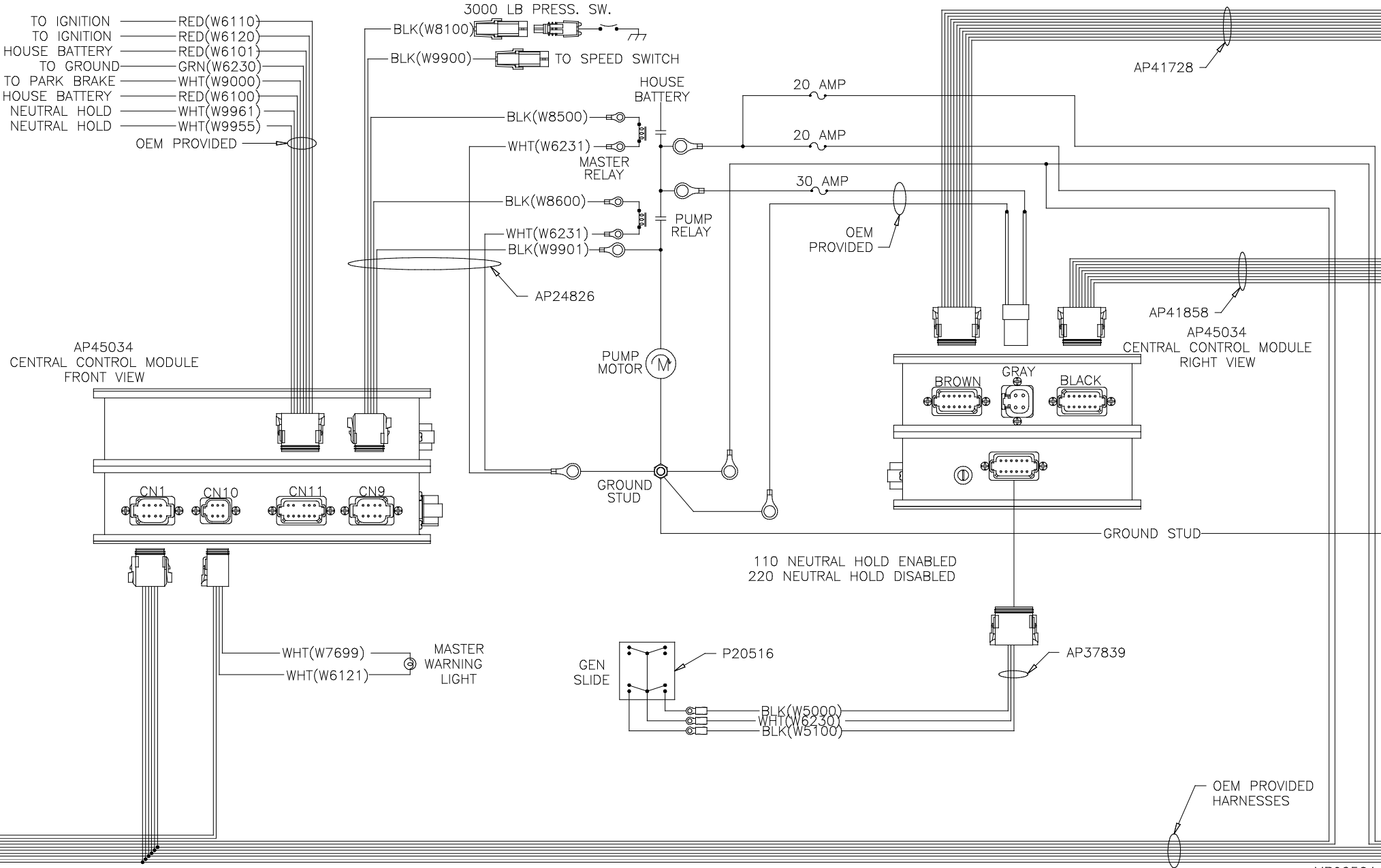

110 NEUTRAL HOLD ENABLED
220 NEUTRAL HOLD DISABLED

OEM PROVIDED HARNESSES

NOTE: INSTALLATION MUST CONFORM TO GOOD SHOP PRACTICES, SAE STANDARDS, RVIA STANDARDS, AND OTHER APPLICABLE STANDARDS.

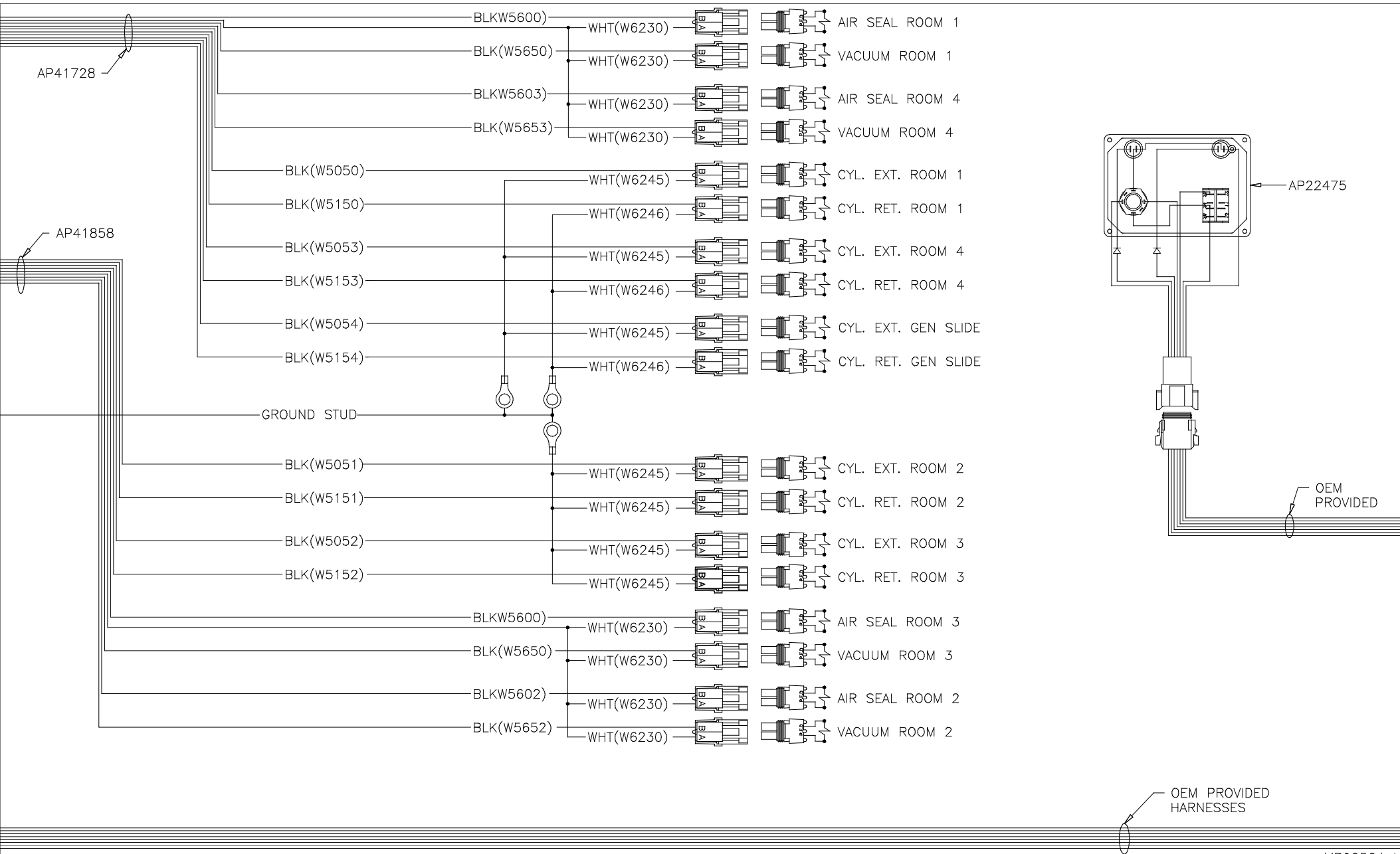

NOTE: INSTALLATION MUST CONFORM TO GOOD SHOP PRACTICES, SAE STANDARDS, RVIA STANDARDS, AND OTHER APPLICABLE STANDARDS.

AP49030
REAR ACTIVE AIR MODULE
FRONT SIDE

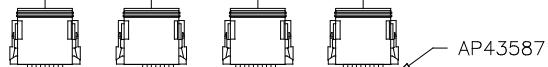
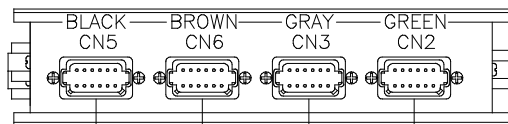

- BLK(W6913) — BLK(W3221)
- BLK(W4220) — BLK(W4221)
- BLK(W6912) — WHT(W6233)
- BLK(W3225) — BLK(W6909)
- WHT(W6232) — BLK(W6908)
- BLK(W3220)

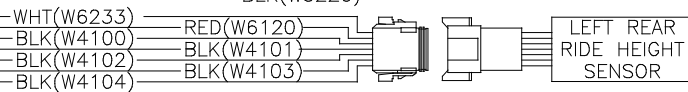

- PIN
- | | |
|-----------------------------------|---------------------------------|
| 1. WHT(W6233) GROUND | 5. BLK(4100) LR RIDE HEIGHT LOW |
| 2. BLK(W4101) LR RIDE HEIGHT MED | 6. BLK(4103) LR ENCODE A |
| 3. BLK(W4102) LR RIDE HEIGHT HIGH | 7. BLK(4104) LR ENCODE B |
| 4. RED(W6120) SW. BATT | 8. N/C |

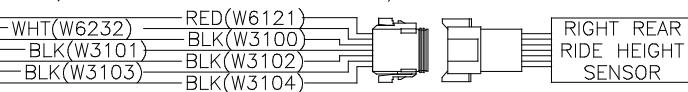

- PIN
- | | |
|----------------------------------|----------------------------------|
| 1. WHT(W6232) GROUND | 5. RED(W3100) RR RIDE HEIGHT LOW |
| 2. BLK(W3101) RR RIDE HEIGHT MED | 6. BLK(W3103) RR ENCODE A |
| 3. BLK(W3102) RR RIDE HEIGHT HI | 7. BLK(W3104) RR ENCODE B |
| 4. RED(W6121) SW. BATT | 8. N/C |

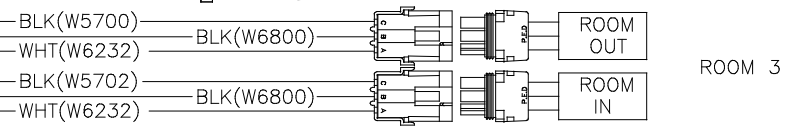
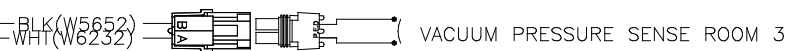
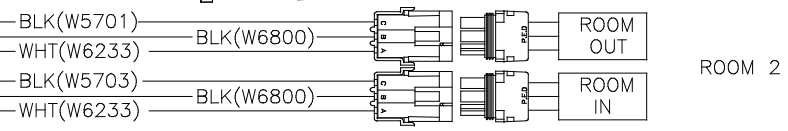
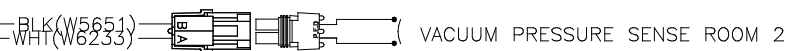

OEM PROVIDED ROOM SELECTOR SWITCH

OEM PROVIDED

- PIN
- | | | |
|---|------------|------------------|
| 1 | BLK(W6806) | ROOM SELECT |
| 2 | BLK(W7510) | READY TO OPERATE |
| 3 | BLK(W7530) | PUMP |
| 4 | WHT(W7501) | EXTEND |
| 5 | WHT(W7502) | RETRACT |
| 6 | BLK(W6805) | SW BATTERY |
| 7 | BLK(W7631) | SYS WAKE UP |
| 8 | WHT(W6230) | GROUND |

OEM PROVIDED HARNESSES

NOTE: INSTALLATION MUST CONFORM TO GOOD SHOP PRACTICES, SAE STANDARDS, RVIA STANDARDS, AND OTHER APPLICABLE STANDARDS.

MP90564 1
15SEP1

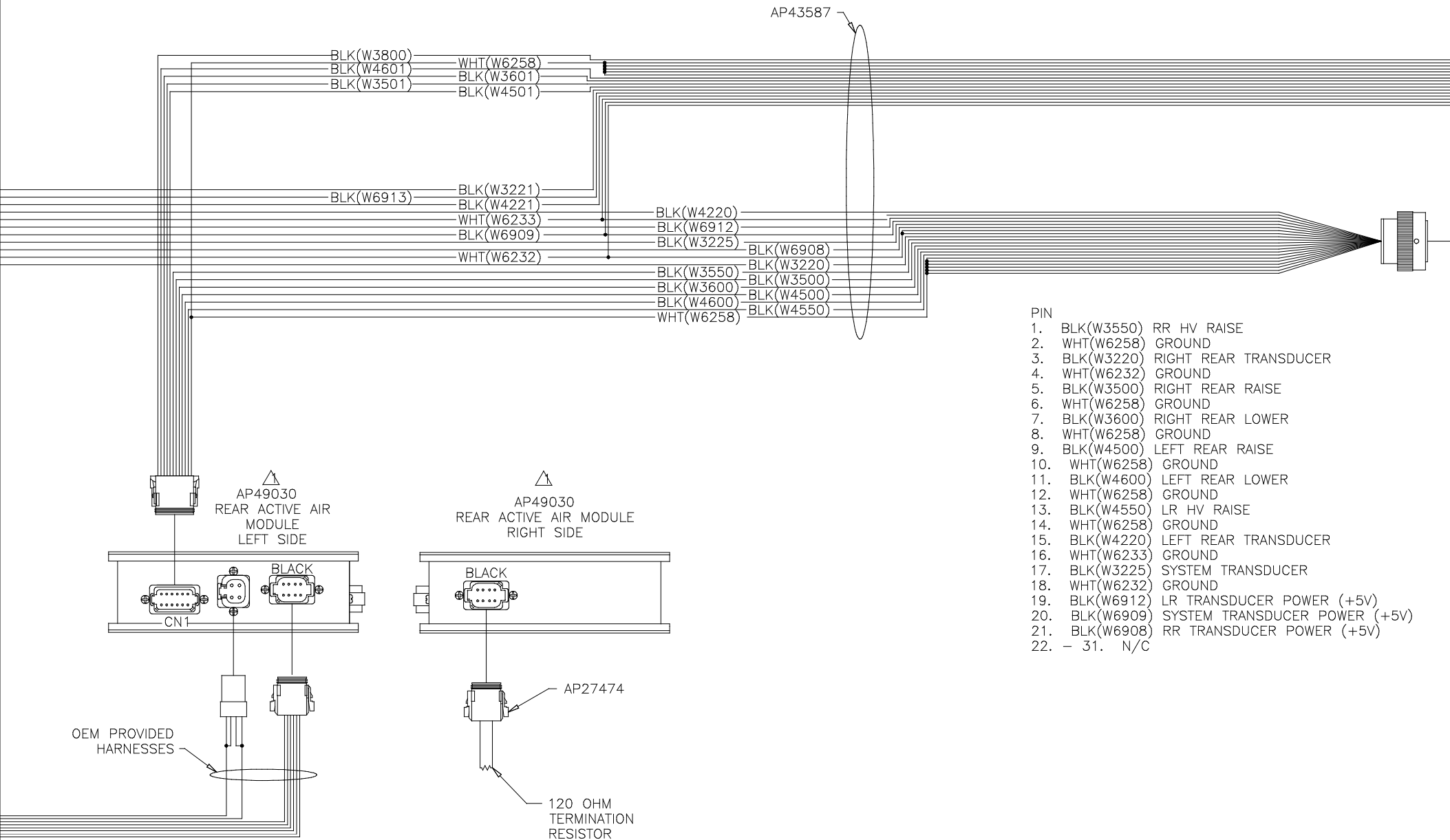

- PIN
1. BLK(W3550) RR HV RAISE
 2. WHT(W6258) GROUND
 3. BLK(W3220) RIGHT REAR TRANSDUCER
 4. WHT(W6232) GROUND
 5. BLK(W3500) RIGHT REAR RAISE
 6. WHT(W6258) GROUND
 7. BLK(W3600) RIGHT REAR LOWER
 8. WHT(W6258) GROUND
 9. BLK(W4500) LEFT REAR RAISE
 10. WHT(W6258) GROUND
 11. BLK(W4600) LEFT REAR LOWER
 12. WHT(W6258) GROUND
 13. BLK(W4550) LR HV RAISE
 14. WHT(W6258) GROUND
 15. BLK(W4220) LEFT REAR TRANSDUCER
 16. WHT(W6233) GROUND
 17. BLK(W3225) SYSTEM TRANSDUCER
 18. WHT(W6232) GROUND
 19. BLK(W6912) LR TRANSDUCER POWER (+5V)
 20. BLK(W6909) SYSTEM TRANSDUCER POWER (+5V)
 21. BLK(W6908) RR TRANSDUCER POWER (+5V)
 22. - 31. N/C

NOTE: INSTALLATION MUST CONFORM TO GOOD SHOP PRACTICES, SAE STANDARDS, RVIA STANDARDS, AND OTHER APPLICABLE STANDARDS.

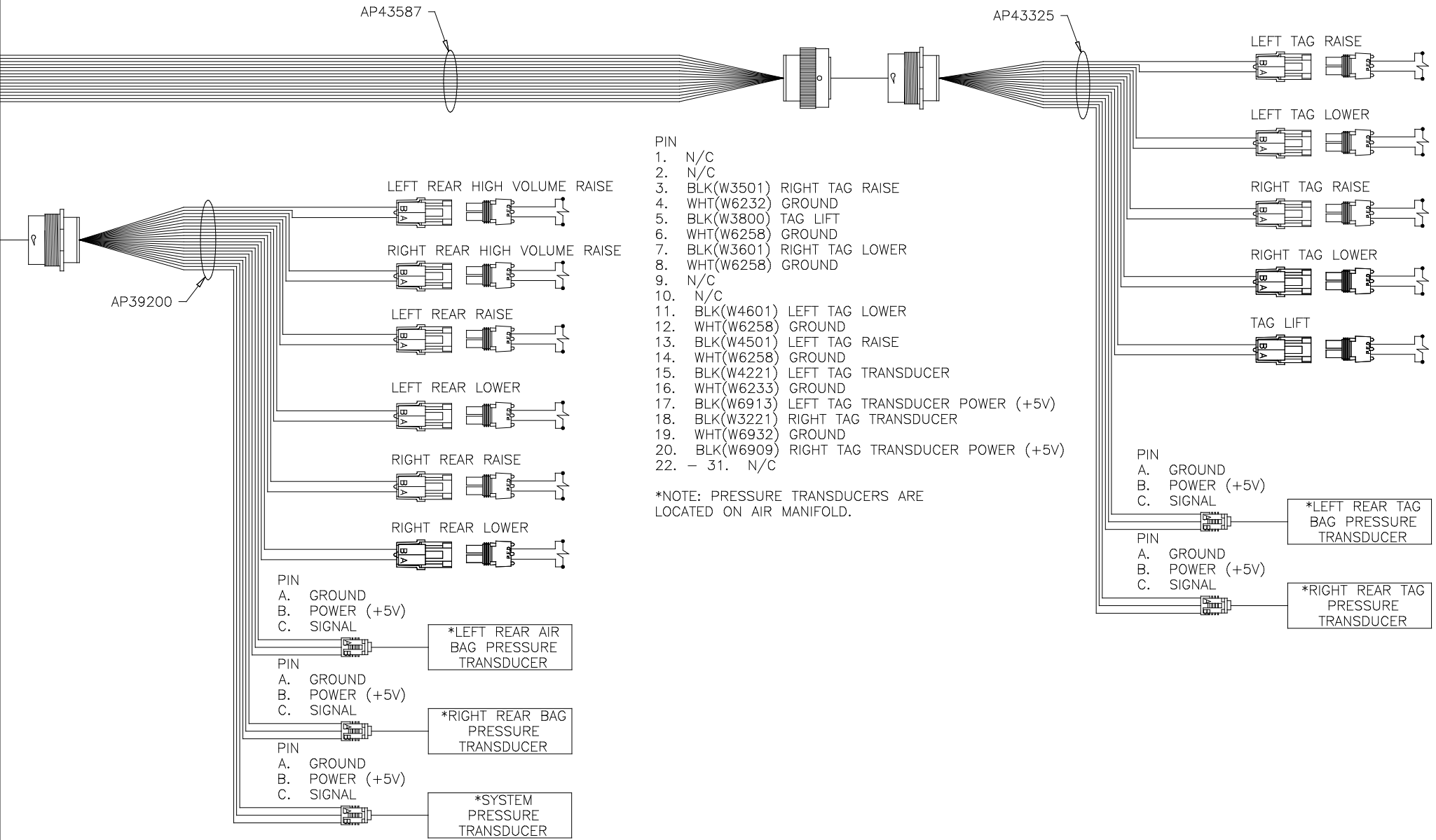

AP43587

AP43325

AP39200

- LEFT REAR HIGH VOLUME RAISE
- RIGHT REAR HIGH VOLUME RAISE
- LEFT REAR RAISE
- LEFT REAR LOWER
- RIGHT REAR RAISE
- RIGHT REAR LOWER

- PIN
1. N/C
 2. N/C
 3. BLK(W3501) RIGHT TAG RAISE
 4. WHT(W6232) GROUND
 5. BLK(W3800) TAG LIFT
 6. WHT(W6258) GROUND
 7. BLK(W3601) RIGHT TAG LOWER
 8. WHT(W6258) GROUND
 9. N/C
 10. N/C
 11. BLK(W4601) LEFT TAG LOWER
 12. WHT(W6258) GROUND
 13. BLK(W4501) LEFT TAG RAISE
 14. WHT(W6258) GROUND
 15. BLK(W4221) LEFT TAG TRANSDUCER
 16. WHT(W6233) GROUND
 17. BLK(W6913) LEFT TAG TRANSDUCER POWER (+5V)
 18. BLK(W3221) RIGHT TAG TRANSDUCER
 19. WHT(W6932) GROUND
 20. BLK(W6909) RIGHT TAG TRANSDUCER POWER (+5V)
 22. - 31. N/C

- LEFT TAG RAISE
- LEFT TAG LOWER
- RIGHT TAG RAISE
- RIGHT TAG LOWER
- TAG LIFT

- PIN
- A. GROUND
 - B. POWER (+5V)
 - C. SIGNAL
- *LEFT REAR AIR BAG PRESSURE TRANSDUCER
- PIN
- A. GROUND
 - B. POWER (+5V)
 - C. SIGNAL
- *RIGHT REAR BAG PRESSURE TRANSDUCER
- PIN
- A. GROUND
 - B. POWER (+5V)
 - C. SIGNAL
- *SYSTEM PRESSURE TRANSDUCER

- PIN
- A. GROUND
 - B. POWER (+5V)
 - C. SIGNAL
- *LEFT REAR TAG BAG PRESSURE TRANSDUCER
- PIN
- A. GROUND
 - B. POWER (+5V)
 - C. SIGNAL
- *RIGHT REAR TAG PRESSURE TRANSDUCER

*NOTE: PRESSURE TRANSDUCERS ARE LOCATED ON AIR MANIFOLD.

NOTE: INSTALLATION MUST CONFORM TO GOOD SHOP PRACTICES, SAE STANDARDS, RVIA STANDARDS, AND OTHER APPLICABLE STANDARDS.

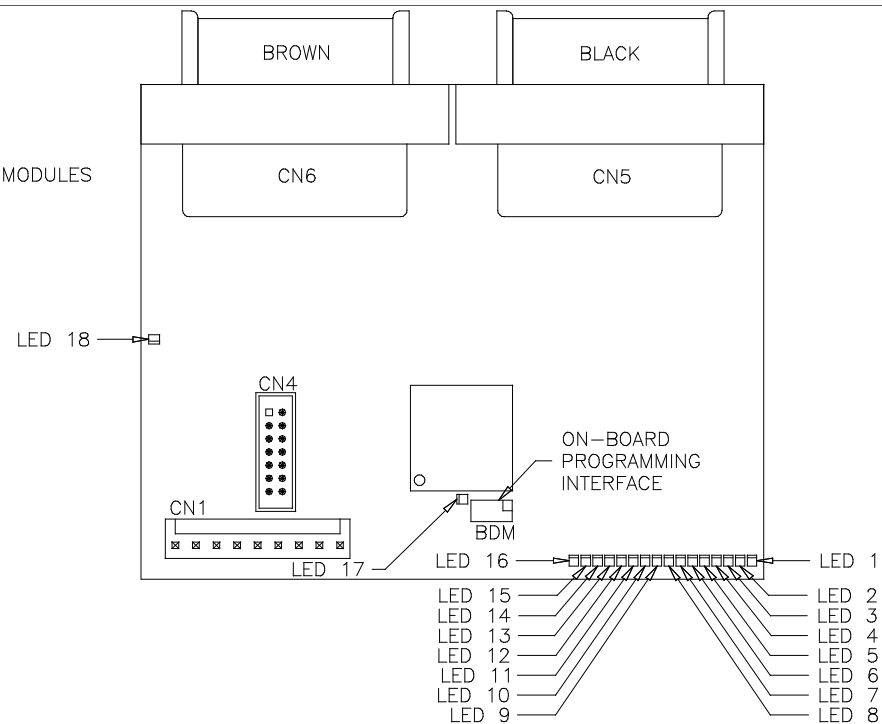
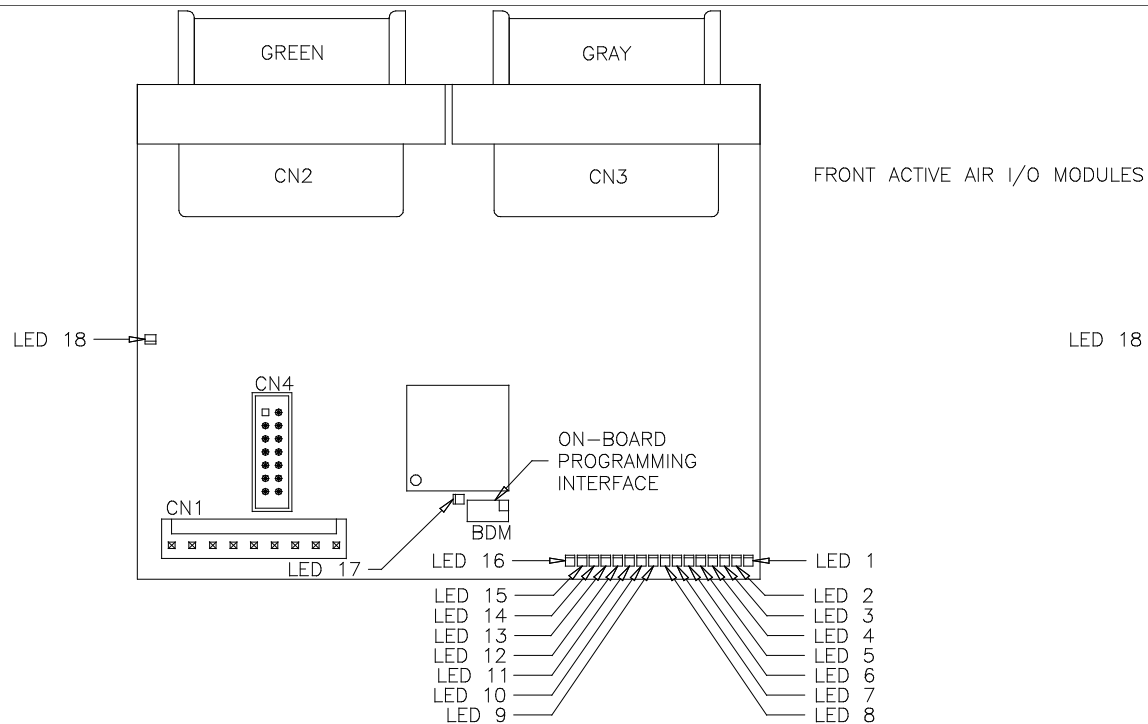

LED #	CONNECTOR	COLOR	DESCRIPTION
LED 1	CN3 PIN 1	RED	FRONT RIDE HEIGHT LOW
LED 2	CN3 PIN 2	GREEN	FRONT RIDE HEIGHT MED
LED 3	CN3 PIN 3	YELLOW	FRONT RIDE HEIGHT HIGH
LED 4	CN3 PIN 4	RED	ENCODE A
LED 5	CN3 PIN 5	GREEN	ENCODE B
LED 6	NOT USED	YELLOW	NOT USED
LED 7	NOT USED	RED	NOT USED
LED 8	CN3 PIN 8	GREEN	STEERING A
LED 9	CN3 PIN 9	YELLOW	STEERING B
LED 10	CN3 PIN 10	RED	TAG DUMP
LED 11	NOT USED	GREEN	NOT USED
LED 12	CN3 PIN 12	YELLOW	ROOM SELECT
LED 13	NOT USED	RED	NOT USED
LED 14	NOT USED	GREEN	NOT USED
LED 15	NOT USED	YELLOW	NOT USED
LED 16	NOT USED	RED	NOT USED
LED 17	NOT APPLICABLE	RED	LINK LIGHT
LED 18	NOT APPLICABLE	RED	POWER TO CAN MODULES

LED #	CONNECTOR	COLOR	DESCRIPTION
LED 1	CN5 PIN 1	RED	ROOM 1 ROOM IN
LED 2	CN5 PIN 2	GREEN	ROOM 1 ROOM OUT
LED 3	CN5 PIN 3	YELLOW	ROOM 1 VACUUM SENSOR
LED 4	CN5 PIN 4	RED	ROOM 4 ROOM IN
LED 5	CN5 PIN 5	GREEN	ROOM 4 ROOM OUT
LED 6	CN5 PIN 6	YELLOW	EXTEND (ROOM 1 AND 4)
LED 7	CN5 PIN 7	RED	RETRACT (ROOM 1 AND 4)
LED 8	CN5 PIN 8	GREEN	ROOM 4 VACUUM SENSOR
LED 9	NOT USED	YELLOW	NOT USED
LED 10	NOT USED	RED	NOT USED
LED 11	NOT USED	GREEN	NOT USED
LED 12	NOT USED	YELLOW	NOT USED
LED 13	NOT USED	RED	NOT USED
LED 14	NOT USED	GREEN	NOT USED
LED 15	NOT USED	YELLOW	NOT USED
LED 16	CN6 PIN 8	RED	SYSTEM WAKE UP
LED 17	NOT APPLICABLE	RED	LINK LIGHT
LED 18	NOT APPLICABLE	RED	POWER TO CAN MODULES

NOTE: INSTALLATION MUST CONFORM TO GOOD SHOP PRACTICES, SAE STANDARDS, RVIA STANDARDS, AND OTHER APPLICABLE STANDARDS.

MP90564 L
10DEC10

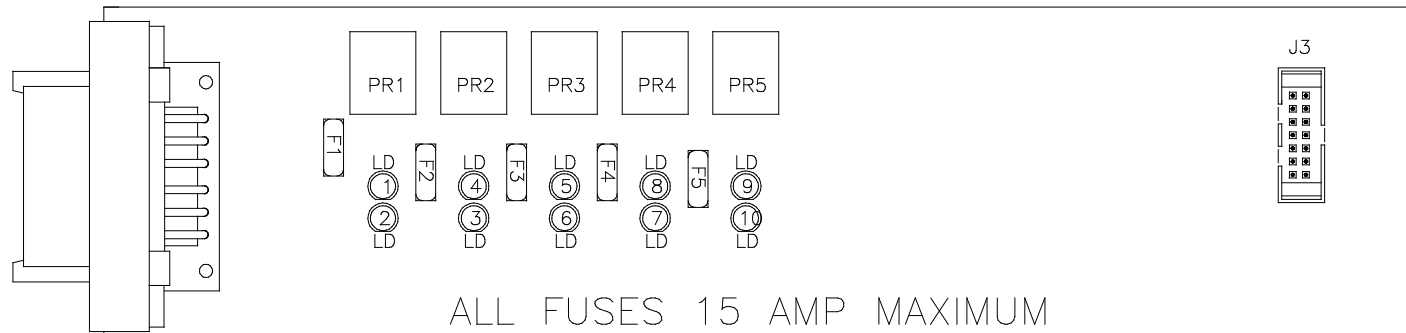

FRONT AIR
LED LAYOUT

LED #	COLOR	FUSE #	OUTPUT	RELAY #	DESCRIPTION
LED1	YELLOW	---	---	PR1	LEFT FRONT RAISE (COIL)
LED2	RED	FUSE 1	PIN 1	PR1	LEFT FRONT RAISE (CONTACT)
LED3	RED	FUSE 2	PIN 2	PR2	LEFT FRONT LOWER (CONTACT)
LED4	YELLOW	---	---	PR2	LEFT FRONT LOWER (COIL)
LED5	YELLOW	---	---	PR3	RIGHT FRONT RAISE (COIL)
LED6	RED	FUSE 3	PIN 3	PR3	RIGHT FRONT RAISE (CONTACT)
LED7	RED	FUSE 4	PIN 4	PR4	RIGHT FRONT LOWER (CONTACT)
LED8	YELLOW	---	---	PR4	RIGHT FRONT LOWER (COIL)
LED9	YELLOW	---	---	PR5	COMPRESSOR (COIL)
LED10	RED	FUSE 5	PIN 5	PR5	COMPRESSOR (CONTACT)

GENERATOR SLIDE/STEP COVER
REED SWITCH
LAYOUT

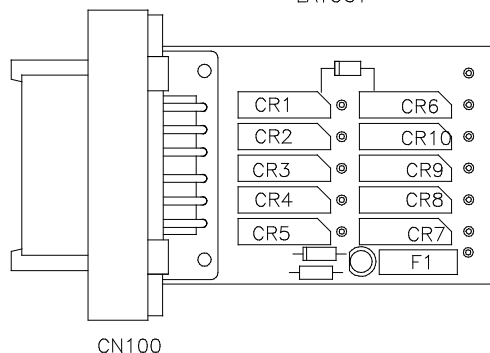

CN100

CONNECTOR	REED SWITCH	DESCRIPTION
CN 100 PIN 1	CR1	GEN SLIDE EXTEND
CN 100 PIN 2	CR2	NOT USED
CN 100 PIN 3	CR3	NOT USED
CN 100 PIN 4	CR4	NOT USED
CN 100 PIN 5	CR5	NOT USED
CN 100 PIN 6	---	GROUND
CN 100 PIN 7	---	NOT USED
CN 100 PIN 8	CR7	NOT USED
CN 100 PIN 9	CR8	NOT USED
CN 100 PIN 10	CR9	NOT USED
CN 100 PIN 11	CR10	NOT USED
CN 100 PIN 12	CR6	GEN SLIDE RETRACT

NOTE: INSTALLATION MUST CONFORM TO GOOD SHOP PRACTICES, SAE STANDARDS, RVIA STANDARDS, AND OTHER APPLICABLE STANDARDS.

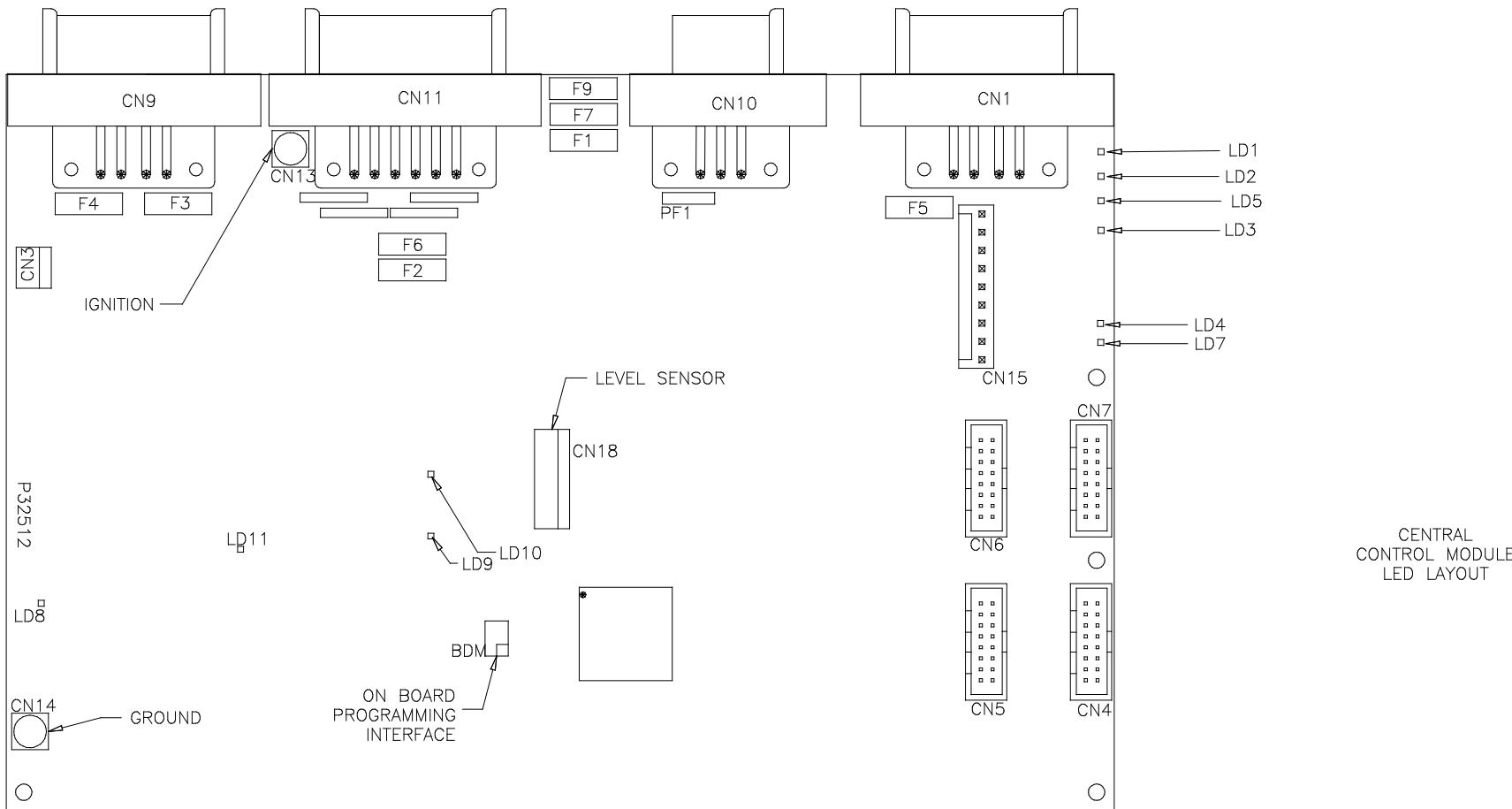

CENTRAL CONTROL MODULE LED LAYOUT

LED #	CONNECTOR	COLOR	DESCRIPTION
LED 1	CN 9 PIN 1	RED	MASTER RELAY
LED 2	CN 9 PIN 4	RED	PUMP RELAY
LED 3	CN 1 PIN 3	RED	SW 12V
LED 4	CN 11 PIN 12	RED	ENGINE BATT
LED 5	CN 9 PIN 5	RED	SPEED SWITCH
LED 7	CN 1 PIN 7 & 8	RED	LINK LIGHT
LED 8	CN 11 PIN 8 & 9	RED	NEUTRAL HOLD
LED 9	NOT USED	NOT USED	NOT USED
LED 10	CN9 PIN 2	RED	3000 LBS. PSW
LED 11	CN11 PIN 11	RED	PARK BRAKE

FUSE #	DESCRIPTION
PF1	RESET OUT
F7	ACCESSORY
F1	IGNITION
F2	HOUSE BATTERY
F3	MASTER RELAY
F4	PUMP RELAY
F5	SW. BATT TO CAN MODULES
F6	ENGINE BATTERY
F9	POWER TO CN100

NOTE: INSTALLATION MUST CONFORM TO GOOD SHOP PRACTICES, SAE STANDARDS, RVIA STANDARDS, AND OTHER APPLICABLE STANDARDS.

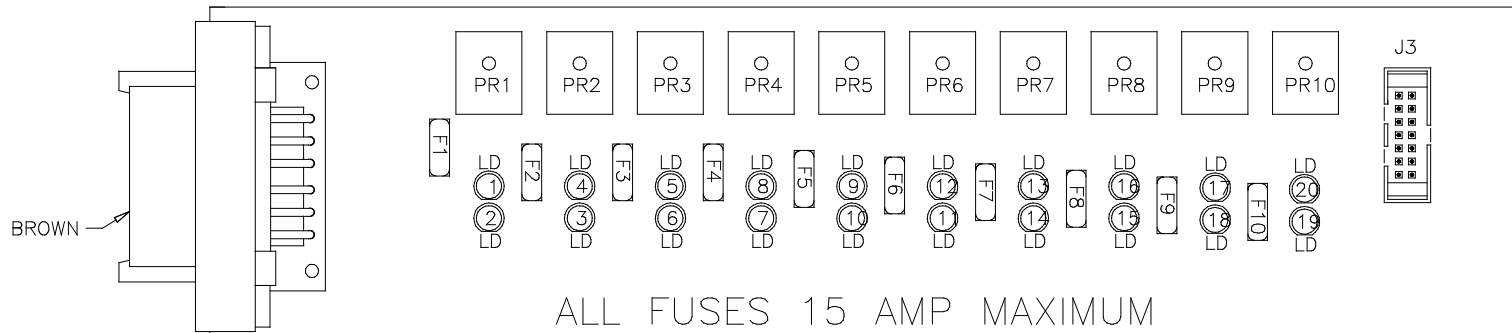

ROOM OUTPUTS
LED LAYOUT

LED #	COLOR	FUSE #	OUTPUT	RELAY #	DESCRIPTION
LED1	YELLOW	---	---	PR1	CYLINDER EXTEND 1 (COIL)
LED2	RED	FUSE 1	PIN 1	PR1	CYLINDER EXTEND 1 (CONTACT)
LED3	RED	FUSE 2	PIN 2	PR2	CYLINDER RETRACT 1 (CONTACT)
LED4	YELLOW	---	---	PR2	CYLINDER RETRACT 1 (COIL)
LED5	YELLOW	---	---	PR3	AIR SEAL ROOM 1 (COIL)
LED6	RED	FUSE 3	PIN 3	PR3	AIR SEAL ROOM 1 (CONTACT)
LED7	RED	FUSE 4	PIN 4	PR4	VACUUM ROOM 1 (CONTACT)
LED8	YELLOW	---	---	PR4	VACUUM ROOM 1 (COIL)
LED9	YELLOW	---	---	PR5	CYLINDER EXTEND 4 (COIL)
LED10	RED	FUSE 5	PIN 5	PR5	CYLINDER EXTEND 4 (CONTACT)
LED11	RED	FUSE 6	PIN 6	PR6	CYLINDER RETRACT 4 (CONTACT)
LED12	YELLOW	---	---	PR6	CYLINDER RETRACT 4 (COIL)
LED13	YELLOW	---	---	PR7	AIR SEAL ROOM 4 (COIL)
LED14	RED	FUSE 7	PIN 7	PR7	AIR SEAL ROOM 4 (CONTACT)
LED15	RED	FUSE 8	PIN 8	PR8	VACCUM ROOM 4 (CONTACT)
LED16	YELLOW	---	---	PR8	VACCUM ROOM 4 (COIL)
LED17	YELLOW	---	---	PR9	CYLINDER EXTEND GEN (COIL)
LED18	RED	FUSE 9	PIN 9	PR9	CYLINDER EXTEND GEN (CONTACT)
LED19	RED	FUSE 10	PIN 10	PR10	CYLINDER RETRACT GEN (CONTACT)
LED20	YELLOW	---	---	PR10	CYLINDER RETRACT GEN (COIL)

NOTE: INSTALLATION MUST CONFORM TO GOOD SHOP PRACTICES, SAE STANDARDS, RVIA STANDARDS, AND OTHER APPLICABLE STANDARDS.

MP90564 0
10DEC10

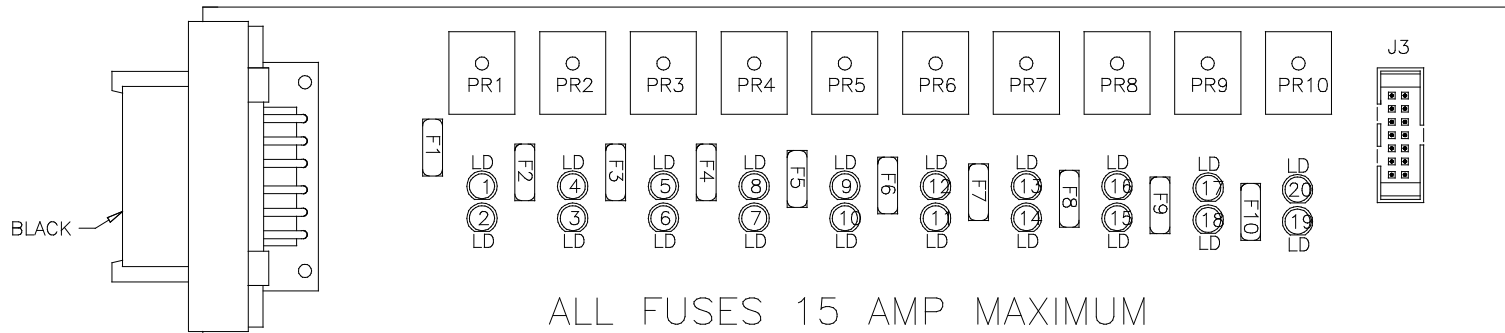

ROOM OUTPUTS
LED LAYOUT

LED #	COLOR	FUSE #	OUTPUT	RELAY #	DESCRIPTION
LED1	YELLOW	---	---	PR1	CYLINDER EXTEND 2 (COIL)
LED2	RED	FUSE 1	PIN 1	PR1	CYLINDER EXTEND 2 (CONTACT)
LED3	RED	FUSE 2	PIN 2	PR2	CYLINDER RETRACT 2 (CONTACT)
LED4	YELLOW	---	---	PR2	CYLINDER RETRACT 2 (COIL)
LED5	YELLOW	---	---	PR3	AIR SEAL ROOM 2 (COIL)
LED6	RED	FUSE 3	PIN 3	PR3	AIR SEAL ROOM 2 (CONTACT)
LED7	RED	FUSE 4	PIN 4	PR4	VACUUM ROOM 2 (CONTACT)
LED8	YELLOW	---	---	PR4	VACUUM ROOM 2 (COIL)
LED9	YELLOW	---	---	PR5	CYLINDER EXTEND 3 (COIL)
LED10	RED	FUSE 5	PIN 5	PR5	CYLINDER EXTEND 3 (CONTACT)
LED11	RED	FUSE 6	PIN 6	PR6	CYLINDER RETRACT 3 (CONTACT)
LED12	YELLOW	---	---	PR6	CYLINDER RETRACT 3 (COIL)
LED13	YELLOW	---	---	PR7	AIR SEAL ROOM 3 (COIL)
LED14	RED	FUSE 7	PIN 7	PR7	AIR SEAL ROOM 3 (CONTACT)
LED15	RED	FUSE 8	PIN 8	PR8	VACCUM ROOM 3 (CONTACT)
LED16	YELLOW	---	---	PR8	VACCUM ROOM 3 (COIL)
LED17	YELLOW	---	---	PR9	NOT USED
LED18	RED	FUSE 9	PIN 9	PR9	NOT USED
LED19	RED	FUSE 10	PIN 10	PR10	NOT USED
LED20	YELLOW	---	---	PR10	NOT USED

NOTE: INSTALLATION MUST CONFORM TO GOOD SHOP PRACTICES, SAE STANDARDS, RVIA STANDARDS, AND OTHER APPLICABLE STANDARDS.

MP90564 P
10DEC10

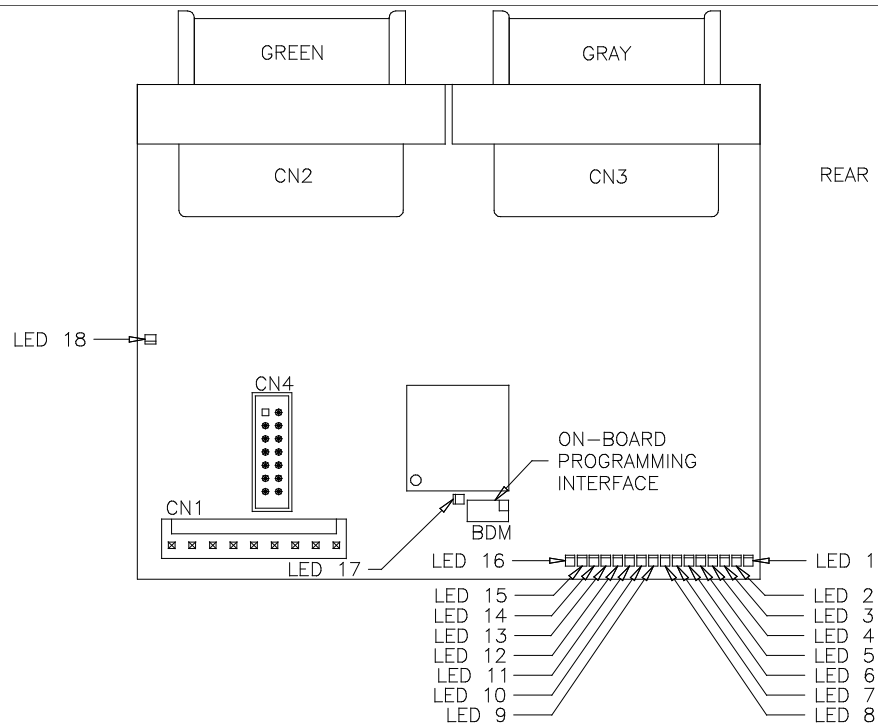

REAR ACTIVE AIR I/O MODULES

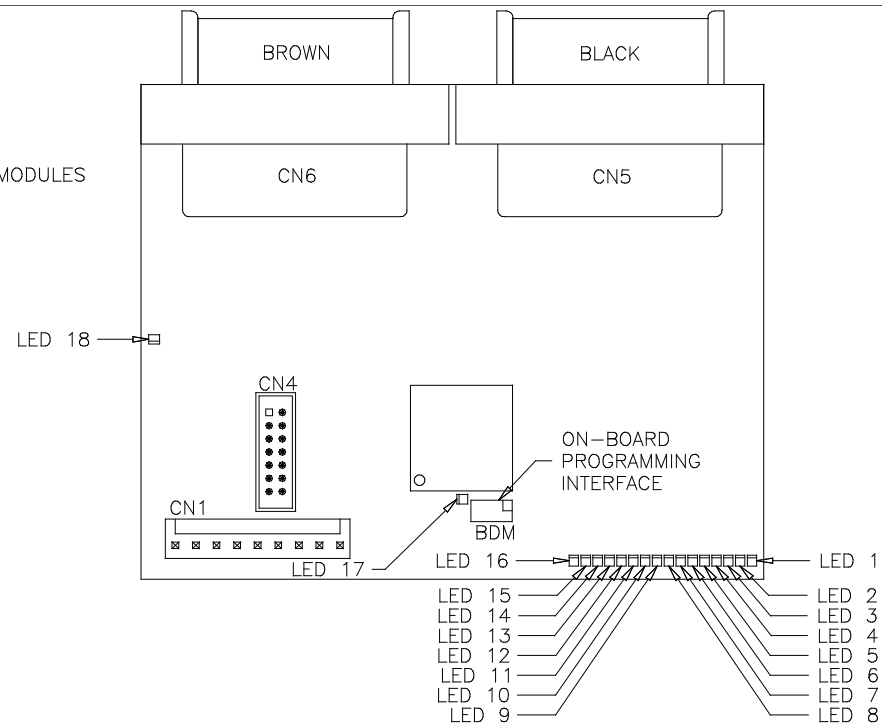

LED #	CONNECTOR	COLOR	DESCRIPTION
LED 1	CN3 PIN 1	RED	LR RIDE HEIGHT LOW
LED 2	CN3 PIN 2	GREEN	LR RIDE HEIGHT MED
LED 3	CN3 PIN 3	YELLOW	LR RIDE HEIGHT HIGH
LED 4	CN3 PIN 4	RED	LR ENCODE A
LED 5	CN3 PIN 5	GREEN	LR ENCODE B
LED 6	CN3 PIN 6	YELLOW	EXTEND (ROOM 2 AND 3)
LED 7	CN3 PIN 7	RED	RETRACT (ROOM 2 AND 3)
LED 8	NOT USED	GREEN	NOT USED
LED 9	NOT USED	YELLOW	NOT USED
LED 10	CN3 PIN 10	RED	ROOM 2 ROOM IN
LED 11	CN3 PIN 11	GREEN	ROOM 2 ROOM OUT
LED 12	CN3 PIN 12	YELLOW	ROOM 2 VACUUM SENSOR
LED 13	NOT USED	RED	NOT USED
LED 14	NOT USED	GREEN	NOT USED
LED 15	NOT USED	YELLOW	NOT USED
LED 16	CN2 PIN 8	RED	SYSTEM WAKE UP
LED 17	NOT APPLICABLE	RED	LINK LIGHT
LED 18	NOT APPLICABLE	RED	POWER TO CAN MODULES

LED #	CONNECTOR	COLOR	DESCRIPTION
LED 1	CN5 PIN 1	RED	RR RIDE HEIGHT LOW
LED 2	CN5 PIN 2	GREEN	RR RIDE HEIGHT MED
LED 3	CN5 PIN 3	YELLOW	RR RIDE HEIGHT HIGH
LED 4	CN5 PIN 4	RED	RR ENCODE A
LED 5	CN5 PIN 5	GREEN	RR ENCODE B
LED 6	CN5 PIN 6	YELLOW	ROOM SELECT
LED 7	NOT USED	RED	NOT USED
LED 8	NOT USED	GREEN	NOT USED
LED 9	NOT USED	YELLOW	NOT USED
LED 10	CN5 PIN 10	RED	ROOM 3 ROOM IN
LED 11	CN5 PIN 11	GREEN	ROOM 3 ROOM OUT
LED 12	CN5 PIN 12	YELLOW	ROOM 3 VACUUM SENSOR
LED 13	NOT USED	RED	NOT USED
LED 14	NOT USED	GREEN	NOT USED
LED 15	NOT USED	YELLOW	NOT USED
LED 16	NOT USED	RED	NOT USED
LED 17	NOT APPLICABLE	RED	LINK LIGHT
LED 18	NOT APPLICABLE	RED	POWER TO CAN MODULES

NOTE: INSTALLATION MUST CONFORM TO GOOD SHOP PRACTICES, SAE STANDARDS, RVIA STANDARDS, AND OTHER APPLICABLE STANDARDS.

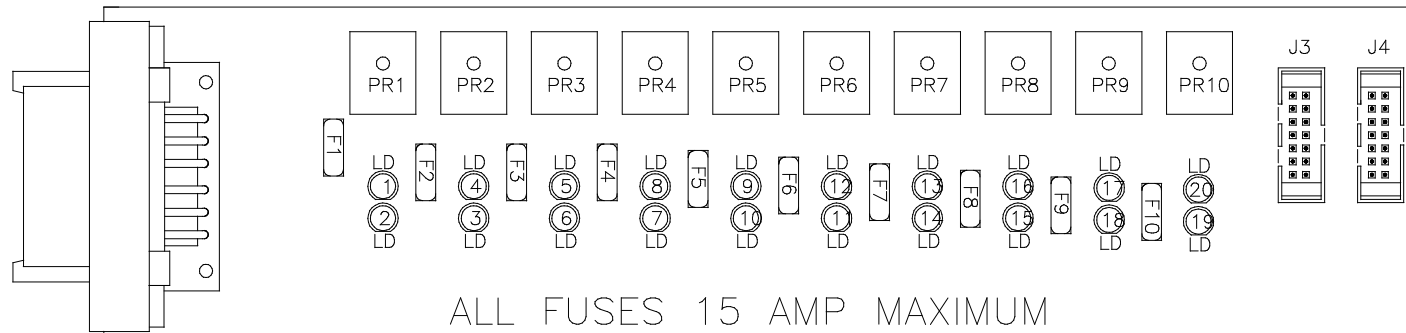

REAR AIR
LED LAYOUT

LED #	COLOR	FUSE #	OUTPUT	RELAY #	DESCRIPTION
LED1	YELLOW	---	---	PR1	LEFT REAR RAISE (COIL)
LED2	RED	FUSE 1	PIN 1	PR1	LEFT REAR RAISE (CONTACT)
LED3	RED	FUSE 2	PIN 2	PR2	LEFT REAR LOWER (CONTACT)
LED4	YELLOW	---	---	PR2	LEFT REAR LOWER (COIL)
LED5	YELLOW	---	---	PR3	LEFT REAR HIGH VOL RAISE (COIL)
LED6	RED	FUSE 3	PIN 3	PR3	LEFT REAR HIGH VOL RAISE (CONTACT)
LED7	RED	FUSE 4	PIN 4	PR4	LEFT REAR TAG LOWER (CONTACT)
LED8	YELLOW	---	---	PR4	LEFT REAR TAG LOWER (COIL)
LED9	YELLOW	---	---	PR5	RIGHT REAR RAISE (COIL)
LED10	RED	FUSE 5	PIN 5	PR5	RIGHT REAR RAISE (CONTACT)
LED11	RED	FUSE 6	PIN 6	PR6	RIGHT REAR LOWER (CONTACT)
LED12	YELLOW	---	---	PR6	RIGHT REAR LOWER (COIL)
LED13	YELLOW	---	---	PR7	RIGHT REAR HIGH VOL RAISE (COIL)
LED14	RED	FUSE 7	PIN 7	PR7	RIGHT REAR HIGH VOL RAISE (CONTACT)
LED15	RED	FUSE 8	PIN 8	PR8	RIGHT REAR TAG LOWER (CONTACT)
LED16	YELLOW	---	---	PR8	RIGHT REAR TAG LOWER (COIL)
LED17	YELLOW	---	---	PR9	LEFT REAR TAG RAISE (COIL)
LED18	RED	FUSE 9	PIN 9	PR9	LEFT REAR TAG RAISE (CONTACT)
LED19	RED	FUSE 10	PIN 10	PR10	RIGHT REAR TAG RAISE (CONTACT)
LED20	YELLOW	---	---	PR10	RIGHT REAR TAG RAISE (COIL)

NOTE: INSTALLATION MUST CONFORM TO GOOD SHOP PRACTICES, SAE STANDARDS, RVIA STANDARDS, AND OTHER APPLICABLE STANDARDS.

MP90564 R
10DEC10