

LOCATING PIN

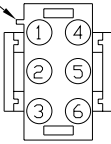

DETAIL 'A'
TYPICAL

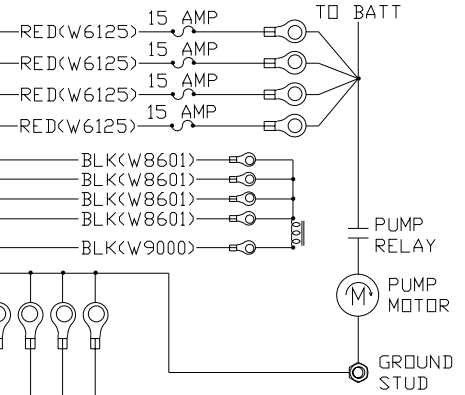
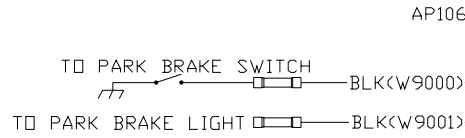

DETAIL 'A'

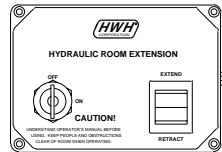
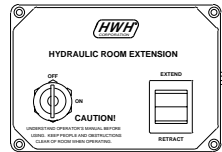
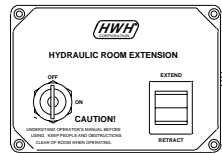
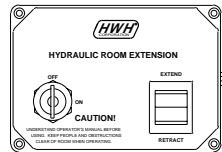

- PIN - TYPICAL
1. BLK(W8601) PUMP CONTROL
 2. BLK(W5000) ROOM EXTEND
 3. BLK(W5100) ROOM RETRACT
 4. N/C
 5. N/C
 6. RED(W6125) BATTERY

AP42505
(4 USED)

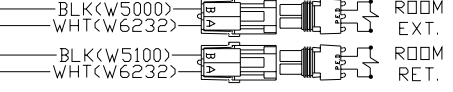
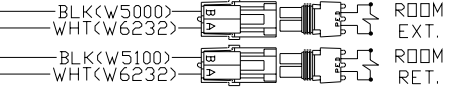
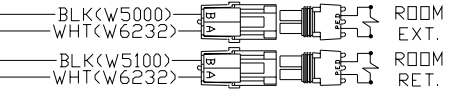
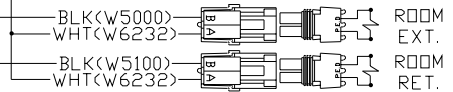
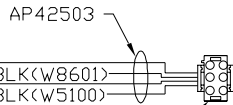
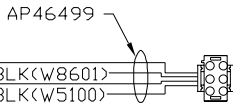
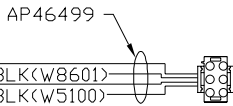
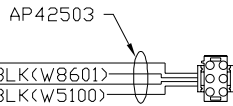

NO.	DATE	REVISION

HWH I-80 EXIT 267 SOUTH
RT 1 MOSCOW, IOWA 52760

SCALE 1:3 DATE 10AUG11 DRAWN BY .

SYSTEM SCHEMATIC ELEC

NOTE: INSTALLATION MUST CONFORM TO GOOD SHOP PRACTICES, SAE STANDARDS, RVIA STANDARDS, AND OTHER APPLICABLE STANDARDS.

THE INFORMATION DISCLOSED ON THIS DRAWING IS CONFIDENTIAL AND MUST NOT BE DISCLOSED OR USED IN ANY MANNER WHICH WILL BE DETRIMENTAL TO THE HWH CORPORATION

DRAWING NUMBER
MP906520