

AP34262 FRONT AIR/ROOM 1 AND 4 MODULE

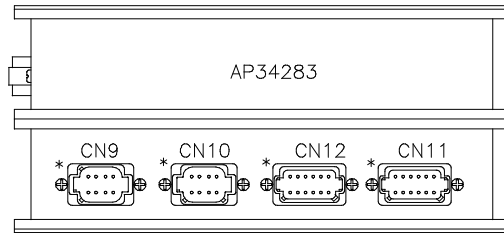
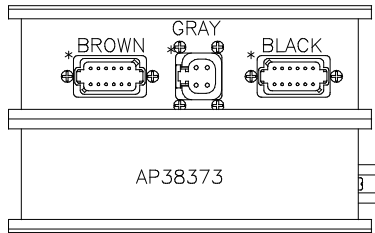

\* DESIGNATES PIN 1 OF CONNECTORS

AP34283 (BROWN)  
PIN

- 1 N/C
- 2 BLK(W1500) LEFT FRONT RAISE
- 3 BLK(W1600) LEFT FRONT LOWER
- 4 BLK(W2500) RIGHT FRONT RAISE
- 5 BLK(W2600) RIGHT FRONT LOWER
- 6 BLK(W9700) COMPRESSOR
- 7 N/C
- 8 BLK(W1700) TRAVEL
- 9 N/C
- 10 N/C
- 11 WHT(W6254) GROUND
- 12 N/C

AP34283 (GRAY)  
PIN

- 1 RED(W6800) SW BATT
- 2 RED(W6800) SW BATT
- 3 GRN(W6230) GND
- 4 GRN(W6230) GND

AP34283 (BLACK)  
PIN

- 1 BLK(W5650) VACUUM ROOM 1
- 2 BLK(W5600) AIR SEAL ROOM 1
- 3 BLK(W5651) VACCUM ROOM 4
- 4 BLK(W5601) AIR SEAL ROOM 4
- 5 N/C
- 6 N/C
- 7 N/C
- 8 N/C
- 9 N/C
- 10 N/C
- 11 WHT(W6230) GROUND
- 12 N/C

AP38373 CN9(BLACK)  
PIN

- 1 WHT(W7696) SYSTEM WAKE UP
- 2 N/C
- 3 RED(W6800) SW BATTERY
- 4 GRN(W6230) GROUND
- 5 CAN SHIELD
- 6 RED(W6110) IGNITION
- 7 GRN CAN LOW
- 8 YEL CAN HI

AP38373 CN10(GRAY)  
PIN

- 1 BLK(W6806) ROOM SELECT
- 2 WHT(W7510) READY TO OPERATE
- 3 WHT(W7530) PUMP
- 4 WHT(W7501) EXTEND (ROOM 1 AND 4)
- 5 WHT(W7502) RETRACT (ROOM 1 AND 4)
- 6 RED(W6805) SW BATTERY
- 7 WHT(W7696) SYSTEM WAKE UP
- 8 GRN(W6230) GROUND

AP38373 CN12(GRAY)  
PIN

- 1 N/C
- 2 BLK(W5701) ROOM 1 OUT
- 3 BLK(W5703) ROOM 1 IN
- 4 N/C
- 5 N/C
- 6 WHT(W6236) GROUND
- 7 BLK(W6800) SW. BATTERY
- 8 BLK(W5651) ROOM 1 VACUUM SENSOR
- 9 N/C
- 10 BLK(W2210) RIGHT FRONT AIR PRESSURE SW.
- 11 BLK(W7521) TAG DUMP
- 12 N/C

AP38373 CN 11 (GREEN)  
PIN

- 1 BLK(W5652) ROOM 4 VACUUM SENSOR
- 2 BLK(W5700) ROOM 4 ROOM OUT
- 3 BLK(W5702) ROOM 4 ROOM IN
- 4 N/C
- 5 N/C
- 6 WHT(W6236) GROUND
- 7 BLK(W6801) SW. BATT
- 8 N/C
- 9 N/C
- 10 BLK(W1210) LEFT FRONT AIR PRESSURE SW.
- 11 N/C
- 12 N/C

			HWH I-80 EXIT 267 SOUTH RT 1 MOSCOW, IOWA 52760		
			SCALE 1:3	DATE 16AUG11	
			DRAWN BY .		
1	13AUG12	CORRECTED WIRE NUMBERS	SYSTEM SCHEMATIC ELEC		
NO.	DATE	REVISION			
THE INFORMATION DISCLOSED ON THIS DRAWING IS CONFIDENTIAL AND MUST NOT BE DISCLOSED OR USED IN ANY MANNER WHICH WILL BE DETRIMENTAL TO THE HWH CORPORATION			DRAWING NUMBER MP90681 A/s		

NOTE: INSTALLATION MUST CONFORM TO GOOD SHOP PRACTICES, SAE STANDARDS, RVIA STANDARDS, AND OTHER APPLICABLE STANDARDS.

AP48835  
CENTRAL CONTROL  
MODULES

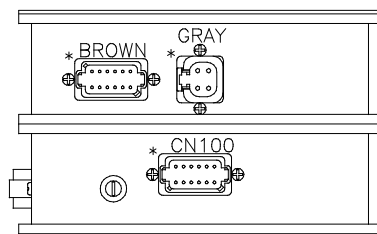
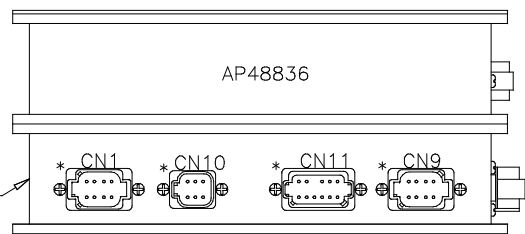

110 NEUTRAL HOLD ENABLED  
220 NEUTRAL HOLD DISABLED

AP48836 (BROWN)

PIN	Color	Function
1	BLK(W5050)	CYLINDER EXTEND 1
2	BLK(W5150)	CYLINDER RETRACT 1
3	BLK(W5051)	CYLINDER EXTEND 2
4	BLK(W5151)	CYLINDER RETRACT 2
5	BLK(W5052)	CYLINDER EXTEND 3
6	BLK(W5152)	CYLINDER RETRACT 3
7	BLK(W5054)	CYLINDER EXTEND GEN
8	BLK(W5154)	CYLINDER RETRACT GEN
9	BLK(W5153)	CYLINDER RETRACT 4
10	BLK(W5053)	CYLINDER EXTEND 4
11	N/C	
12	N/C	

AP48836 (GRAY)

PIN	Color	Function
1	RED(W6800)	SW BATT
2	RED(W6800)	SW BATT
3	GRN(W6230)	GROUND
4	GRN(W6230)	GROUND

AP37842 CN100(GRAY)

PIN	Color	Function
1	BLK(W5000)	GEN SLIDE EXTEND
2	N/C	
3	N/C	
4	N/C	
5	N/C	
6	WHT(W6230)	GROUND
7	N/C	
8	N/C	
9	N/C	
10	N/C	
11	N/C	
12	BLK(W5100)	GEN SLIDE RETRACT

AP37842 CN1(BLACK)

PIN	Color	Function
1	WHT(W7696)	SYSTEM WAKE UP
2	N/C	
3	RED(W6800)	SW BATT
4	GRN(W6230)	GND
5	CAN SHIELD	
6	RED(W6110)	IGNITION
7	GRN CAN LOW	
8	YEL CAN HI	

AP37842 CN10(GRAY)

PIN	Color	Function
1	BLK(W7599)	SWITCH LIGHT CONTROL
2	RED(W6100)	RESET OUT
3	BLK(W7550)	RESET IN
4	RED(W6121)	WARN LIGHT SUPPLY
5	WHT(W6230)	SWITCH LIGHT SUPPLY
6	BLK(W7699)	WARN LIGHT/BUZZER CONTROL

AP37842 CN11(GRAY)

PIN	Color	Function
1	RED(W6110)	IGNITION
2	N/C	
3	N/C	
4	N/C	
5	RED(W6120)	IGNITION
6	RED(W6100)	HOUSE BATTERY
7	GRN(W6230)	GROUND
8	WHT(W9961)	NEUTRAL HOLD
9	WHT(W9955)	NEUTRAL HOLD
10	N/C	
11	WHT(W9000)	PARK BRAKE SWITCH
12	RED(W6101)	HOUSE BATTERY

AP37842 CN9(GREEN)

PIN	Color	Function
1	BLK(W8500)	MASTER RELAY CNTRL
2	BLK(W8100)	SYSTEM PSW.
3	N/C	
4	BLK(W8600)	PMP RELAY CNTRL
5	BLK(W9900)	SPEED SWITCH
6	BLK(W9901)	PUMP MONITOR
7	N/C	
8	N/C	

NOTE: INSTALLATION MUST CONFORM TO GOOD SHOP PRACTICES, SAE STANDARDS, RVIA STANDARDS, AND OTHER APPLICABLE STANDARDS.

AP34289 (BROWN)

PIN	DESCRIPTION
1	BLK(W5650) ROOM 2 VACUUM
2	BLK(W5600) ROOM 2 AIR SEAL
3	BLK(W5651) ROOM 3 VACUUM
4	BLK(W5601) ROOM 3 AIR SEAL
5	N/C
6	N/C
7	N/C
8	N/C
9	N/C
10	N/C
11	WHT(W6230) GROUND
12	N/C

AP34289 (GRAY)

PIN	DESCRIPTION
1	RED (W6800) SW BATT
2	RED (W6800) SW BATT
3	GRN (W6230) GND
4	GRN (W6230) GND

AP34289 (BLACK)

PIN	DESCRIPTION
1	BLK(W3800) TAG LIFT
2	BLK(W4500) LEFT REAR RAISE
3	BLK(W4600) LEFT REAR LOWER
4	BLK(W3500) RIGHT REAR RAISE
5	BLK(W3600) RIGHT REAR LOWER
6	N/C
7	BLK(W3701) TAG TRAVEL
8	BLK(W3700) TRAVEL
9	BLK(W3601) TAG RIGHT LOWER
10	BLK(W4601) TAG LEFT LOWER
11	WHT(W6258) GROUND
12	N/C

AP34263  
REAR AIR/ROOM 2 AND 3  
MODULE

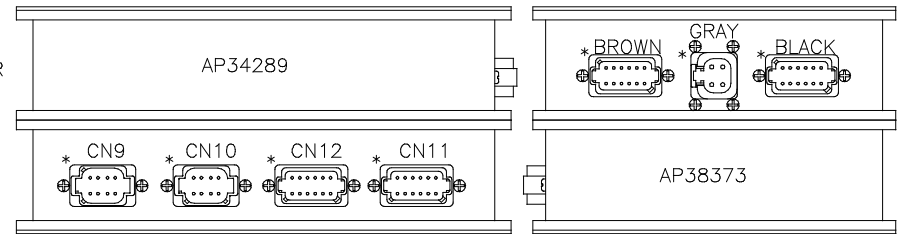

AP38373 CN9(BLACK)

PIN	DESCRIPTION
1	WHT(W7696) SYSTEM WAKE UP
2	RED(W6121) IGNITION
3	RED(W6800) SW BATTERY
4	GRN(W6230) GROUND
5	CAN SHIELD
6	RED(W6110) IGNITION
7	GRN CAN LOW
8	YEL CAN HI

AP38373 CN10(GRAY)

PIN	DESCRIPTION
1	BLK(W6806) ROOM SELECT
2	WHT(W7510) READY TO OPERATE
3	WHT(W7530) PUMP
4	WHT(W7501) EXTEND (ROOM 2 AND 3)
5	WHT(W7502) RETRACT (ROOM 2 AND 3)
6	RED(W6805) SW BATTERY
7	WHT(W7696) SYSTEM WAKE UP
8	GRN(W6230) GROUND

AP38373 CN12(GRAY)

PIN	DESCRIPTION
1	BLK(W4211) TAG LEFT SIDE PRESS. SW.
2	BLK(W5701) ROOM 2 OUT
3	BLK(W5703) ROOM 2 IN
4	BLK(W3211) TAG RIGHT SIDE PRESS. SW.
5	N/C
6	WHT(W6231) GROUND
7	RED(W6800) SW. BATTERY
8	BLK(W5651) ROOM 2 VACUUM SENSOR
9	BLK(W3215) SYSTEM PRESS. SW.
10	N/C
11	N/C
12	N/C

AP38373 CN 11(GREEN)

PIN	DESCRIPTION
1	BLK(W5652) ROOM 3 VACUUM SENSOR
2	BLK(W5700) ROOM 3 OUT
3	BLK(W5702) ROOM 3 IN
4	BLK(W3210) RIGHT REAR PRESS SW.
5	N/C
6	WHT(W6232) GROUND
7	BLK(W6801) SW. BATT
8	BLK(W4210) LEFT REAR PRESS SW.
9	N/C
10	N/C
11	N/C
12	N/C

NOTE: INSTALLATION MUST CONFORM TO GOOD SHOP PRACTICES, SAE STANDARDS, RVIA STANDARDS, AND OTHER APPLICABLE STANDARDS.

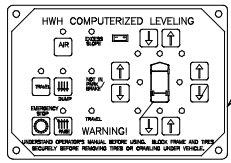

AP22703

120 OHM  
TERMINATION  
RESISTOR  
PART OF OEM  
PROVIDED TRUNK  
HARNESS #72308.

5 1

- PIN
- 1 YELLOW CAN HI
  - 2 GREEN CAN LOW
  - 3 CAN SHIELD
  - 4 GRN (W6230) GROUND
  - 5 RED (W6800) SW. BATTERY

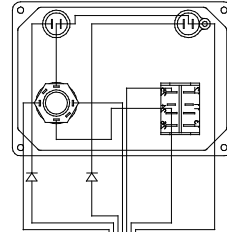

AP22475

OEM PROVIDED  
ROOM SELECTOR  
SWITCH

OEM PROVIDED

NOTE: INSTALLATION MUST CONFORM TO GOOD SHOP PRACTICES, SAE STANDARDS, RVIA STANDARDS, AND OTHER APPLICABLE STANDARDS.

MP90681 D  
16AUG11

AP34262 FRONT AIR/ROOM 1 & 4 MODULE

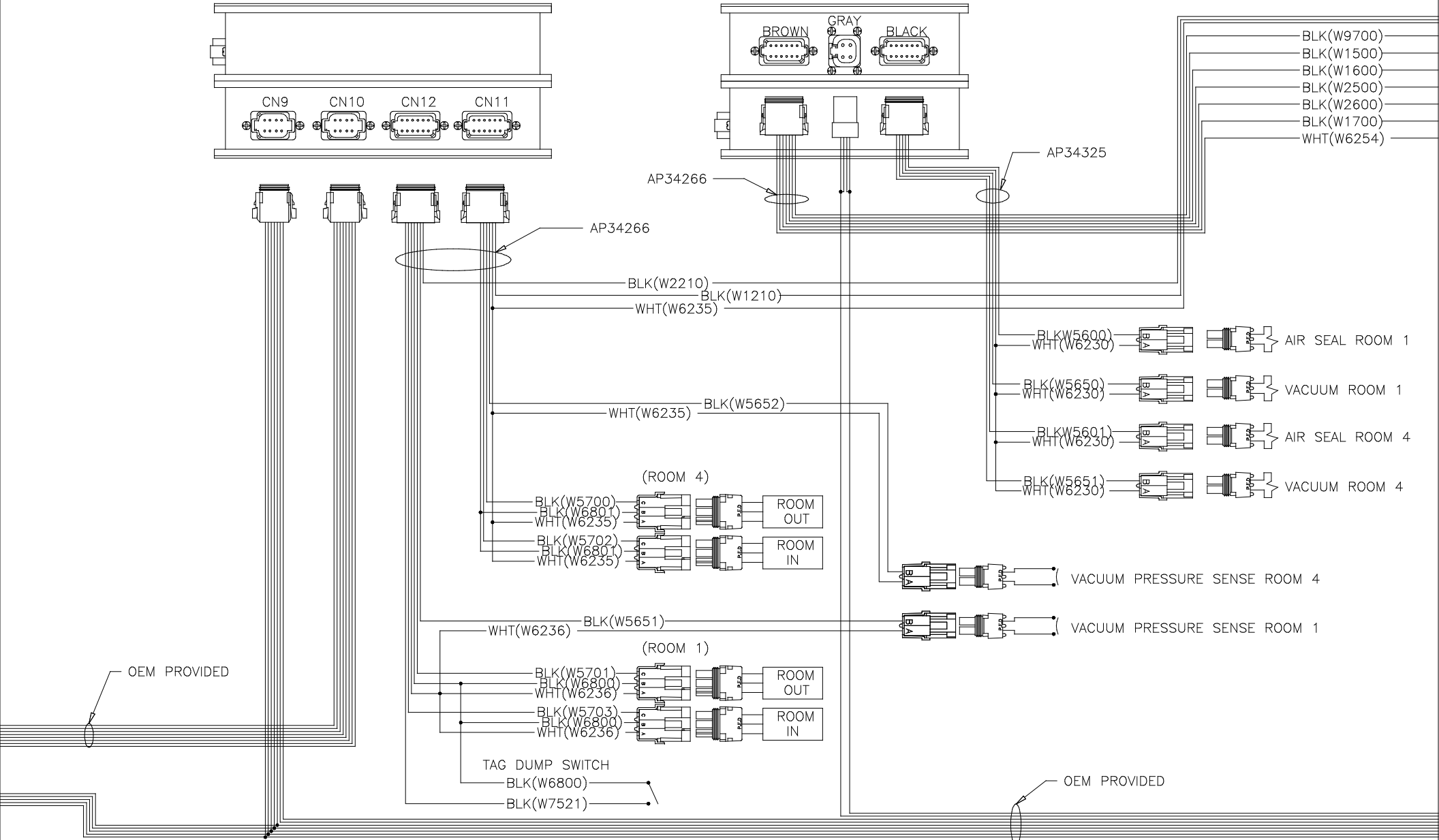

NOTE: INSTALLATION MUST CONFORM TO GOOD SHOP PRACTICES, SAE STANDARDS, RVIA STANDARDS, AND OTHER APPLICABLE STANDARDS.

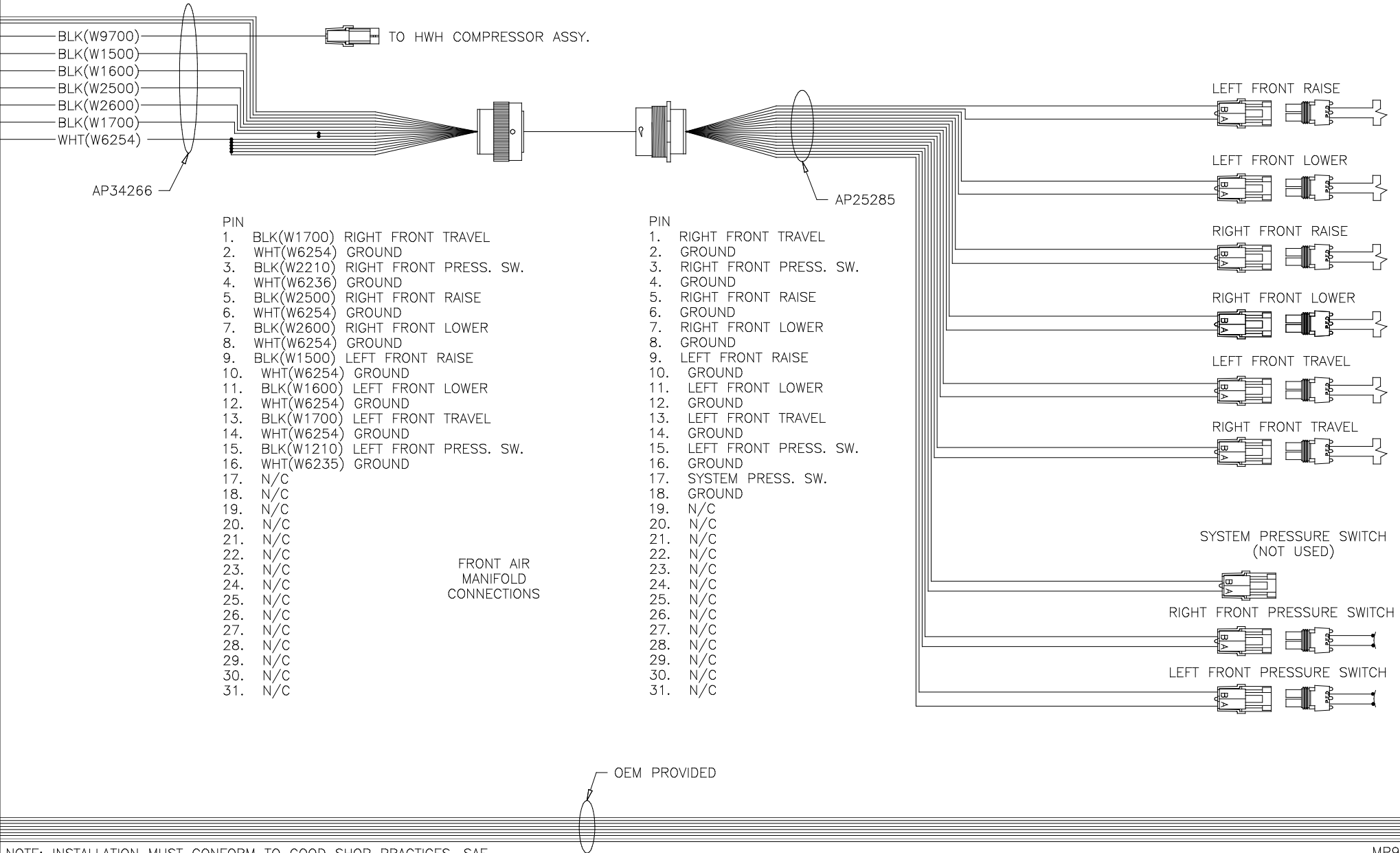

BLK(W9700)  
 BLK(W1500)  
 BLK(W1600)  
 BLK(W2500)  
 BLK(W2600)  
 BLK(W1700)  
 WHT(W6254)

TO HWH COMPRESSOR ASSY.

AP34266

- PIN
- 1. BLK(W1700) RIGHT FRONT TRAVEL
  - 2. WHT(W6254) GROUND
  - 3. BLK(W2210) RIGHT FRONT PRESS. SW.
  - 4. WHT(W6236) GROUND
  - 5. BLK(W2500) RIGHT FRONT RAISE
  - 6. WHT(W6254) GROUND
  - 7. BLK(W2600) RIGHT FRONT LOWER
  - 8. WHT(W6254) GROUND
  - 9. BLK(W1500) LEFT FRONT RAISE
  - 10. WHT(W6254) GROUND
  - 11. BLK(W1600) LEFT FRONT LOWER
  - 12. WHT(W6254) GROUND
  - 13. BLK(W1700) LEFT FRONT TRAVEL
  - 14. WHT(W6254) GROUND
  - 15. BLK(W1210) LEFT FRONT PRESS. SW.
  - 16. WHT(W6235) GROUND
  - 17. N/C
  - 18. N/C
  - 19. N/C
  - 20. N/C
  - 21. N/C
  - 22. N/C
  - 23. N/C
  - 24. N/C
  - 25. N/C
  - 26. N/C
  - 27. N/C
  - 28. N/C
  - 29. N/C
  - 30. N/C
  - 31. N/C

FRONT AIR  
 MANIFOLD  
 CONNECTIONS

- PIN
- 1. RIGHT FRONT TRAVEL
  - 2. GROUND
  - 3. RIGHT FRONT PRESS. SW.
  - 4. GROUND
  - 5. RIGHT FRONT RAISE
  - 6. GROUND
  - 7. RIGHT FRONT LOWER
  - 8. GROUND
  - 9. LEFT FRONT RAISE
  - 10. GROUND
  - 11. LEFT FRONT LOWER
  - 12. GROUND
  - 13. LEFT FRONT TRAVEL
  - 14. GROUND
  - 15. LEFT FRONT PRESS. SW.
  - 16. GROUND
  - 17. SYSTEM PRESS. SW.
  - 18. GROUND
  - 19. N/C
  - 20. N/C
  - 21. N/C
  - 22. N/C
  - 23. N/C
  - 24. N/C
  - 25. N/C
  - 26. N/C
  - 27. N/C
  - 28. N/C
  - 29. N/C
  - 30. N/C
  - 31. N/C

AP25285

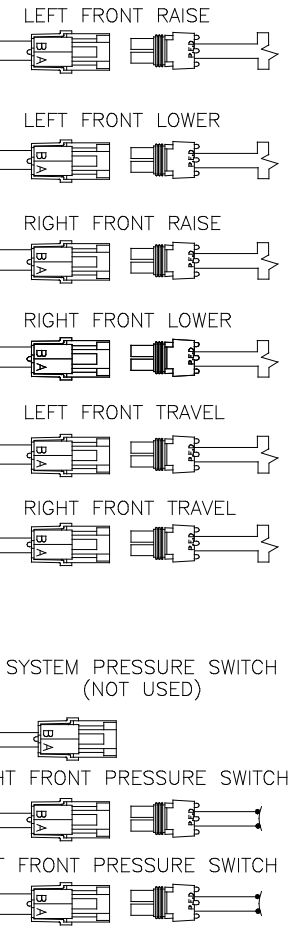

OEM PROVIDED

NOTE: INSTALLATION MUST CONFORM TO GOOD SHOP PRACTICES, SAE STANDARDS, RVIA STANDARDS, AND OTHER APPLICABLE STANDARDS.

MP90681 F  
 16AUG11

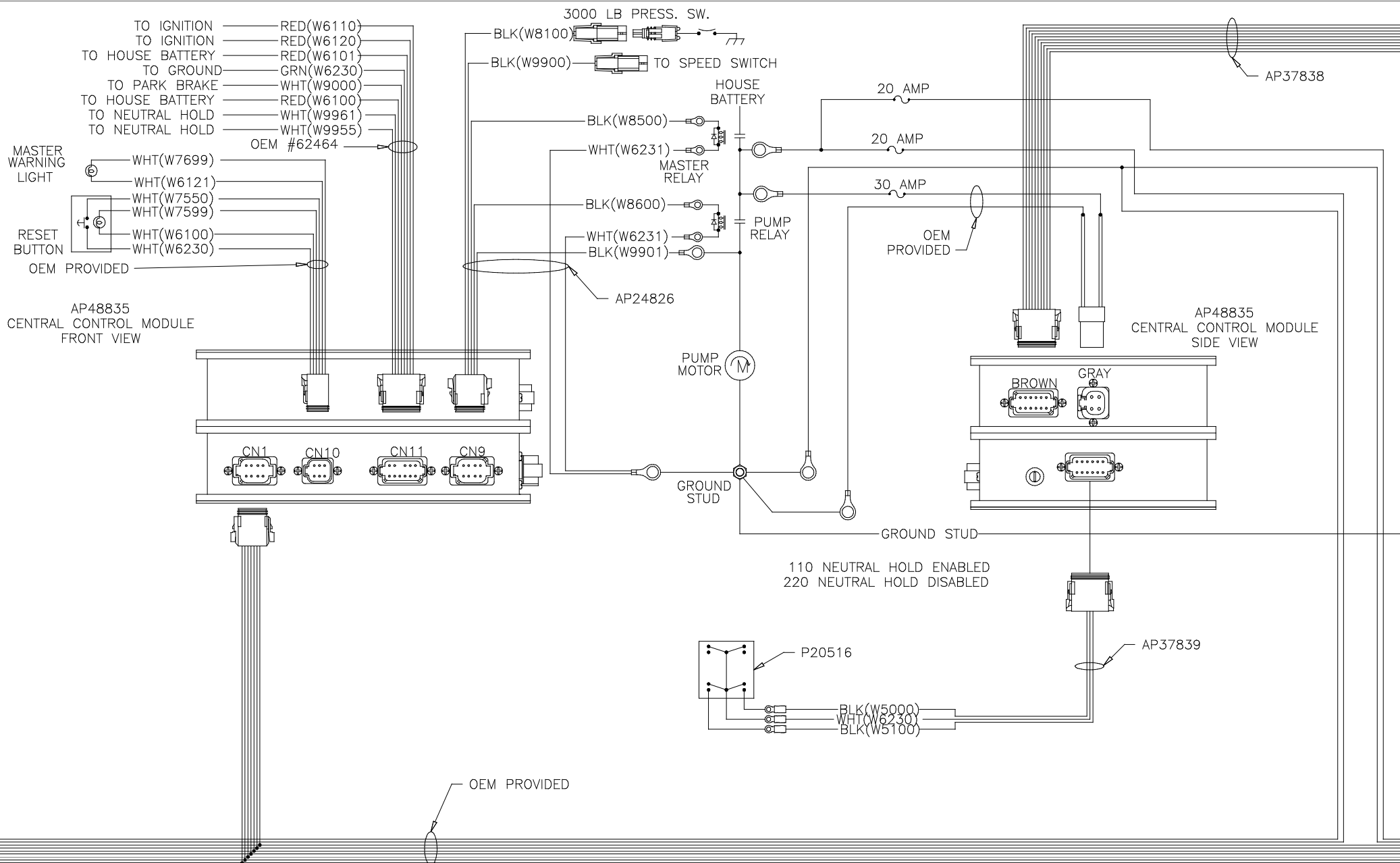

NOTE: INSTALLATION MUST CONFORM TO GOOD SHOP PRACTICES, SAE STANDARDS, RVIA STANDARDS, AND OTHER APPLICABLE STANDARDS.

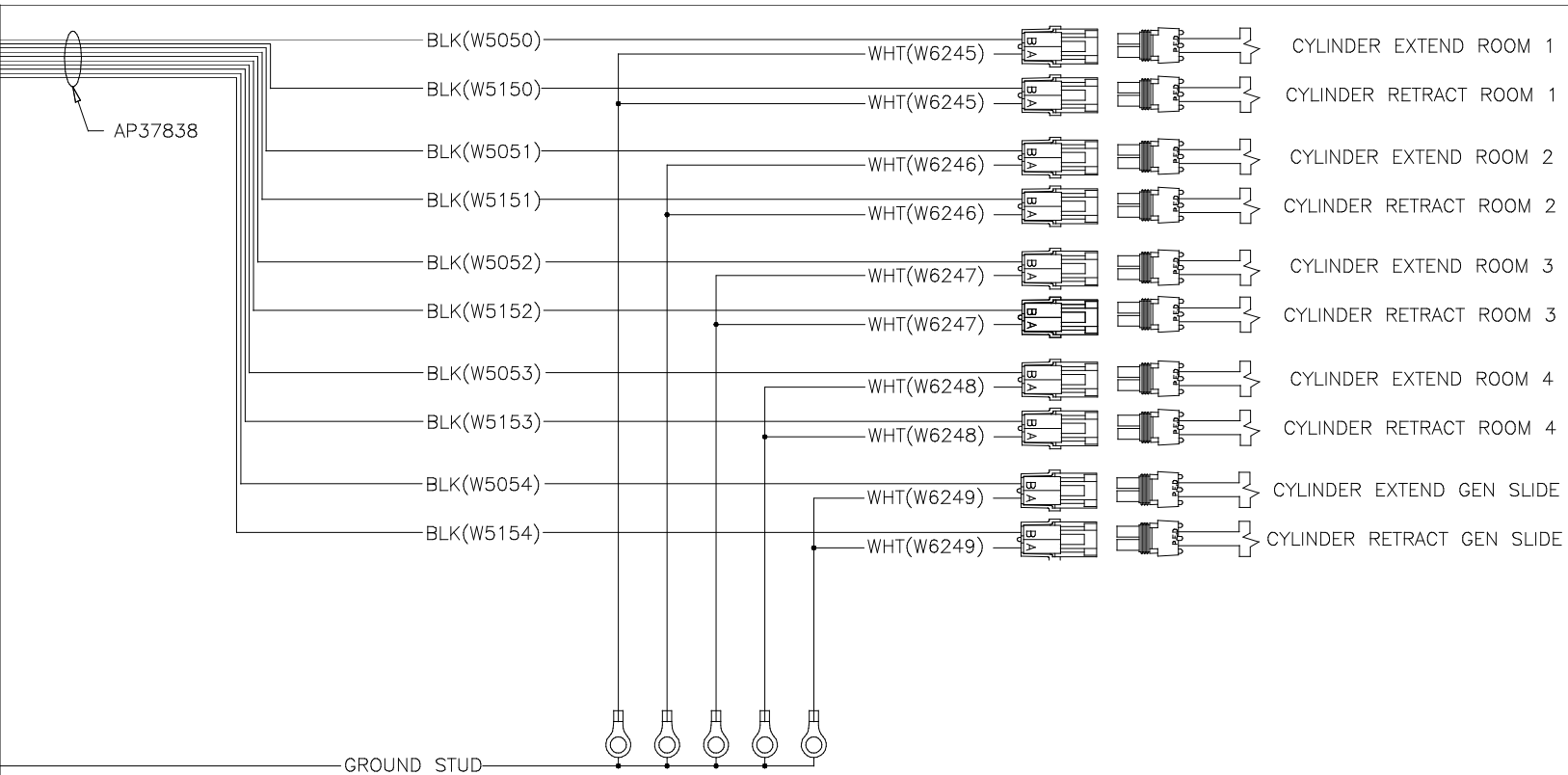

OEM PROVIDED

NOTE: INSTALLATION MUST CONFORM TO GOOD SHOP PRACTICES, SAE STANDARDS, RVIA STANDARDS, AND OTHER APPLICABLE STANDARDS.

MP90681 H  
13AUG12



AP34263  
REAR AIR/ROOM 2 & 3 MODULE

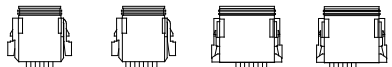
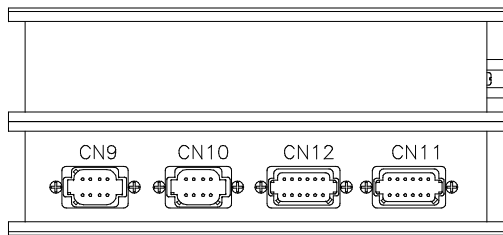

AP34268

- BLK(W4210)
- BLK(W3210)
- WHT(W6232)
- BLK(W3215)
- WHT(W6231)
- BLK(W3211)
- BLK(W4211)

- BLKW5600
- BLK(W5650)
- BLKW5601
- BLK(W5651)

- BLK(W5652)
- WHT(W6232)
- BLK(W5651)
- WHT(W6231)

- BLK(W5700)
- BLK(W6801)
- WHT(W6232)
- BLK(W5702)
- BLK(W6801)
- WHT(W6232)

- BLK(W5701)
- BLK(W6800)
- WHT(W6231)
- BLK(W5703)
- BLK(W6800)
- WHT(W6231)

- WHT(W6230) AIR SEAL ROOM 3
- WHT(W6230) VACUUM ROOM 3
- WHT(W6230) AIR SEAL ROOM 2
- WHT(W6230) VACUUM ROOM 2

- VACUUM PRESSURE SENSE ROOM 3
- VACUUM PRESSURE SENSE ROOM 2

- ROOM OUT ROOM 3
- ROOM IN ROOM 3

- ROOM OUT ROOM 2
- ROOM IN ROOM 2

PART OF AP34268

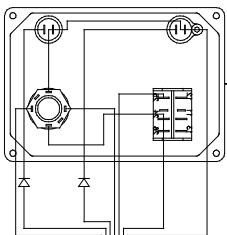

AP22475

OEM PROVIDED ROOM SELECTOR SWITCH



OEM PROVIDED

OEM PROVIDED

NOTE: INSTALLATION MUST CONFORM TO GOOD SHOP PRACTICES, SAE STANDARDS, RVIA STANDARDS, AND OTHER APPLICABLE STANDARDS.

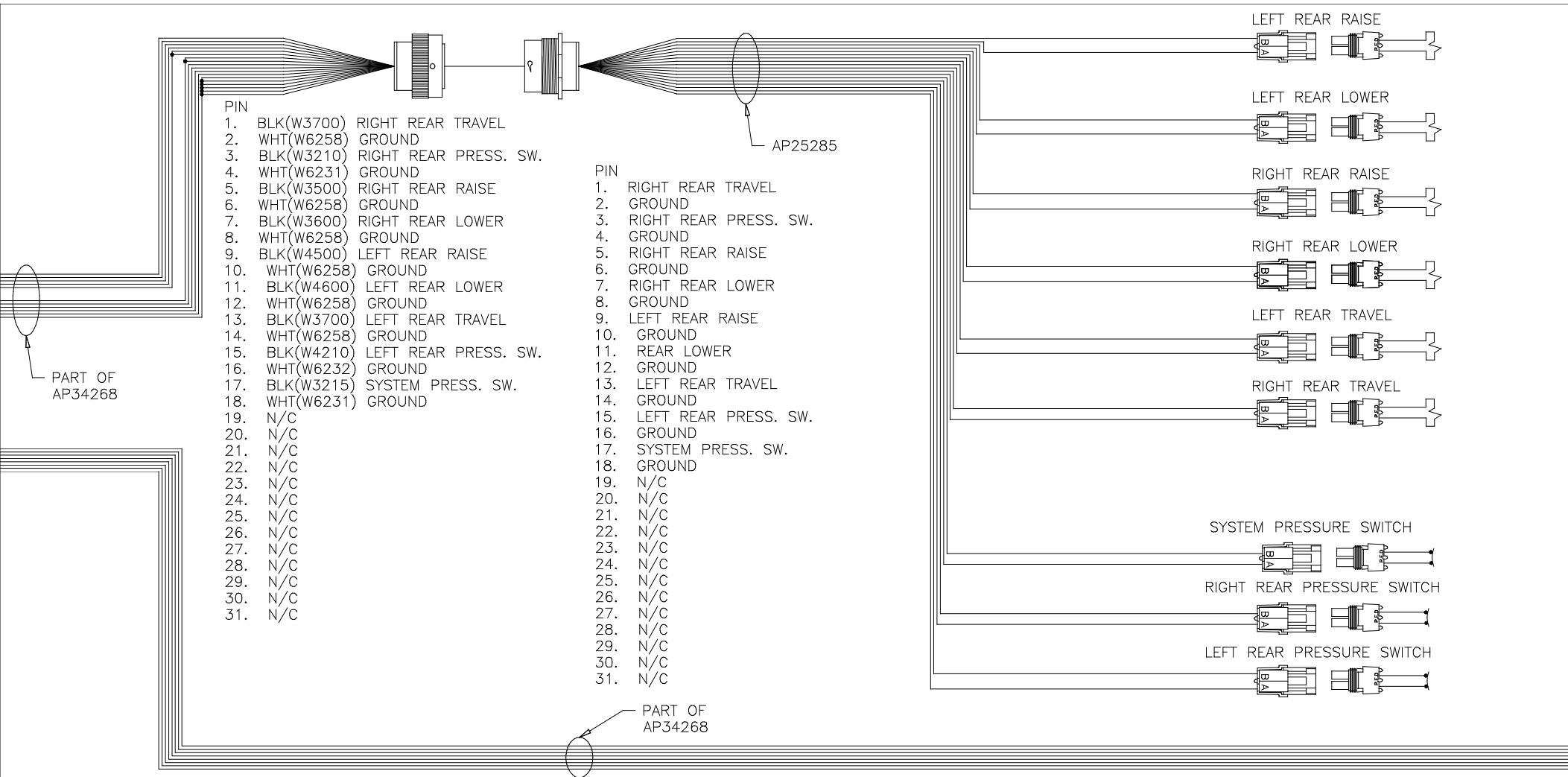

NOTE: INSTALLATION MUST CONFORM TO GOOD SHOP PRACTICES, SAE STANDARDS, RVIA STANDARDS, AND OTHER APPLICABLE STANDARDS.

- PIN
1. BLK(W3701) TAG RIGHT SIDE TRAVEL
  2. WHT(W6258) GROUND
  3. BLK(W3211) TAG RIGHT SIDE PRESS. SW.
  4. WHT(W6231) GROUND
  5. BLK(W3800) TAG LIFT
  6. WHT(W6258) GROUND
  7. BLK(W3601) TAG RIGHT SIDE DUMP
  8. WHT(W6258) GROUND
  9. BLK(W3701) TAG LIFT EXHAUST
  10. WHT(W6258) GROUND
  11. BLK(W4601) TAG LEFT SIDE DUMP
  12. WHT(W6258) GROUND
  13. BLK(W3701) TAG LEFT SIDE TRAVEL
  14. WHT(W6258) GROUND
  15. BLK(W4211) TAG LEFT SIDE PRESS. SW.
  16. WHT(W6231) GROUND
  17. N/C
  18. N/C
  19. N/C
  20. N/C
  21. N/C
  22. N/C
  23. N/C
  24. N/C
  25. N/C
  26. N/C
  27. N/C
  28. N/C
  29. N/C
  30. N/C
  31. N/C

TAG AXLE  
AIR MANIFOLD  
CONNECTIONS

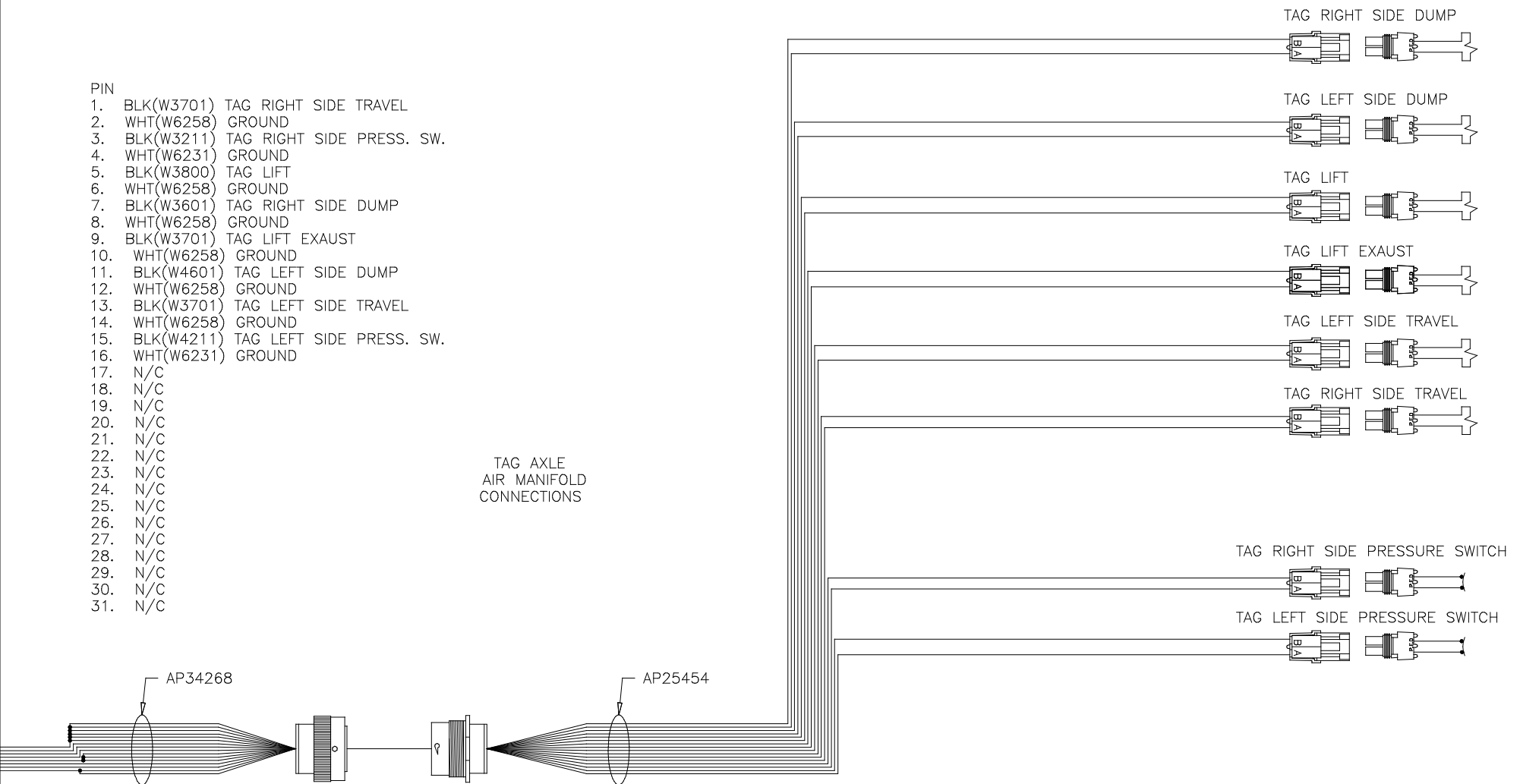

NOTE: INSTALLATION MUST CONFORM TO GOOD SHOP PRACTICES, SAE STANDARDS, RVIA STANDARDS, AND OTHER APPLICABLE STANDARDS.

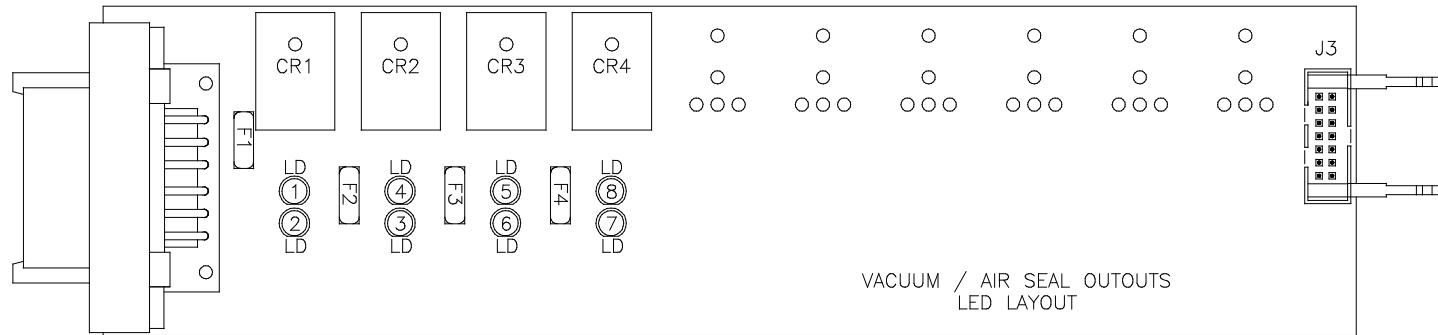

FRONT MODULE (AP34262)						
LED #	COLOR	INPUT J3	FUSE #	OUTPUT	RELAY #	DESCRIPTION
LED1	YELLOW	PIN 13	---	---	CR1	VACUUM (COIL) ROOM 1
LED2	RED	---	FUSE 1	PIN 1	CR1	VACUUM (CONTACT) ROOM 1
LED3	RED	---	FUSE 2	PIN 2	CR2	AIR SEAL (CONTACT) ROOM 1
LED4	YELLOW	PIN 12	---	---	CR2	AIR SEAL (COIL) ROOM 1
LED5	YELLOW	PIN 11	---	---	CR3	VACUUM (COIL) ROOM 4
LED6	RED	---	FUSE 3	PIN 3	CR3	VACUUM (CONTACT) ROOM 4
LED7	RED	---	FUSE 4	PIN 4	CR4	AIR SEAL (CONTACT) ROOM 4
LED8	YELLOW	PIN 10	---	---	CR4	AIR SEAL (COIL) ROOM 4

REAR MODULE (AP34263)						
LED #	COLOR	INPUT J3	FUSE #	OUTPUT	RELAY #	DESCRIPTION
LED1	YELLOW	PIN 13	---	---	CR1	VACUUM (COIL) ROOM 2
LED2	RED	---	FUSE 1	PIN 1	CR1	VACUUM (CONTACT) ROOM 2
LED3	RED	---	FUSE 2	PIN 2	CR2	AIR SEAL (CONTACT) ROOM 2
LED4	YELLOW	PIN 12	---	---	CR2	AIR SEAL (COIL) ROOM 2
LED5	YELLOW	PIN 11	---	---	CR3	VACUUM (COIL) ROOM 3
LED6	RED	---	FUSE 3	PIN 3	CR3	VACUUM (CONTACT) ROOM 3
LED7	RED	---	FUSE 4	PIN 4	CR4	AIR SEAL (CONTACT) ROOM 3
LED8	YELLOW	PIN 10	---	---	CR4	AIR SEAL (COIL) ROOM 3

NOTE: INSTALLATION MUST CONFORM TO GOOD SHOP PRACTICES, SAE STANDARDS, RVIA STANDARDS, AND OTHER APPLICABLE STANDARDS.

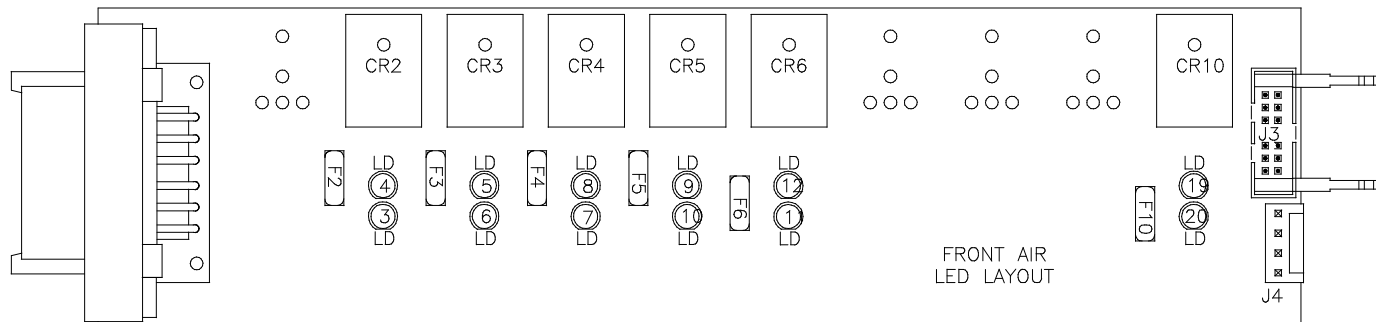

LED #	COLOR	INPUT J3	FUSE #	OUTPUT	RELAY #	DESCRIPTION
LED3	RED	---	FUSE 2	PIN 2	CR2	LEFT FRONT RAISE (CONTACT)
LED4	YELLOW	PIN 12	---	---	CR2	LEFT FRONT RAISE (COIL)
LED5	YELLOW	PIN 11	---	---	CR3	LEFT FRONT LOWER (COIL)
LED6	RED	---	FUSE 3	PIN 3	CR3	LEFT FRONT LOWER (CONTACT)
LED7	RED	---	FUSE 4	PIN 4	CR4	RIGHT FRONT RAISE (CONTACT)
LED8	YELLOW	PIN 10	---	---	CR4	RIGHT FRONT RAISE (COIL)
LED9	YELLOW	PIN 9	---	---	CR5	RIGHT FRONT LOWER (COIL)
LED10	RED	---	FUSE 5	PIN 5	CR5	RIGHT FRONT LOWER (CONTACT)
LED11	RED	---	FUSE 6	PIN 6	CR6	COMPRESSOR (CONTACT)
LED12	YELLOW	PIN 8	---	---	CR6	COMPRESSOR (COIL)
LED19	YELLOW	PIN 4	---	---	CR10	TRAVEL (COIL)
LED20	RED	---	FUSE 10	PIN 8	CR10	TRAVEL (CONTACT)

NOTE: INSTALLATION MUST CONFORM TO GOOD SHOP PRACTICES, SAE STANDARDS, RVIA STANDARDS, AND OTHER APPLICABLE STANDARDS.

MP90681 M  
16AUG11

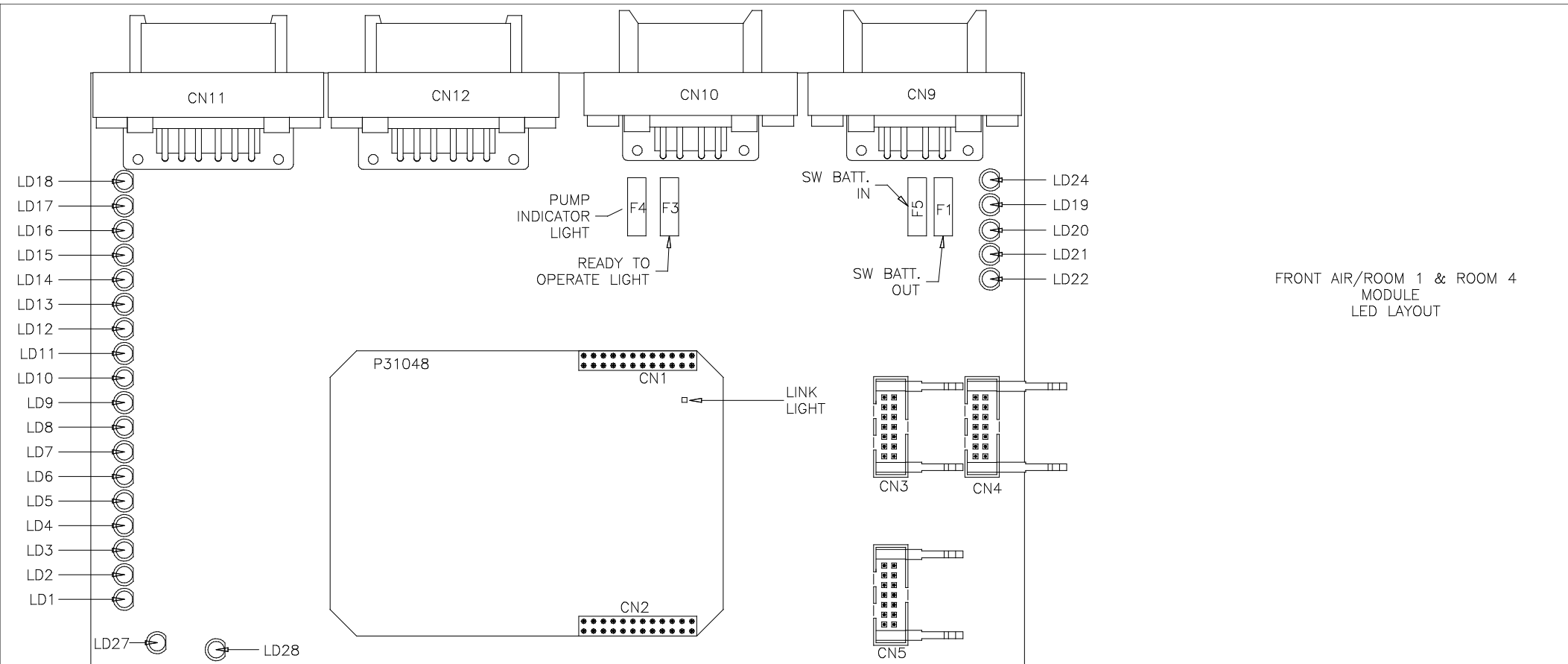

FRONT AIR/ROOM 1 & ROOM 4  
MODULE  
LED LAYOUT

LED #	CONNECTOR	COLOR	DESCRIPTION	LED #	CONNECTOR	COLOR	DESCRIPTION
LED 1	CN10 PIN 4	RED	EXTEND	LED 11	CN11 PIN 1	YELLOW	ROOM 4 VAC SNS
LED 2	CN10 PIN 5	RED	RETRACT	LED 12	NOT USED	YELLOW	NOT USED
LED 3	CN12 PIN 8	GREEN	ROOM 1 VAC SNS	LED 13	NOT USED	YELLOW	NOT USED
LED 4	NOT USED	YELLOW	NOT USED	LED 14	CN10 PIN 1	YELLOW	ROOM SELECT
LED 5	CN11 PIN 2	YELLOW	ROOM 4 RM OUT	LED 15	NOT USED	GREEN	NOT USED
LED 6	CN12 PIN 2	YELLOW	ROOM 1 RM OUT	LED 16	NOT USED	GREEN	NOT USED
LED 7	CN11 PIN 3	GREEN	ROOM 4 RM IN	LED 17	NOT USED	GREEN	NOT USED
LED 8	CN12 PIN 3	GREEN	ROOM 1 RM IN	LED 18	NOT USED	GREEN	NOT USED
LED 9	CN11 PIN 10	GREEN	LEFT FRONT PSW	LED 19	CN11/CN12 PIN 7	RED	12V OUTPUT
LED 10	CN12 PIN 10	GREEN	RIGHT FRONT PSW	LED 20	CN9 PIN 3	RED	SW BATT
				LED 21	CN10 PIN 3	RED	PUMP INDICATOR
				LED 22	CN10 PIN 2	RED	READY TO OPERATE
				LED 24	CN10 PIN 7	RED	SYSTEM WAKE UP
				LED 27	NOT USED	RED	NOT USED
				LED 28	CN12 PIN 11	RED	TAG DUMP

NOTE: INSTALLATION MUST CONFORM TO GOOD SHOP PRACTICES, SAE STANDARDS, RVIA STANDARDS, AND OTHER APPLICABLE STANDARDS.

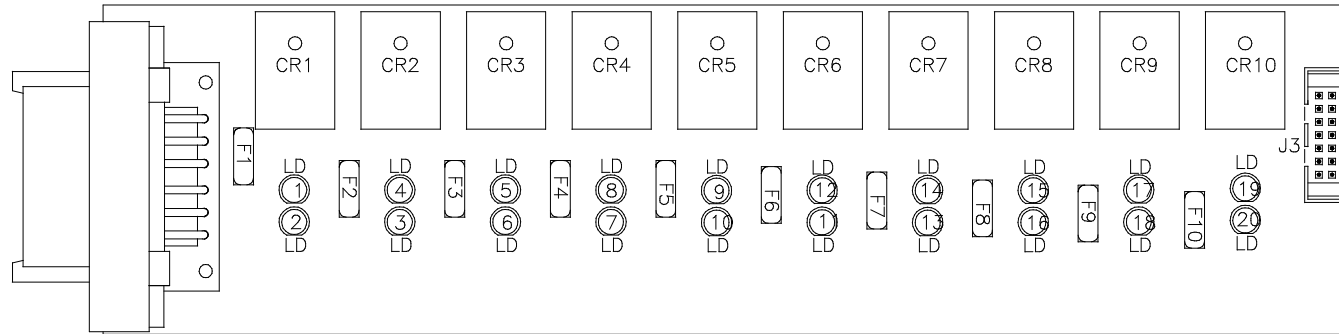

ROOM HYDRAULIC OUTPUT  
LED LAYOUT

LED #	COLOR	INPUT J3	FUSE #	OUTPUT	RELAY #	DESCRIPTION
LED1	YELLOW	PIN 13	---	---	CR1	EXTEND CYL. 1 (COIL)
LED2	RED	---	FUSE 1	PIN 1	CR1	EXTEND CYL. 1 (CONTACT)
LED3	RED	---	FUSE 2	PIN 2	CR2	RETRACT CYL. 1 (CONTACT)
LED4	YELLOW	PIN 12	---	---	CR2	RETRACT CYL. 1 (COIL)
LED5	YELLOW	PIN 11	---	---	CR3	EXTEND CYL. 2 (COIL)
LED6	RED	---	FUSE 3	PIN 3	CR3	EXTEND CYL. 2 (CONTACT)
LED7	RED	---	FUSE 4	PIN 4	CR4	RETRACT CYL. 2 (CONTACT)
LED8	YELLOW	PIN 10	---	---	CR4	RETRACT CYL. 2 (COIL)
LED9	YELLOW	PIN 9	---	---	CR5	EXTEND CYL. 3 (COIL)
LED10	RED	---	FUSE 5	PIN 5	CR5	EXTEND CYL. 3 (CONTACT)
LED11	RED	---	FUSE 6	PIN 6	CR6	RETRACT CYL. 3 (CONTACT)
LED12	YELLOW	PIN 8	---	---	CR6	RETRACT CYL. 3 (COIL)
LED13	RED	---	FUSE 7	PIN 10	CR7	EXTEND CYL. 4 (CONTACT)
LED14	YELLOW	PIN 7	---	---	CR7	EXTEND CYL. 4 (COIL)
LED15	YELLOW	PIN 6	---	---	CR8	RETRACT CYL. 4 (COIL)
LED16	RED	---	FUSE8	PIN 9	CR8	RETRACT CYL. 4 (CONTACT)
LED17	YELLOW	PIN 5	---	---	CR9	EXTEND GEN CYL. (COIL)
LED18	RED	---	FUSE 9	PIN 7	CR9	EXTEND GEN CYL. (CONTACT)
LED19	YELLOW	PIN 4	---	---	CR10	RETRACT GEN CYL. (COIL)
LED20	RED	---	FUSE 10	PIN 8	CR10	RETRACT GEN CYL. (CONTACT)

NOTE: INSTALLATION MUST CONFORM TO GOOD SHOP PRACTICES, SAE STANDARDS, RVIA STANDARDS, AND OTHER APPLICABLE STANDARDS.

MP90681 0  
16AUG11

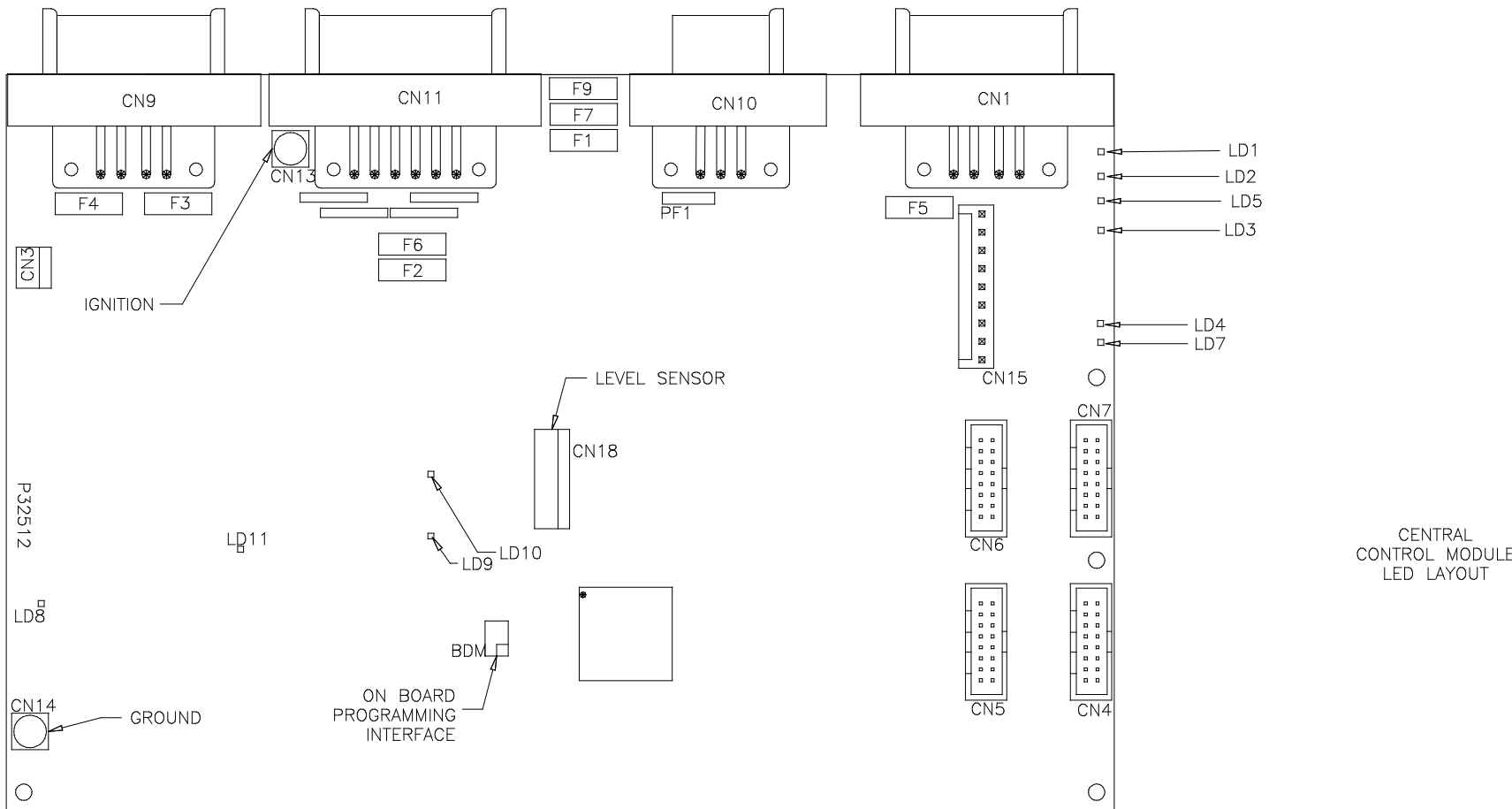

CENTRAL CONTROL MODULE LED LAYOUT

LED #	CONNECTOR	COLOR	DESCRIPTION
LED 1	CN 9 PIN 1	RED	MASTER RELAY
LED 2	CN 9 PIN 4	RED	PUMP RELAY
LED 3	CN 1 PIN 3	RED	SW 12V
LED 4	CN 11 PIN 12	RED	ENGINE BATT
LED 5	CN 9 PIN 5	RED	SPEED SWITCH
LED 7	CN 1 PIN 7 & 8	RED	LINK LIGHT
LED 8	CN 11 PIN 8 & 9	RED	NEUTRAL HOLD
LED 9	NOT USED	NOT USED	NOT USED
LED 10	CN9 PIN 2	RED	3000 LBS. PSW
LED 11	CN11 PIN 11	RED	PARK BRAKE

FUSE #	DESCRIPTION
PF1	RESET OUT
F7	ACCESSORY
F1	IGNITION
F2	HOUSE BATTERY
F3	MASTER RELAY
F4	PUMP RELAY
F5	SW. BATT TO CAN MODULES
F6	ENGINE BATTERY
F9	POWER TO CN100

NOTE: INSTALLATION MUST CONFORM TO GOOD SHOP PRACTICES, SAE STANDARDS, RVIA STANDARDS, AND OTHER APPLICABLE STANDARDS.



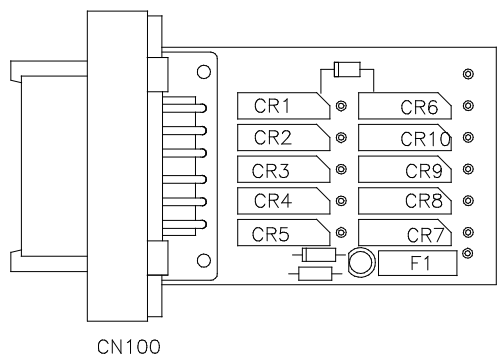

GENERATOR SLIDE  
 REED SWITCH  
 LAYOUT

CONNECTOR	REED SWITCH	DESCRIPTION
CN 100 PIN 1	CR1	GEN SLIDE EXTEND
CN 100 PIN 2	CR2	NOT USED
CN 100 PIN 3	CR3	NOT USED
CN 100 PIN 4	CR4	NOT USED
CN 100 PIN 5	CR5	NOT USED
CN 100 PIN 6	---	GROUND

CONNECTOR	REED SWITCH	DESCRIPTION
CN 100 PIN 7	---	NOT USED
CN 100 PIN 8	CR7	NOT USED
CN 100 PIN 9	CR8	NOT USED
CN 100 PIN 10	CR9	NOT USED
CN 100 PIN 11	CR10	NOT USED
CN 100 PIN 12	CR6	GEN SLIDE RETRACT

NOTE: INSTALLATION MUST CONFORM TO GOOD SHOP PRACTICES, SAE STANDARDS, RVIA STANDARDS, AND OTHER APPLICABLE STANDARDS.

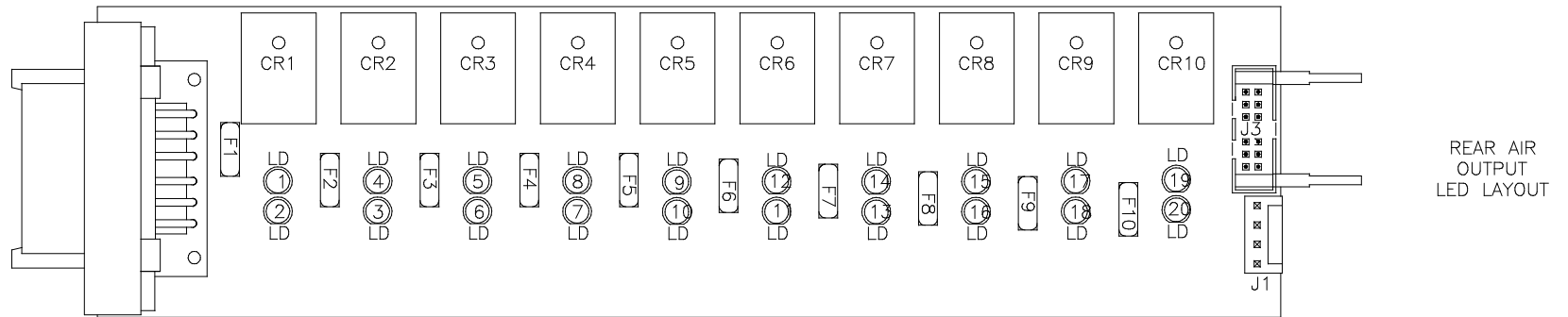

LED #	COLOR	INPUT J3	FUSE #	OUTPUT	RELAY #	DESCRIPTION
LED1	YELLOW	PIN 13	---	---	CR1	TAG LIFT (COIL)
LED2	RED	---	FUSE 1	PIN 1	CR1	TAG LIFT (CONTACT)
LED3	RED	---	FUSE 2	PIN 2	CR2	LEFT REAR RAISE (CONTACT)
LED4	YELLOW	PIN 12	---	---	CR2	LEFT REAR RAISE (COIL)
LED5	YELLOW	PIN 11	---	---	CR3	LEFT REAR LOWER (COIL)
LED6	RED	---	FUSE 3	PIN 3	CR3	LEFT REAR LOWER (CONTACT)
LED7	RED	---	FUSE 4	PIN 4	CR4	RIGHT REAR RAISE (CONTACT)
LED8	YELLOW	PIN 10	---	---	CR4	RIGHT REAR RAISE (COIL)
LED9	YELLOW	PIN 9	---	---	CR5	RIGHT REAR LOWER (COIL)
LED10	RED	---	FUSE 5	PIN 5	CR5	RIGHT REAR LOWER (CONTACT)
LED11	RED	---	FUSE 6	PIN 6	CR6	NOT USED
LED12	YELLOW	PIN 8	---	---	CR6	NOT USED
LED13	RED	---	FUSE 7	PIN 10	CR7	TAG LEFT REAR LOWER (CONTACT)
LED14	YELLOW	PIN 7	---	---	CR7	TAG LEFT REAR LOWER (COIL)
LED15	YELLOW	PIN 6	---	---	CR8	TAG RIGHT REAR LOWER (COIL)
LED16	RED	---	FUSE8	PIN 9	CR8	TAG RIGHT REAR LOWER (CONTACT)
LED17	YELLOW	PIN 5	---	---	CR9	TAG TRAVEL (COIL)
LED18	RED	---	FUSE 9	PIN 7	CR9	TAG TRAVEL (CONTACT)
LED19	YELLOW	PIN 4	---	---	CR10	TRAVEL (COIL)
LED20	RED	---	FUSE 10	PIN 8	CR10	TRAVEL (CONTACT)

REAR AIR  
OUTPUT  
LED LAYOUT

NOTE: INSTALLATION MUST CONFORM TO GOOD SHOP PRACTICES, SAE STANDARDS, RVIA STANDARDS, AND OTHER APPLICABLE STANDARDS.

MP90681 R  
16AUG11

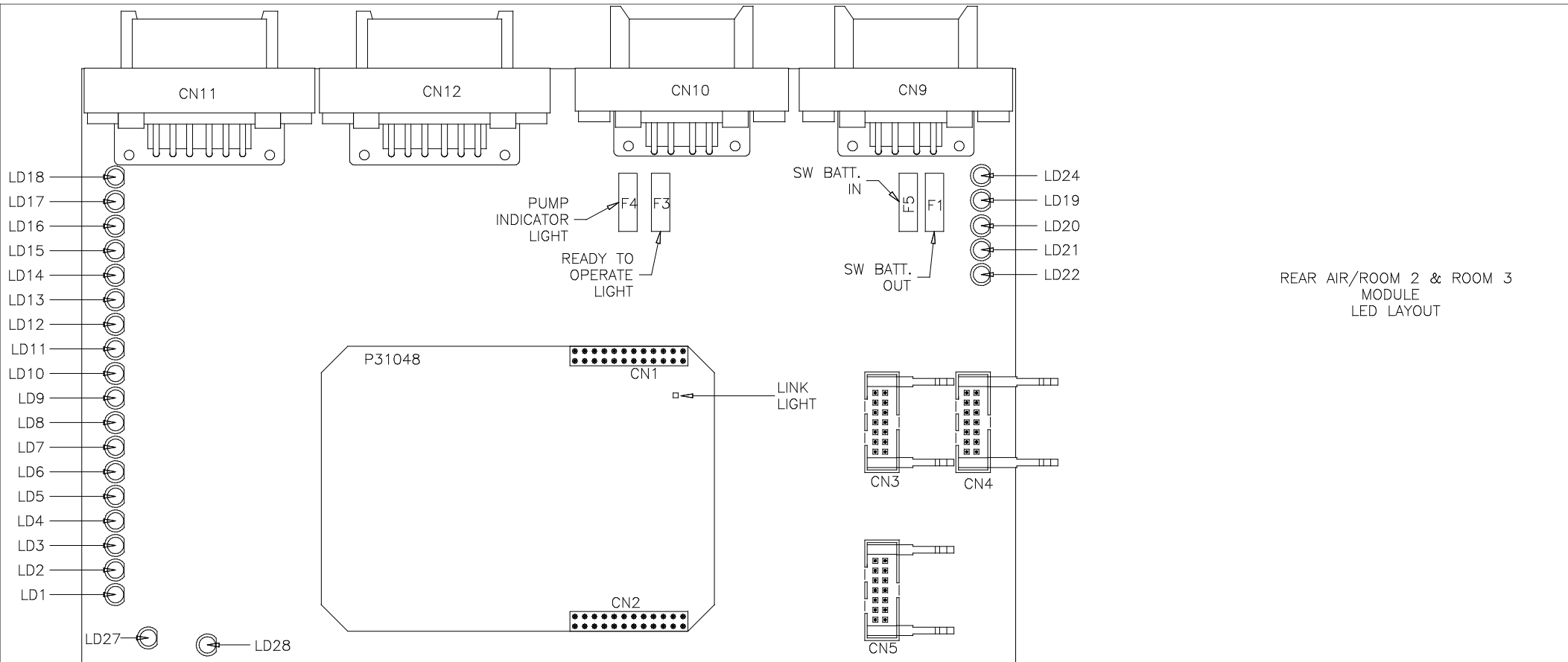

REAR AIR/ROOM 2 & ROOM 3  
MODULE  
LED LAYOUT

LED #	CONNECTOR	COLOR	DESCRIPTION
LED 1	CN10 PIN 4	RED	EXTEND
LED 2	CN10 PIN 5	RED	RETRACT
LED 3	CN12 PIN 8	GREEN	ROOM 2 VAC SNS
LED 4	NOT USED	YELLOW	NOT USED
LED 5	CN11 PIN 2	YELLOW	ROOM 3 RM OUT
LED 6	CN12 PIN 2	YELLOW	ROOM 2 RM OUT
LED 7	CN11 PIN 3	GREEN	ROOM 3 RM IN
LED 8	CN12 PIN 3	GREEN	ROOM 2 RM IN
LED 9	NOT USED	GREEN	NOT USED
LED 10	NOT USED	GREEN	NOT USED

LED #	CONNECTOR	COLOR	DESCRIPTION
LED 11	CN11 PIN 1	YELLOW	ROOM 3 VAC SNS
LED 12	CN12 PIN 1	YELLOW	LEFT REAR TAG PSW
LED 13	NOT USED	YELLOW	NOT USED
LED 14	CN10 PIN 1	YELLOW	ROOM SELECT
LED 15	CN11 PIN 4	GREEN	RIGHT REAR AIR PSW
LED 16	CN12 PIN 4	GREEN	RIGHT REAR TAG PSW
LED 17	NOT USED	GREEN	NOT USED
LED 18	CN12 PIN9	GREEN	SYSTEM PSW
LED 19	CN11/CN12 PIN 7	RED	12V OUTPUT
LED 20	CN9 PIN 3	RED	SW BATT
LED 21	CN10 PIN 3	RED	PUMP INDICATOR
LED 22	CN10 PIN 2	RED	READY TO OPERATE
LED 24	CN10 PIN 7	RED	SYSTEM WAKE UP
LED 27	CN11 PIN 8	RED	LEFT REAR AIR PSW
LED 28	NOT USED	RED	NOT USED

NOTE: INSTALLATION MUST CONFORM TO GOOD SHOP PRACTICES, SAE STANDARDS, RVIA STANDARDS, AND OTHER APPLICABLE STANDARDS.

MP90681 S  
16AUG11