

FRONT VIEW - AP47627

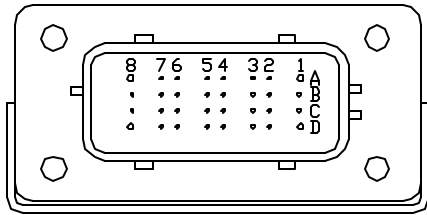

- PIN
- A1. BLK(W8601) - PUMP REQUEST
 - A2. YELLOW - CAN HIGH
 - A3. N/C
 - A4. N/C
 - A5. BLK(W2000) - RIGHT FRONT JACK WARNING SWITCH
 - A6. BLK(W2200) - RIGHT FRONT JACK PRESSURE SWITCH
 - A7. BLK(W3200) - RIGHT REAR JACK PRESSURE SWITCH
 - A8. BLK(W8101) - 50 LB. PRESSURE SWITCH
 - B1. RED(W6800) - TOUCH PANEL POWER
 - B2. GREEN - CAN LOW
 - B3. WHT(W6230) - TOUCH PANEL GROUND
 - B4. N/C
 - B5. BLK(W3000) - RIGHT REAR JACK WARNING SWITCH
 - B6. BLK(W4200) - LEFT REAR JACK PRESSURE SWITCH
 - B7. N/C
 - B8. BLK(W8100) - 3000 LB. PRESSURE SWITCH
 - C1. RED(W6121) - LEVEL SENSOR POWER
 - C2. CAN SHIELD
 - C3. WHT(W6231) - LEVEL SENSOR GROUND
 - C4. BLK(W0400) - REAR SENSE
 - C5. BLK(W4000) - LEFT REAR JACK WARNING SWITCH
 - C6. N/C
 - C7. N/C
 - C8. BLK(W0300) - RIGHT SIDE SENSE
 - D1. RED(W6120) - ACCESSORY
 - D2. WHT(W6235) - WARNING SWITCH GROUND
 - D3. N/C
 - D4. BLK(W1000) - LEFT FRONT JACK WARNING SWITCH
 - D5. BLK(W1200) - LEFT FRONT JACK PRESSURE SWITCH
 - D6. BLK(W0100) - LEFT SIDE SENSE
 - D7. BLK(W0200) - FRONT SENSE
 - D8. BLK(W9000) - PARK BRAKE
- NOTE: WIRE NUMBERS ON THIS SHEET ARE REFERENCED TO HARNESS PLUGS.

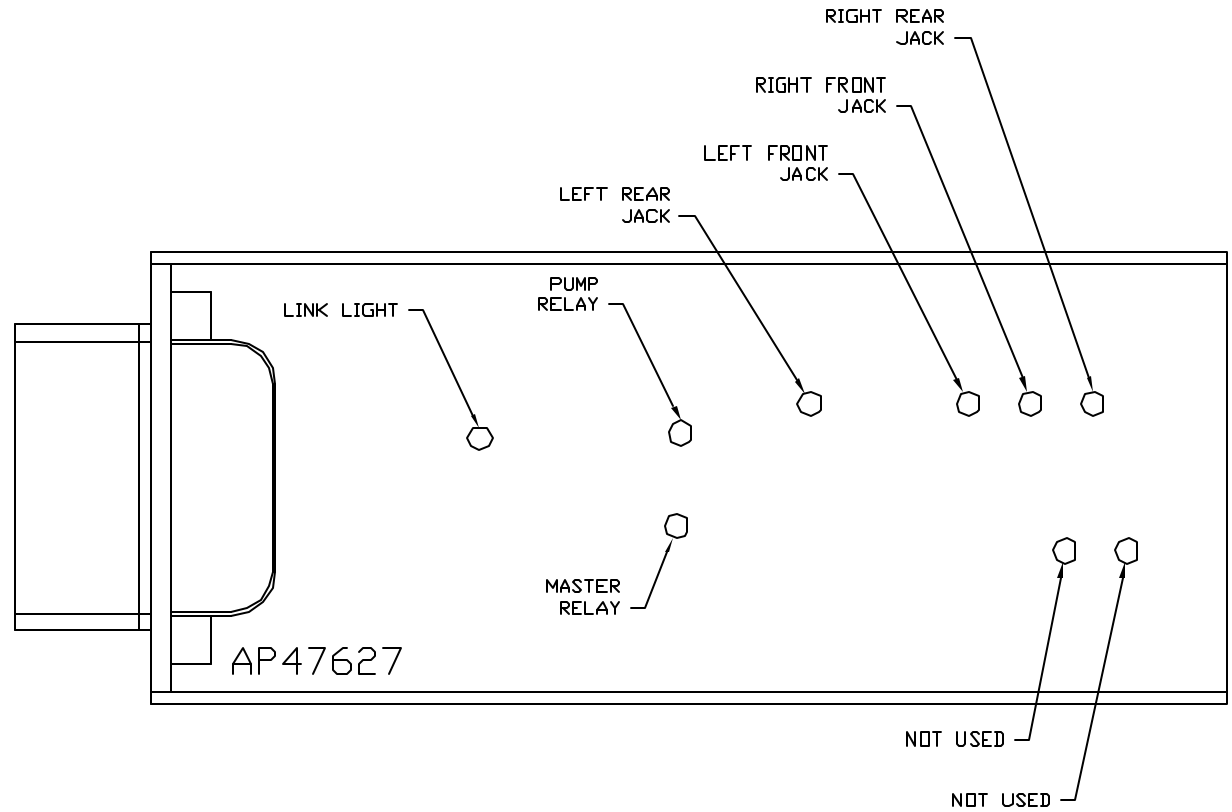

NOTE: INSTALLATION MUST CONFORM TO GOOD SHOP PRACTICES, SAE STANDARDS, RVIA STANDARDS, AND OTHER APPLICABLE STANDARDS.

		HWH		I-80 EXIT 267 SOUTH RT 1 MOSCOW, IOWA 52760	
		SCALE 1:3	DATE 24FEB12	DRAWN BY .	
		SYSTEM SCHEMATIC ELEC			
NO.	DATE	REVISION			
		THE INFORMATION DISCLOSED ON THIS DRAWING IS CONFIDENTIAL AND MUST NOT BE DISCLOSED OR USED IN ANY MANNER WHICH WILL BE DETRIMENTAL TO THE HWH CORPORATION			
				DRAWING NUMBER MP90734 A/D	

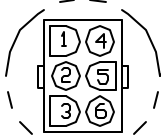

DETAIL A

- PIN
- 1. N/C
 - 2. N/C
 - 3. N/C
 - 4. N/C
 - 5. BLK(W7699) WARNING LED/ALARM CONTROL
 - 6. N/C

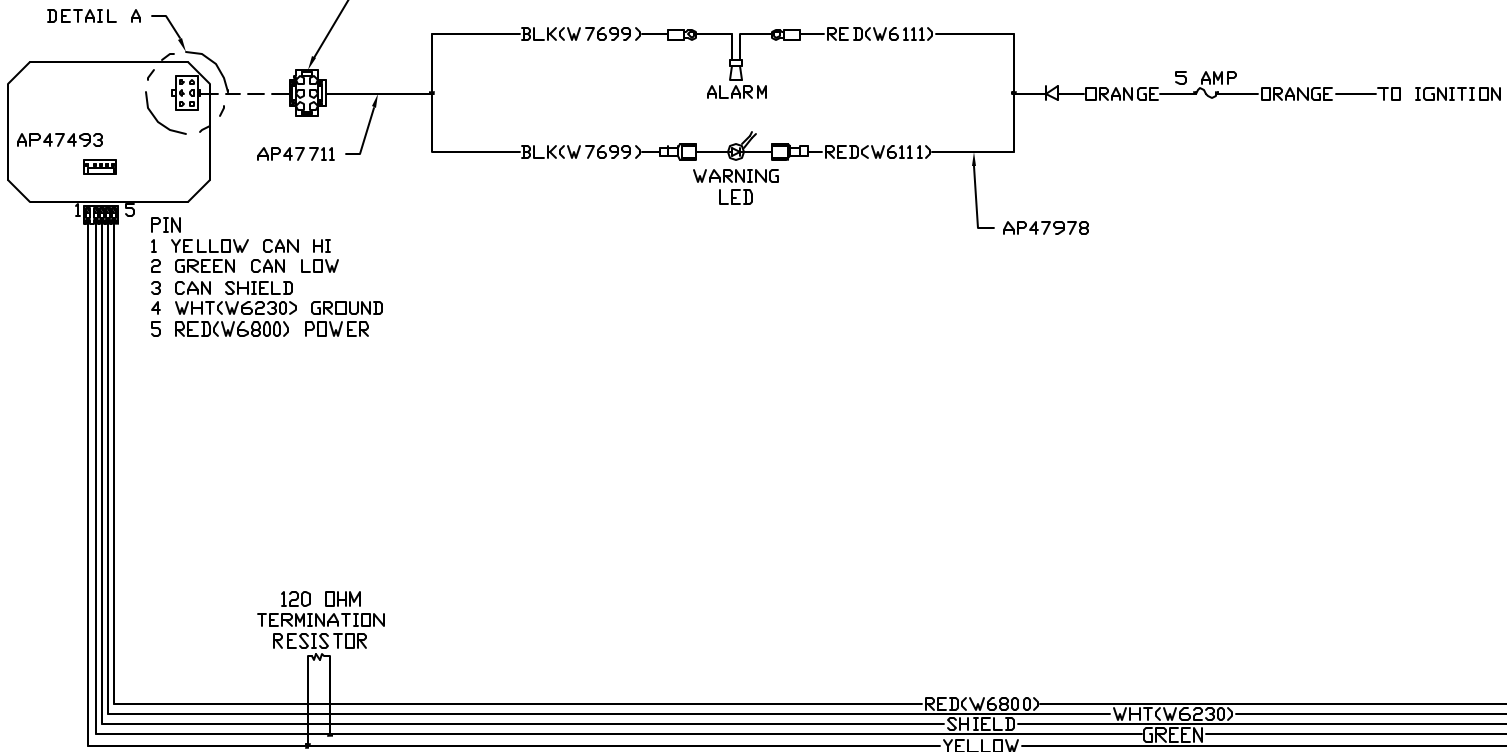

NOTE: INSTALLATION MUST CONFORM TO GOOD SHOP PRACTICES, SAE STANDARDS, RVIA STANDARDS, AND OTHER APPLICABLE STANDARDS.

AP49720

MP90734 B
24FEB12

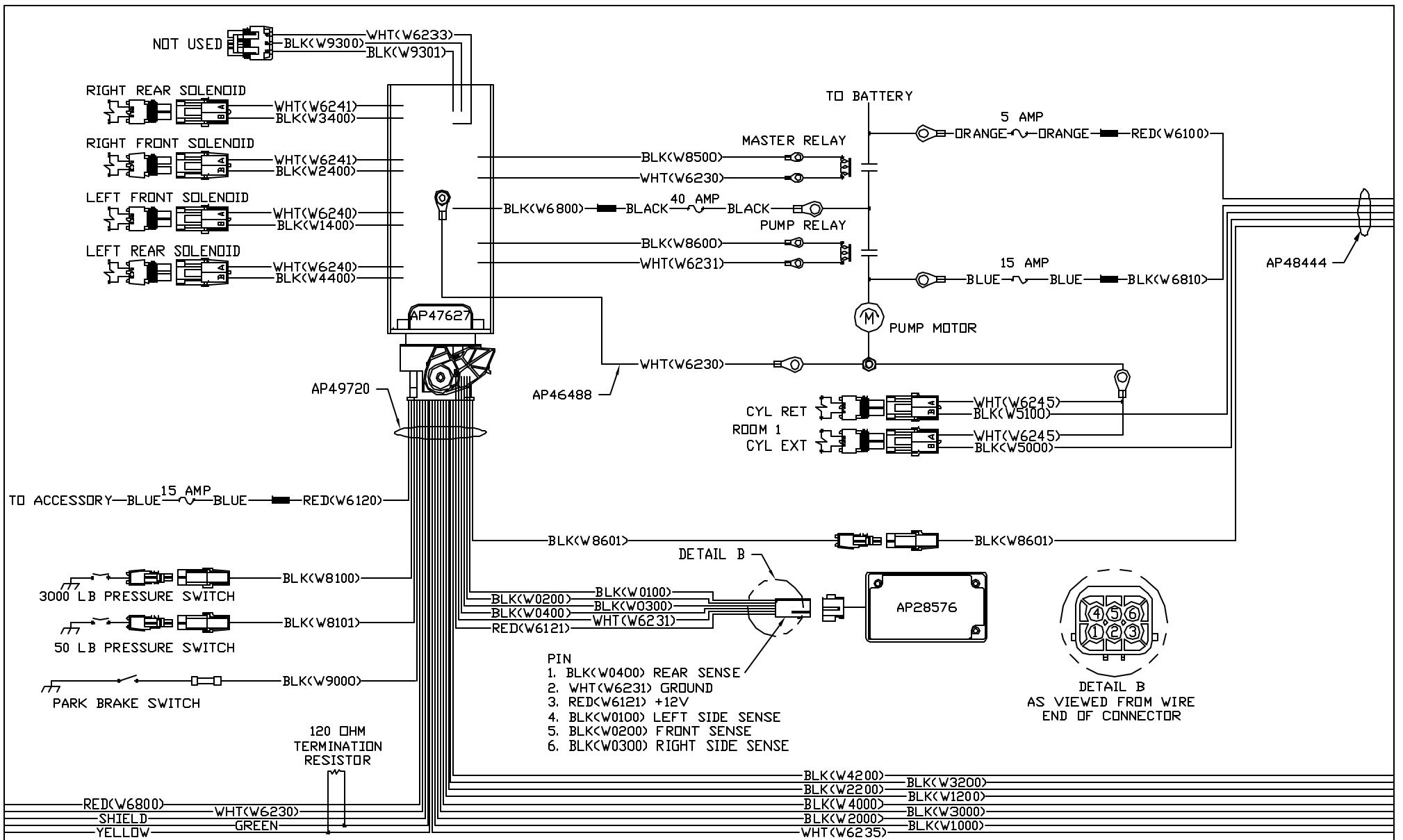

NOTE: INSTALLATION MUST CONFORM TO GOOD SHOP PRACTICES, SAE STANDARDS, RVIA STANDARDS, AND OTHER APPLICABLE STANDARDS.

