

AP42581  
FRONT ACTIVE AIR INPUT/OUTPUT MODULE

LEFT SIDE

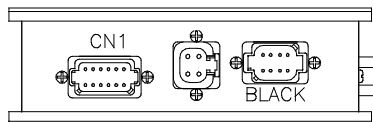

FRONT

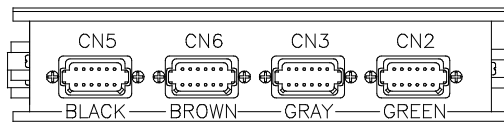

RIGHT SIDE

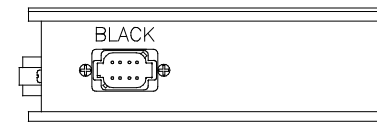

AP38815 CN1 (BROWN)

- PIN
- 1 BLK(W1500) LEFT FRONT RAISE
  - 2 BLK(W1600) LEFT FRONT LOWER
  - 3 BLK(W2500) RIGHT FRONT RAISE
  - 4 BLK(W2600) RIGHT FRONT LOWER
  - 5 BLK(W9700) COMPRESSOR
  - 6 N/C
  - 7 N/C
  - 8 N/C
  - 9 N/C
  - 10 N/C
  - 11 WHT(W6254) GROUND
  - 12 N/C

AP38815 (GRAY)

- PIN
- 1 RED(W6800) SW BATT
  - 2 RED(W6800) SW BATT
  - 3 GRN(W6230) GND
  - 4 GRN(W6230) GND

AP38815 RIGHT SIDE (BLACK)

- PIN
- 1 N/C
  - 2 N/C
  - 3 RED(W6800) SW BATTERY
  - 4 GRN(W6230) GROUND
  - 5 CAN SHIELD
  - 6 N/C
  - 7 GRN CAN LOW
  - 8 YEL CAN HI

AP38815 LEFT SIDE (BLACK)

- PIN
- 1 WHT(W7696) SYSTEM WAKE UP
  - 2 N/C
  - 3 RED(W6800) SW BATTERY
  - 4 GRN(W6230) GROUND
  - 5 CAN SHIELD
  - 6 RED(W6110) IGNITION
  - 7 GRN CAN LOW
  - 8 YEL CAN HI

AP38815 CN5 (BLACK)

- PIN
- 1 BLK(W5703) ROOM 1 ROOM IN
  - 2 BLK(W5701) ROOM 1 ROOM OUT
  - 3 BLK(W5651) ROOM 1 VACUUM SENSOR
  - 4 N/C
  - 5 N/C
  - 6 WHT(W7501) EXTEND (ROOM 1)
  - 7 WHT(W7502) RETRACT (ROOM 1)
  - 8 N/C
  - 9 N/C
  - 10 N/C
  - 11 N/C
  - 12 N/C

AP38815 CN6 (BROWN)

- PIN
- 1 BLK(W6800) SW. +12V
  - 2 N/C
  - 3 N/C
  - 4 BLK(W7510) READY TO OPERATE
  - 5 BLK(W7530) PUMP
  - 6 WHT(W6236) GROUND
  - 7 BLK(W6805) SW BATTERY
  - 8 BLK(W7696) SYSTEM WAKE UP
  - 9 N/C
  - 10 N/C
  - 11 N/C
  - 12 N/C

AP38815 CN3 (GRAY)

- PIN
- 1 BLK(W1100) RIDE HEIGHT LOW
  - 2 BLK(W1101) RIDE HEIGHT MEDIUM
  - 3 BLK(W1102) RIDE HEIGHT HIGH
  - 4 BLK(W1103) ENCODE A
  - 5 BLK(W1104) ENCODE B
  - 6 N/C
  - 7 N/C
  - 8 BLK(W7400) STEERING A
  - 9 BLK(W7401) STEERING B
  - 10 BLK(W7521) TAG LIFT
  - 11 N/C
  - 12 N/C

AP38815 CN2 (GREEN)

- PIN
- 1 RED(W6120) SW. BATT
  - 2 BLK(W6900) +5V OUTPUT
  - 3 BLK(W6901) +5V OUTPUT
  - 4 N/C
  - 5 N/C
  - 6 WHT(W6235) GROUND
  - 7 RED(W6121) SW. BATT
  - 8 N/C
  - 9 N/C
  - 10 N/C
  - 11 BLK(W2220) RIGHT FRONT TRANSDUCER
  - 12 BLK(W1220) LEFT FRONT TRANSDUCER

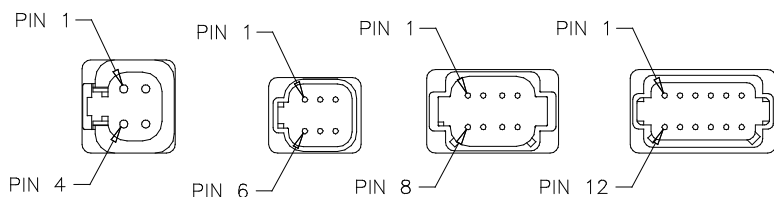

NOTE: DEUTSCH PIN NUMBERS TYPICAL UNLESS OTHERWISE NOTED

NOTE: INSTALLATION MUST CONFORM TO GOOD SHOP PRACTICES, SAE STANDARDS, RVIA STANDARDS, AND OTHER APPLICABLE STANDARDS.

		HWH		1-80 EXIT 267 SOUTH RT 1 MOSCOW, IOWA 52760	
		SCALE 1:3	DATE 18JUL12	DRAWN BY .	
		SYSTEM SCHEMATIC ELEC			
NO.	DATE	REVISION			
		THE INFORMATION DISCLOSED ON THIS DRAWING IS CONFIDENTIAL AND MUST NOT BE DISCLOSED OR USED IN ANY MANNER WHICH WILL BE DETRIMENTAL TO THE HWH CORPORATION			
				DRAWING NUMBER MP90804 A/R	

AP50566  
CENTRAL CONTROL  
MODULES

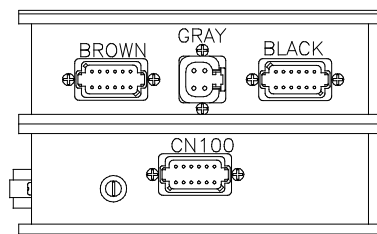
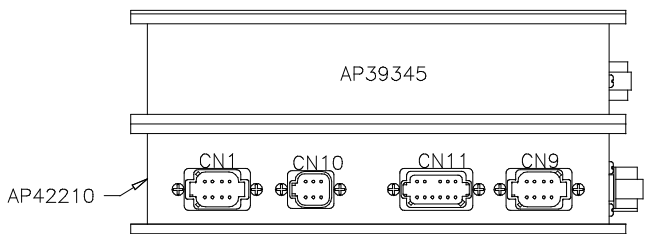

110 NEUTRAL HOLD ENABLED  
220 NEUTRAL HOLD DISABLED

AP39345 (BROWN)

PIN	FUNCTION
1	BLK(W5050) CYLINDER EXTEND 1
2	BLK(W5150) CYLINDER RETRACT 1
3	BLK(W5600) AIR SEAL ROOM 1
4	BLK(W5650) VACUUM ROOM 1
5	N/C
6	N/C
7	N/C
8	N/C
9	BLK(W5054) CYLINDER EXTEND GEN
10	BLK(W5154) CYLINDER RETRACT GEN
11	WHT(W6230) GROUND
12	N/C

AP39345 (BLACK)

PIN	FUNCTION
1	N/C
2	N/C
3	N/C
4	N/C
5	BLK(W5052) CYLINDER EXTEND 3
6	BLK(W5152) CYLINDER RETRACT 3
7	BLK(W5603) AIR SEAL ROOM 3
8	BLK(W5653) VACUUM ROOM 3
9	N/C
10	N/C
11	WHT(W6230) GROUND
12	N/C

AP42210 CN100(GRAY)

PIN	FUNCTION
1	BLK(W5000) GEN SLIDE EXTEND
2	N/C
3	N/C
4	N/C
5	N/C
6	WHT(W6230) GROUND
7	N/C
8	N/C
9	N/C
10	N/C
11	N/C
12	BLK(W5100) GEN SLIDE RETRACT

AP39345 (GRAY)

PIN	FUNCTION
1	RED(W6800) SW BATT
2	RED(W6800) SW BATT
3	GRN(W6230) GROUND
4	GRN(W6230) GROUND

AP42210 CN1(BLACK)

PIN	FUNCTION
1	WHT(W7696) SYSTEM WAKE UP
2	N/C
3	RED(W6800) SW BATT
4	GRN(W6230) GND
5	CAN SHIELD
6	RED(W6110) IGNITION
7	GRN CAN LOW
8	YEL CAN HI

AP42210 CN10(GRAY)

PIN	FUNCTION
1	BLK(W7599) SWITCH LIGHT CONTROL
2	RED(W6100) RESET OUT
3	BLK(W7550) RESET IN
4	RED(W6121) WARN LIGHT SUPPLY
5	WHT(W6230) SWITCH LIGHT SUPPLY
6	BLK(W7699) WARN LIGHT/BUZZER CONTROL

AP42210 CN11(GRAY)

PIN	FUNCTION
1	RED(W6110) IGNITION
2	N/C
3	N/C
4	N/C
5	RED(W6120) IGNITION
6	RED(W6100) HOUSE BATTERY
7	GRN(W6230) GROUND
8	WHT(W9961) NEUTRAL HOLD
9	WHT(W9955) NEUTRAL HOLD
10	N/C
11	WHT(W9000) PARK BRAKE SWITCH
12	RED(W6101) HOUSE BATTERY

AP42210 CN9(GREEN)

PIN	FUNCTION
1	BLK(W8500) MASTER RELAY CNTRL
2	BLK(W8100) SYSTEM PSW.
3	N/C
4	BLK(W8600) PMP RELAY CNTRL
5	BLK(W9900) SPEED SWITCH
6	BLK(W9901) SW BATT FROM PUMP RELAY
7	N/C
8	N/C

AP49030  
REAR ACTIVE AIR INPUT/OUTPUT MODULE

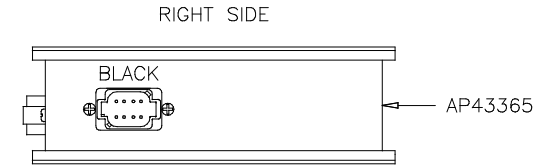
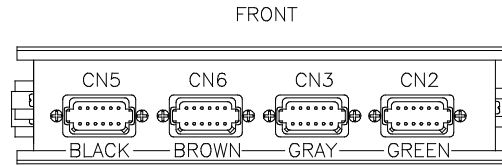
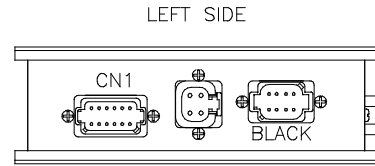

AP43365 CN1 BROWN  
PIN

1	BLK(W4500)	LR RAISE
2	BLK(W4600)	LR LOWER
3	BLK(W4550)	LR HIGH VELOCITY RAISE
4	BLK(W4601)	LR TAG LOWER
5	BLK(W3500)	RR RAISE
6	BLK(W3600)	RR LOWER
7	BLK(W3550)	RR HIGH VELOCITY RAISE
8	BLK(W3601)	RR TAG LOWER
9	BLK(W4501)	LR TAG RAISE
10	BLK(W3501)	RR TAG RAISE
11	WHT(W6258)	GROUND
12	BLK(W3800)	TAG LIFT

AP43365 (GRAY)  
PIN

1	RED (W6800)	SW BATT
2	RED (W6800)	SW BATT
3	GRN (W6230)	GND
4	GRN (W6230)	GND

AP43365 BLACK (LEFT SIDE)  
PIN

1	WHT(W7696)	SYSTEM WAKE UP
2	N/C	
3	RED(W6800)	SW BATTERY
4	GRN(W6230)	GROUND
5	CAN SHIELD	
6	RED(W6110)	IGNITION
7	GRN CAN LOW	
8	YEL CAN HI	

AP43365 BLACK (RIGHT SIDE)  
PIN

1	N/C	
2	N/C	
3	N/C	
4	N/C	
5	N/C	
6	N/C	
7	BLACK 120 ?	RESISTOR
8	BLACK 120 ?	RESISTOR

AP43365 CN5(BLACK)  
PIN

1	BLK(W3100)	RR RIDE HEIGHT LOW
2	BLK(W3101)	RR RIDE HEIGHT MEDIUM
3	BLK(W3102)	RR RIDE HEIGHT HIGH
4	BLK(W3103)	RR ENCODE A
5	BLK(W3104)	RR ENCODE B
6	BLK(W6805)	ROOM SELECT
7	N/C	
8	N/C	
9	N/C	
10	BLK(W5702)	ROOM 3 ROOM IN
11	BLK(W5700)	ROOM 3 ROOM OUT
12	BLK(W5652)	ROOM 3 VACUUM SENSOR

AP43365 CN6(BROWN)  
PIN

1	RED(W6121)	SW. BATT.
2	BLK(W6908)	+5V OUTPUT
3	BLK(W6909)	+5V OUTPUT
4	N/C	
5	N/C	
6	WHT(W6232)	GROUND
7	RED(W6805)	SW BATTERY
8	N/C	
9	N/C	
10	BLK(W3225)	SYSTEM TRANSDUCER
11	BLK(W3221)	RR TAG TRANSDUCER
12	BLK(W3220)	RR TRANSDUCER

AP43365 CN3(GRAY)  
PIN

1	BLK(W4100)	LR RIDE HEIGHT LOW
2	BLK(W4101)	LR RIDE HEIGHT MEDIUM
3	BLK(W4102)	LR RIDE HEIGHT HIGH
4	BLK(W4103)	LR ENCODE A
5	BLK(W4104)	LR ENCODE B
6	BLK(W7501)	EXTEND (ROOM 3)
7	BLK(W7502)	RETRACT (ROOM 3)
8	N/C	
9	N/C	
10	N/C	
11	N/C	
12	N/C	

AP43365 CN2(GREEN)  
PIN

1	RED(W6120)	SW. BATT
2	BLK(W6912)	+5V OUTPUT
3	BLK(W6913)	+5V OUTPUT
4	BLK(W7510)	READY TO OPERATE
5	BLK(W7530)	PUMP
6	WHT(W6233)	GROUND
7	BLK(W6800)	SW. +12V
8	WHT(W7696)	SYSTEM WAKE UP
9	N/C	
10	N/C	
11	BLK(W4221)	LR TAG TRANSDUCER
12	BLK(W4220)	LR TRANSDUCER

NOTE: INSTALLATION MUST CONFORM TO GOOD SHOP PRACTICES, SAE STANDARDS, RVIA STANDARDS, AND OTHER APPLICABLE STANDARDS.

MP90804 C  
18JUL12

AP42581  
FRONT ACTIVE AIR  
MODULE  
RIGHT SIDE

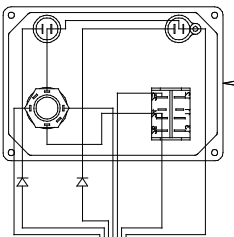
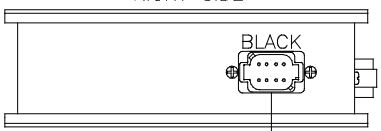

AP22475

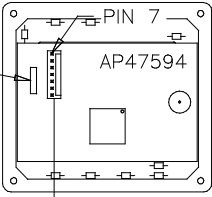

3 AMP  
FUSE

7 1

- 7 PIN
1. WHT(W6100) RESET OUT
  2. WHT(W7550) RESET IN
  3. YELLOW CAN HIGH
  4. GREEN CAN LOW
  5. CAN SHIELD
  6. GRN(W6230) GROUND
  7. BLK(W6800) SW. BATTERY

120 OHM  
TERMINATION  
RESISTOR  
PART OF OEM  
PROVIDED TRUNK  
HARNESS

OEM PROVIDED

OEM PROVIDED

AP42905

- PIN
- |   |                             |
|---|-----------------------------|
| 1 | N/C                         |
| 2 | BLK(W7510) READY TO OPERATE |
| 3 | BLK(W7530) PUMP             |
| 4 | WHT(W7501) EXTEND           |
| 5 | WHT(W7502) RETRACT          |
| 6 | BLK(W6805) SW BATTERY       |
| 7 | BLK(W7631) SYS WAKE UP      |
| 8 | WHT(W6230) GROUND           |

NOTE: INSTALLATION MUST CONFORM TO GOOD SHOP PRACTICES, SAE STANDARDS, RVIA STANDARDS, AND OTHER APPLICABLE STANDARDS.

AP42581  
FRONT ACTIVE AIR MODULE  
FRONT SIDE

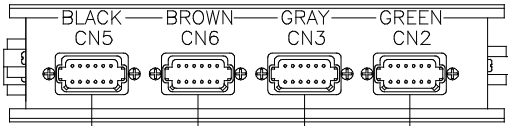

AP42905

BLK(W1220)  
BLK(W6900)  
BLK(W2220)

WHT(W6235)  
BLK(W6901)

- PIN
1. BLK(W7400) STEERING A
  2. BLK(W7401) STEERING B
  3. RED(W6121) SW. BATT
  4. RED(W6120) SW BATT
  5. WHT(W6235) GROUND
  6. WHT(W6235) GROUND
  7. N/C
  8. N/C

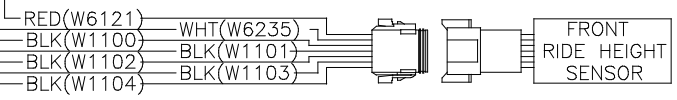
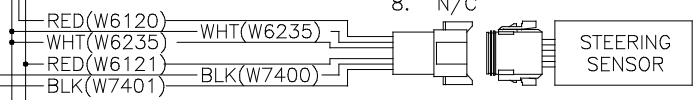

- PIN
1. WHT(W6235) GROUND
  2. BLK(W1101) RIDE HEIGHT MED
  3. BLK(W1102) RIDE HEIGHT HIGH
  4. RED(W6121) SW. BATT
  5. BLK(W1100) RIDE HEIGHT LOW
  6. BLK(W1103) ENCODE A
  7. BLK(W1104) ENCODE B
  8. N/C

VACUUM PRESSURE SENSE ROOM 1

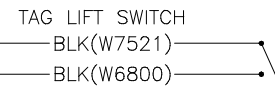
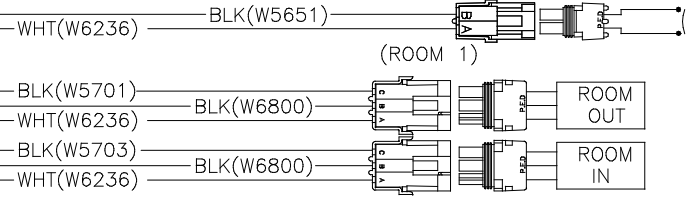

OEM PROVIDED

NOTE: INSTALLATION MUST CONFORM TO GOOD SHOP PRACTICES, SAE STANDARDS, RVIA STANDARDS, AND OTHER APPLICABLE STANDARDS.

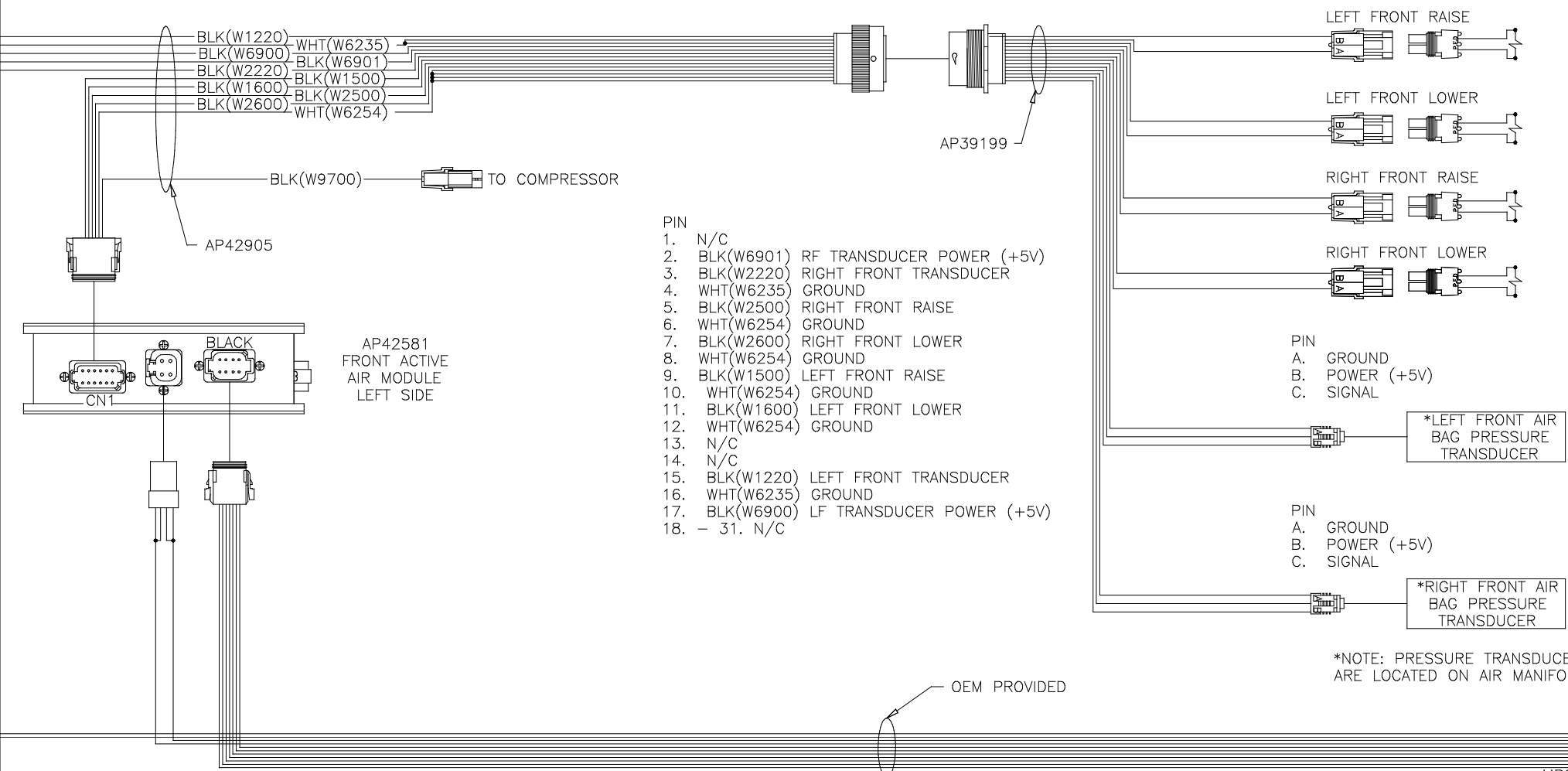

NOTE: INSTALLATION MUST CONFORM TO GOOD SHOP PRACTICES, SAE STANDARDS, RVIA STANDARDS, AND OTHER APPLICABLE STANDARDS.

\*NOTE: PRESSURE TRANSDUCERS ARE LOCATED ON AIR MANIFOLD.

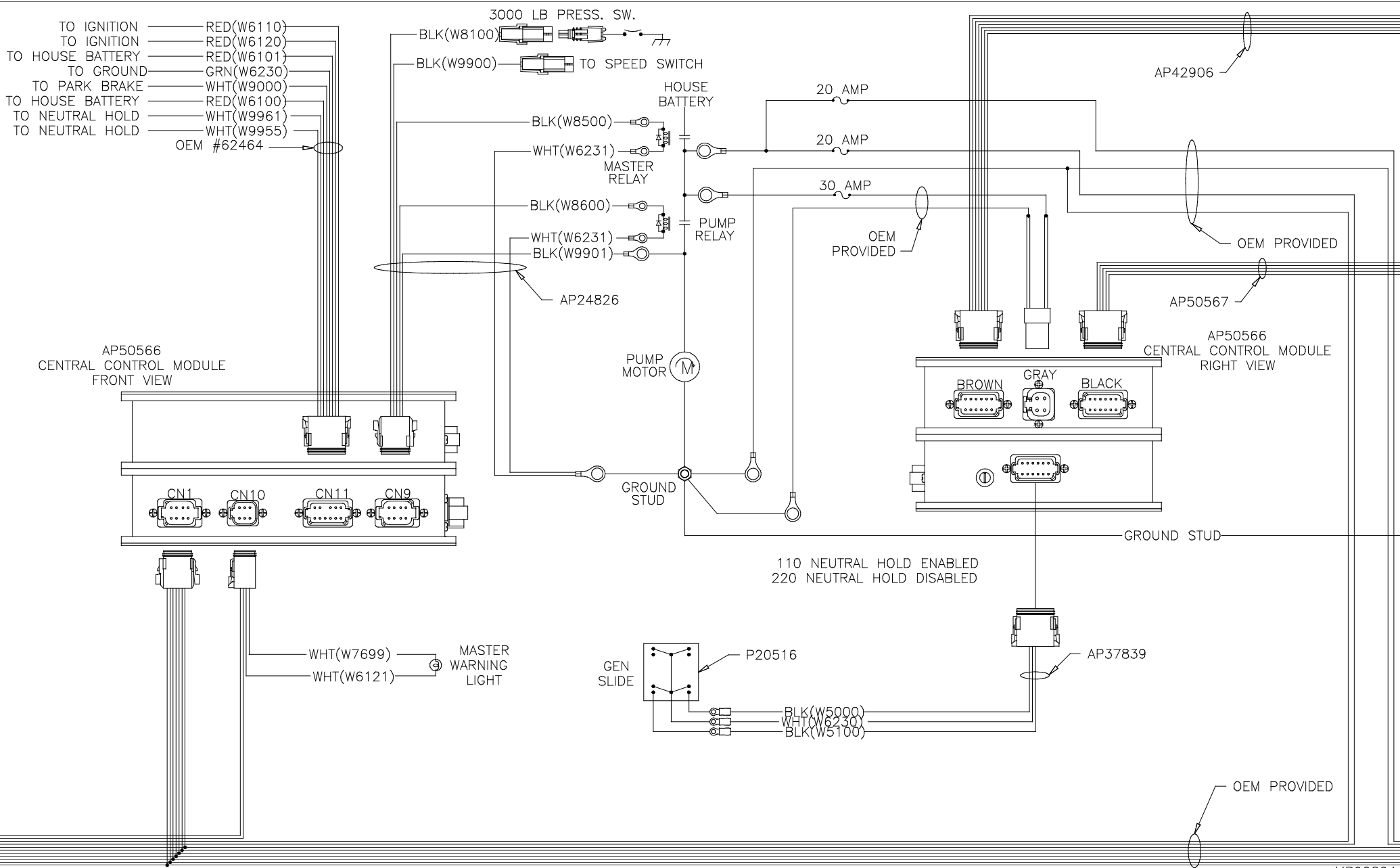

NOTE: INSTALLATION MUST CONFORM TO GOOD SHOP PRACTICES, SAE STANDARDS, RVIA STANDARDS, AND OTHER APPLICABLE STANDARDS.

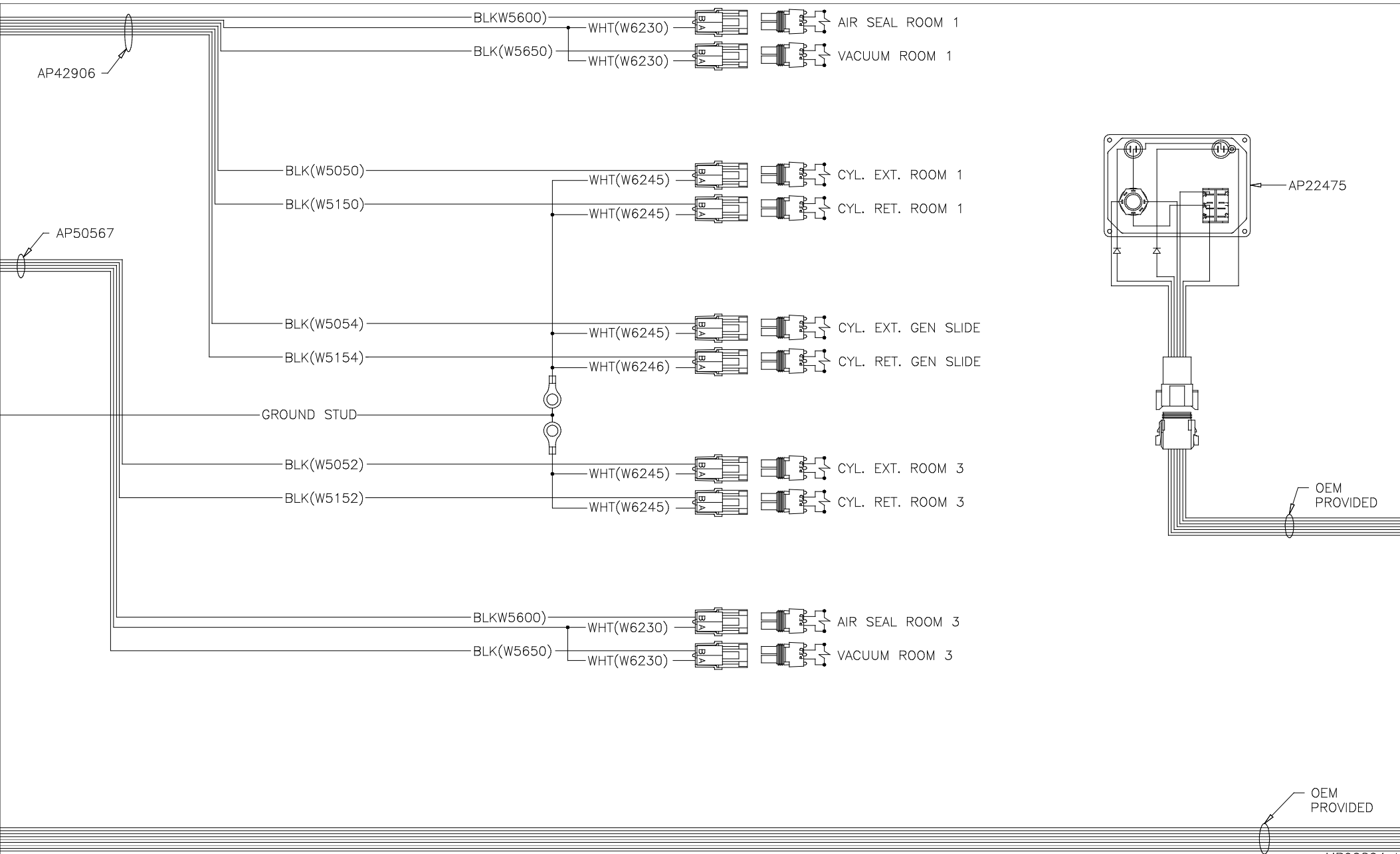

NOTE: INSTALLATION MUST CONFORM TO GOOD SHOP PRACTICES, SAE STANDARDS, RVIA STANDARDS, AND OTHER APPLICABLE STANDARDS.

MP90804 H  
18JUL12



AP49030  
REAR ACTIVE AIR MODULE  
FRONT SIDE

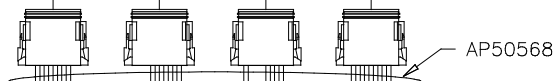
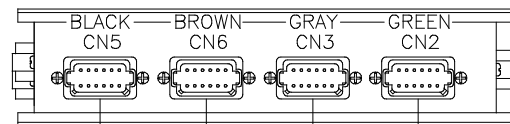

- BLK(W6913) — BLK(W3221)
- BLK(W4220) — BLK(W4221)
- BLK(W6912) — WHT(W6233)
- BLK(W3225) — BLK(W6909)
- WHT(W6232) — BLK(W6908)
- BLK(W3220)

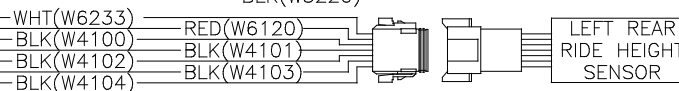

- PIN
- |                                   |                                 |
|-----------------------------------|---------------------------------|
| 1. WHT(W6233) GROUND              | 5. BLK(4100) LR RIDE HEIGHT LOW |
| 2. BLK(W4101) LR RIDE HEIGHT MED  | 6. BLK(4103) LR ENCODE A        |
| 3. BLK(W4102) LR RIDE HEIGHT HIGH | 7. BLK(4104) LR ENCODE B        |
| 4. RED(W6120) SW. BATT            | 8. N/C                          |

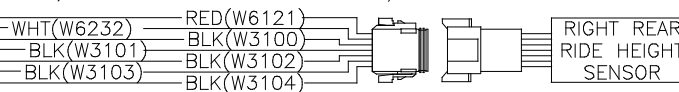

- PIN
- |                                  |                                  |
|----------------------------------|----------------------------------|
| 1. WHT(W6232) GROUND             | 5. RED(W3100) RR RIDE HEIGHT LOW |
| 2. BLK(W3101) RR RIDE HEIGHT MED | 6. BLK(W3103) RR ENCODE A        |
| 3. BLK(W3102) RR RIDE HEIGHT HI  | 7. BLK(W3104) RR ENCODE B        |
| 4. RED(W6121) SW. BATT           | 8. N/C                           |

- OEM PROVIDED
- PIN
- |                               |
|-------------------------------|
| 1 N/C                         |
| 2 BLK(W7510) READY TO OPERATE |
| 3 BLK(W7530) PUMP             |
| 4 WHT(W7501) EXTEND           |
| 5 WHT(W7502) RETRACT          |
| 6 BLK(W6805) SW BATTERY       |
| 7 BLK(W7631) SYS WAKE UP      |
| 8 WHT(W6230) GROUND           |

OEM PROVIDED

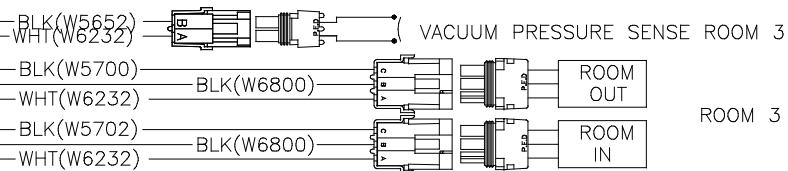

NOTE: INSTALLATION MUST CONFORM TO GOOD SHOP PRACTICES, SAE STANDARDS, RVIA STANDARDS, AND OTHER APPLICABLE STANDARDS.

MP90804-1  
18JUL12

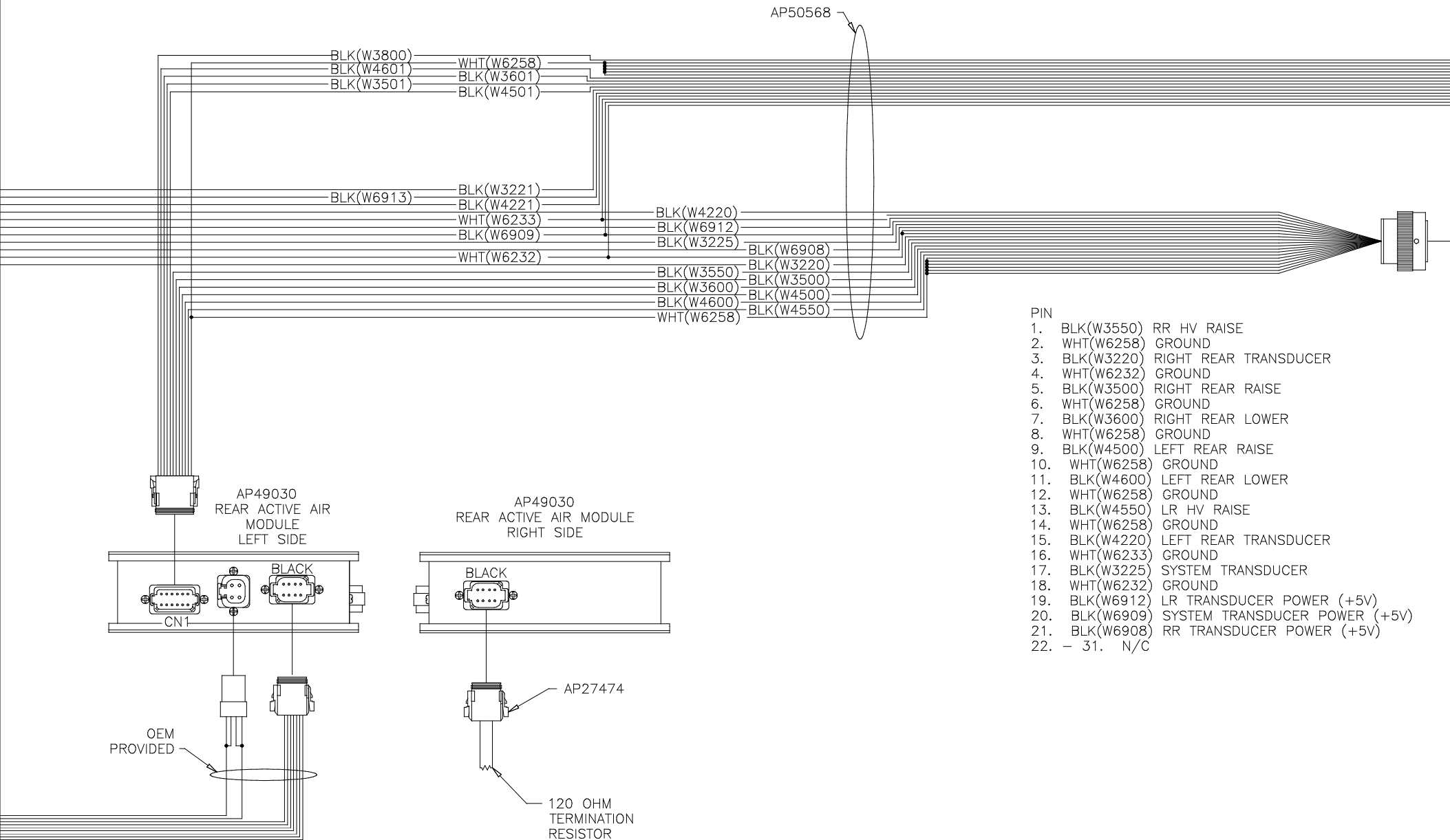

PIN	Wire	Function
1.	BLK(W3550)	RR HV RAISE
2.	WHT(W6258)	GROUND
3.	BLK(W3220)	RIGHT REAR TRANSDUCER
4.	WHT(W6232)	GROUND
5.	BLK(W3500)	RIGHT REAR RAISE
6.	WHT(W6258)	GROUND
7.	BLK(W3600)	RIGHT REAR LOWER
8.	WHT(W6258)	GROUND
9.	BLK(W4500)	LEFT REAR RAISE
10.	WHT(W6258)	GROUND
11.	BLK(W4600)	LEFT REAR LOWER
12.	WHT(W6258)	GROUND
13.	BLK(W4550)	LR HV RAISE
14.	WHT(W6258)	GROUND
15.	BLK(W4220)	LEFT REAR TRANSDUCER
16.	WHT(W6233)	GROUND
17.	BLK(W3225)	SYSTEM TRANSDUCER
18.	WHT(W6232)	GROUND
19.	BLK(W6912)	LR TRANSDUCER POWER (+5V)
20.	BLK(W6909)	SYSTEM TRANSDUCER POWER (+5V)
21.	BLK(W6908)	RR TRANSDUCER POWER (+5V)
22.	- 31.	N/C

NOTE: INSTALLATION MUST CONFORM TO GOOD SHOP PRACTICES, SAE STANDARDS, RVIA STANDARDS, AND OTHER APPLICABLE STANDARDS.

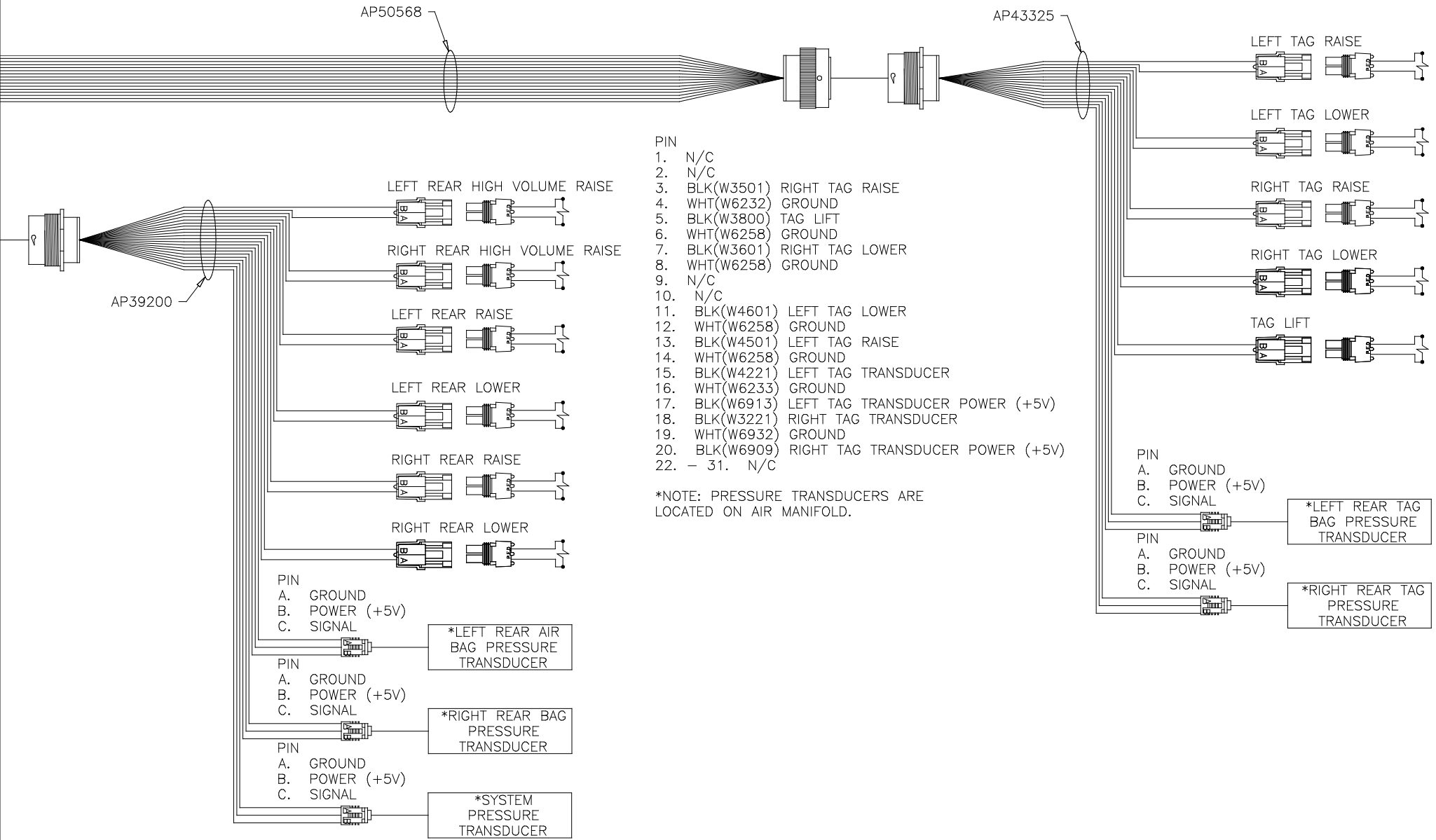

AP50568

AP43325

AP39200

- LEFT REAR HIGH VOLUME RAISE
- RIGHT REAR HIGH VOLUME RAISE
- LEFT REAR RAISE
- LEFT REAR LOWER
- RIGHT REAR RAISE
- RIGHT REAR LOWER

- PIN
1. N/C
  2. N/C
  3. BLK(W3501) RIGHT TAG RAISE
  4. WHT(W6232) GROUND
  5. BLK(W3800) TAG LIFT
  6. WHT(W6258) GROUND
  7. BLK(W3601) RIGHT TAG LOWER
  8. WHT(W6258) GROUND
  9. N/C
  10. N/C
  11. BLK(W4601) LEFT TAG LOWER
  12. WHT(W6258) GROUND
  13. BLK(W4501) LEFT TAG RAISE
  14. WHT(W6258) GROUND
  15. BLK(W4221) LEFT TAG TRANSDUCER
  16. WHT(W6233) GROUND
  17. BLK(W6913) LEFT TAG TRANSDUCER POWER (+5V)
  18. BLK(W3221) RIGHT TAG TRANSDUCER
  19. WHT(W6932) GROUND
  20. BLK(W6909) RIGHT TAG TRANSDUCER POWER (+5V)
  22. - 31. N/C

- LEFT TAG RAISE
- LEFT TAG LOWER
- RIGHT TAG RAISE
- RIGHT TAG LOWER
- TAG LIFT

- PIN
- A. GROUND
  - B. POWER (+5V)
  - C. SIGNAL
- \*LEFT REAR AIR BAG PRESSURE TRANSDUCER
- PIN
- A. GROUND
  - B. POWER (+5V)
  - C. SIGNAL
- \*RIGHT REAR BAG PRESSURE TRANSDUCER
- PIN
- A. GROUND
  - B. POWER (+5V)
  - C. SIGNAL
- \*SYSTEM PRESSURE TRANSDUCER

- PIN
- A. GROUND
  - B. POWER (+5V)
  - C. SIGNAL
- \*LEFT REAR TAG BAG PRESSURE TRANSDUCER
- PIN
- A. GROUND
  - B. POWER (+5V)
  - C. SIGNAL
- \*RIGHT REAR TAG PRESSURE TRANSDUCER

\*NOTE: PRESSURE TRANSDUCERS ARE LOCATED ON AIR MANIFOLD.

NOTE: INSTALLATION MUST CONFORM TO GOOD SHOP PRACTICES, SAE STANDARDS, RVIA STANDARDS, AND OTHER APPLICABLE STANDARDS.

MP90804 K  
18JUL12

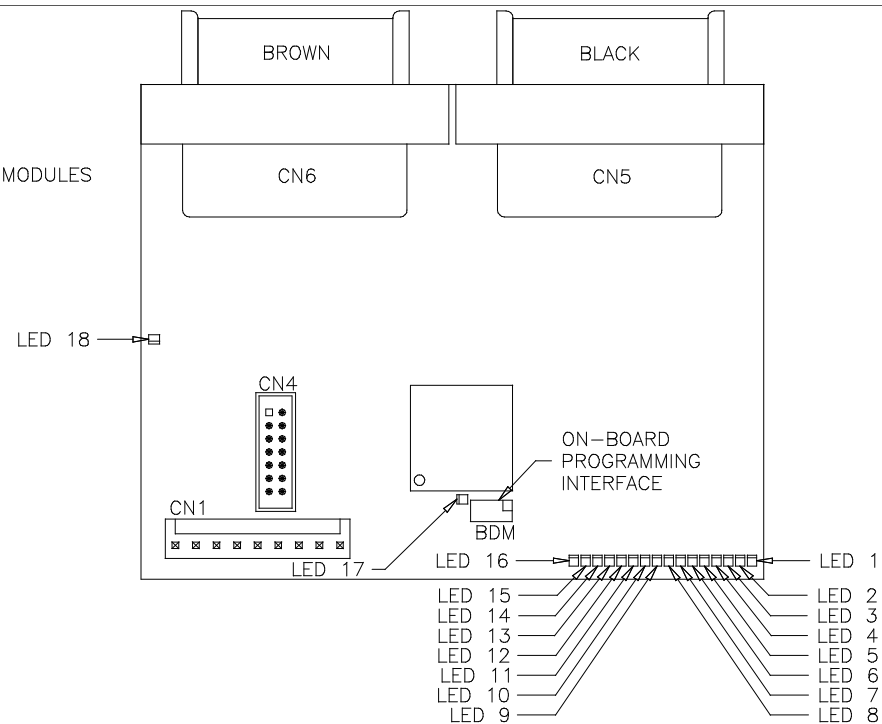
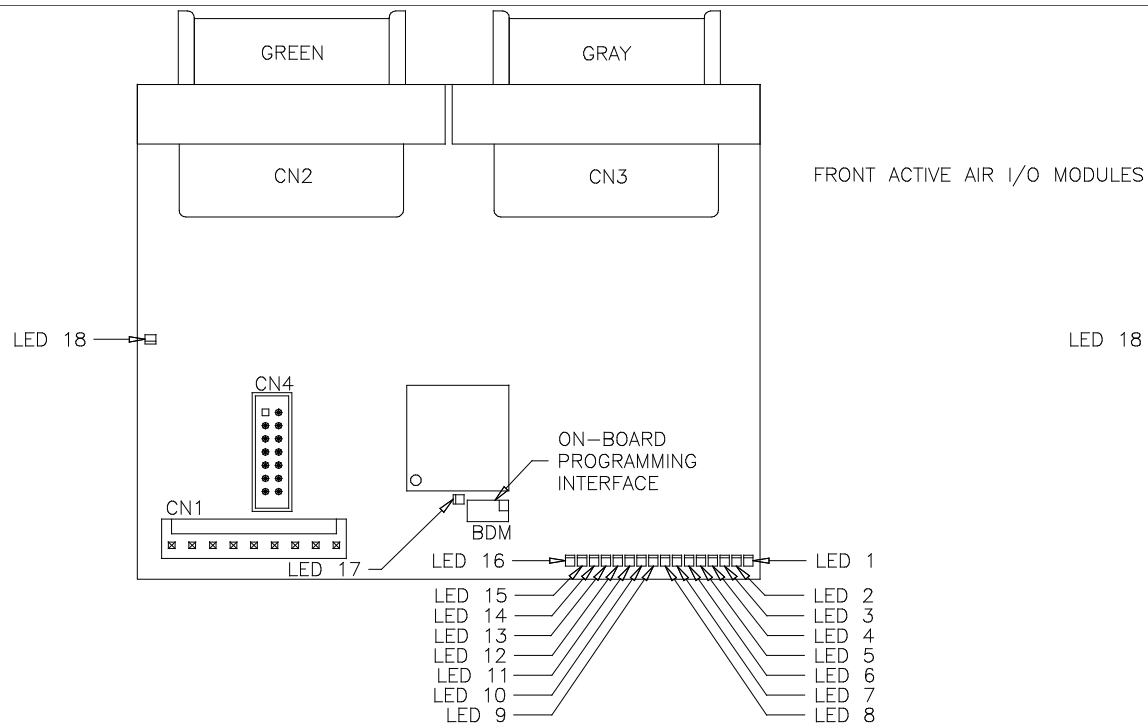

LED #	CONNECTOR	COLOR	DESCRIPTION
LED 1	CN3 PIN 1	RED	FRONT RIDE HEIGHT LOW
LED 2	CN3 PIN 2	GREEN	FRONT RIDE HEIGHT MED
LED 3	CN3 PIN 3	YELLOW	FRONT RIDE HEIGHT HIGH
LED 4	CN3 PIN 4	RED	ENCODE A
LED 5	CN3 PIN 5	GREEN	ENCODE B
LED 6	NOT USED	YELLOW	NOT USED
LED 7	NOT USED	RED	NOT USED
LED 8	CN3 PIN 8	GREEN	STEERING A
LED 9	CN3 PIN 9	YELLOW	STEERING B
LED 10	CN3 PIN 10	RED	TAG LIFT
LED 11	NOT USED	GREEN	NOT USED
LED 12	NOT USED	YELLOW	NOT USED
LED 13	NOT USED	RED	NOT USED
LED 14	NOT USED	GREEN	NOT USED
LED 15	NOT USED	YELLOW	NOT USED
LED 16	NOT USED	RED	NOT USED
LED 17	NOT APPLICABLE	RED	LINK LIGHT
LED 18	NOT APPLICABLE	RED	POWER TO CAN MODULES

LED #	CONNECTOR	COLOR	DESCRIPTION
LED 1	CN5 PIN 1	RED	ROOM 1 ROOM IN
LED 2	CN5 PIN 2	GREEN	ROOM 1 ROOM OUT
LED 3	CN5 PIN 3	YELLOW	ROOM 1 VACUUM SENSOR
LED 4	NOT USED	RED	NOT USED
LED 5	NOT USED	GREEN	NOT USED
LED 6	CN5 PIN 6	YELLOW	EXTEND (ROOM 1)
LED 7	CN5 PIN 7	RED	RETRACT (ROOM 1)
LED 8	NOT USED	GREEN	NOT USED
LED 9	NOT USED	YELLOW	NOT USED
LED 10	NOT USED	RED	NOT USED
LED 11	NOT USED	GREEN	NOT USED
LED 12	NOT USED	YELLOW	NOT USED
LED 13	NOT USED	RED	NOT USED
LED 14	NOT USED	GREEN	NOT USED
LED 15	NOT USED	YELLOW	NOT USED
LED 16	CN6 PIN 8	RED	SYSTEM WAKE UP
LED 17	NOT APPLICABLE	RED	LINK LIGHT
LED 18	NOT APPLICABLE	RED	POWER TO CAN MODULES

NOTE: INSTALLATION MUST CONFORM TO GOOD SHOP PRACTICES, SAE STANDARDS, RVIA STANDARDS, AND OTHER APPLICABLE STANDARDS.

MP90804 L  
18JUL12

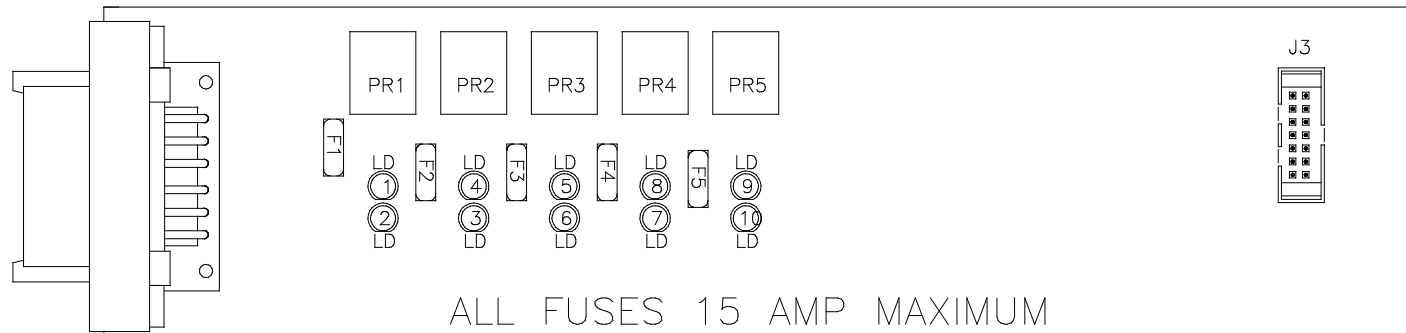

FRONT AIR  
LED LAYOUT

LED #	COLOR	FUSE #	OUTPUT	RELAY #	DESCRIPTION
LED1	YELLOW	---	---	PR1	LEFT FRONT RAISE (COIL)
LED2	RED	FUSE 1	PIN 1	PR1	LEFT FRONT RAISE (CONTACT)
LED3	RED	FUSE 2	PIN 2	PR2	LEFT FRONT LOWER (CONTACT)
LED4	YELLOW	---	---	PR2	LEFT FRONT LOWER (COIL)
LED5	YELLOW	---	---	PR3	RIGHT FRONT RAISE (COIL)
LED6	RED	FUSE 3	PIN 3	PR3	RIGHT FRONT RAISE (CONTACT)
LED7	RED	FUSE 4	PIN 4	PR4	RIGHT FRONT LOWER (CONTACT)
LED8	YELLOW	---	---	PR4	RIGHT FRONT LOWER (COIL)
LED9	YELLOW	---	---	PR5	COMPRESSOR (COIL)
LED10	RED	FUSE 5	PIN 5	PR5	COMPRESSOR (CONTACT)

GENERATOR SLIDE/STEP COVER  
REED SWITCH  
LAYOUT

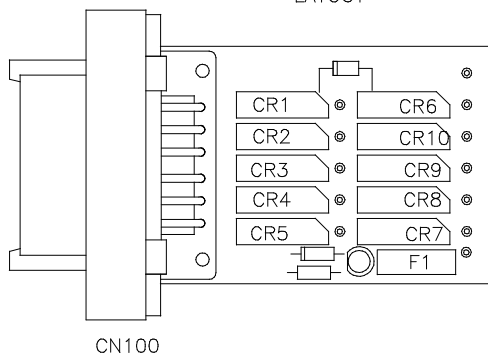

CN100

CONNECTOR	REED SWITCH	DESCRIPTION
CN 100 PIN 1	CR1	GEN SLIDE EXTEND
CN 100 PIN 2	CR2	NOT USED
CN 100 PIN 3	CR3	NOT USED
CN 100 PIN 4	CR4	NOT USED
CN 100 PIN 5	CR5	NOT USED
CN 100 PIN 6	---	GROUND
CN 100 PIN 7	---	NOT USED
CN 100 PIN 8	CR7	NOT USED
CN 100 PIN 9	CR8	NOT USED
CN 100 PIN 10	CR9	NOT USED
CN 100 PIN 11	CR10	NOT USED
CN 100 PIN 12	CR6	GEN SLIDE RETRACT

NOTE: INSTALLATION MUST CONFORM TO GOOD SHOP PRACTICES, SAE STANDARDS, RVIA STANDARDS, AND OTHER APPLICABLE STANDARDS.

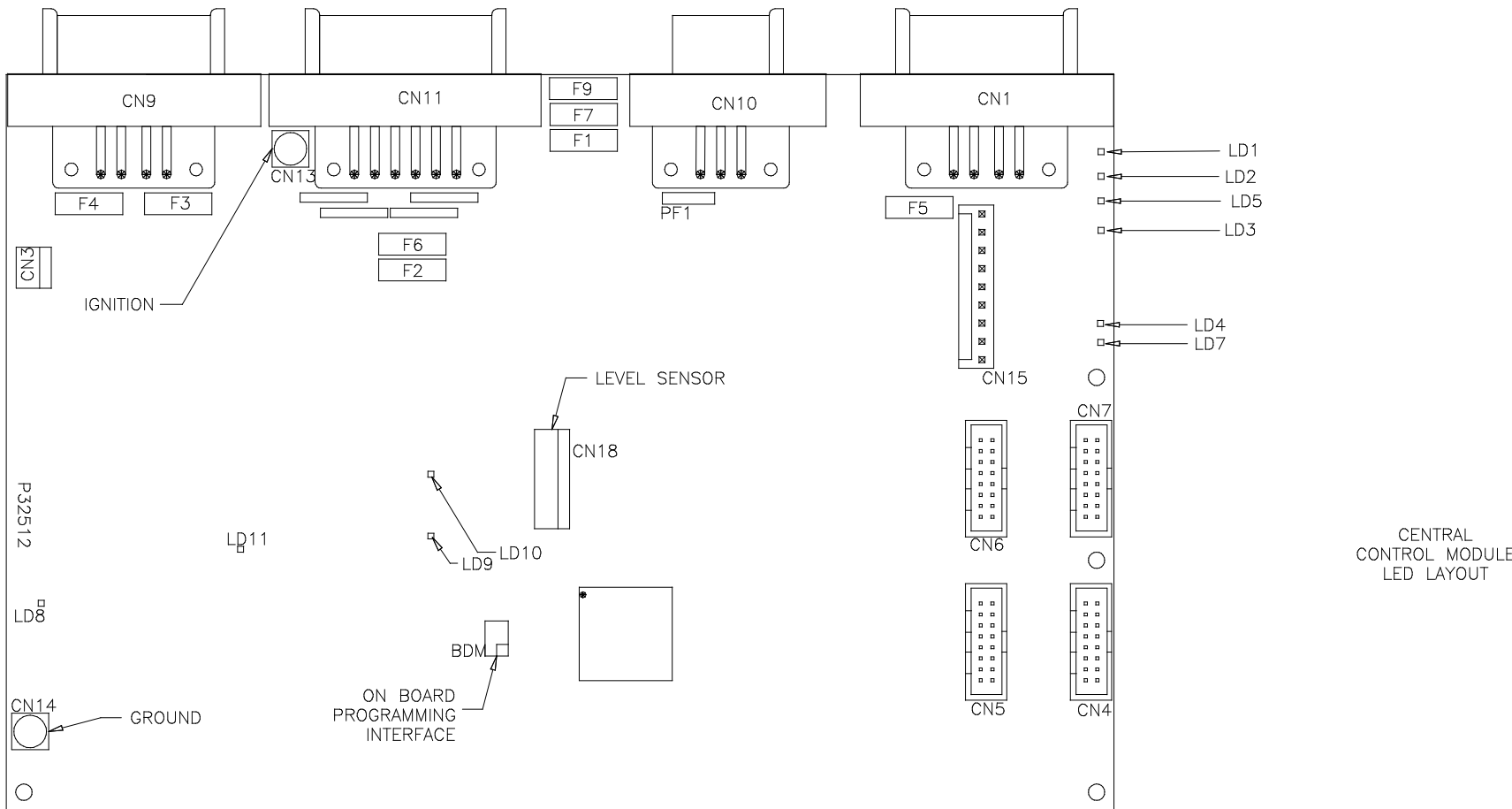

LED #	CONNECTOR	COLOR	DESCRIPTION
LED 1	CN 9 PIN 1	RED	MASTER RELAY
LED 2	CN 9 PIN 4	RED	PUMP RELAY
LED 3	CN 1 PIN 3	RED	SW 12V
LED 4	CN 11 PIN 12	RED	ENGINE BATT
LED 5	CN 9 PIN 5	RED	SPEED SWITCH
LED 7	CN 1 PIN 7 & 8	RED	LINK LIGHT
LED 8	CN 11 PIN 8 & 9	RED	NEUTRAL HOLD
LED 9	NOT USED	NOT USED	NOT USED
LED 10	CN9 PIN 2	RED	3000 LBS. PSW
LED 11	CN11 PIN 11	RED	PARK BRAKE

FUSE #	DESCRIPTION
PF1	RESET OUT
F7	ACCESSORY
F1	IGNITION
F2	HOUSE BATTERY
F3	MASTER RELAY
F4	PUMP RELAY
F5	SW. BATT TO CAN MODULES
F6	ENGINE BATTERY
F9	POWER TO CN100

NOTE: INSTALLATION MUST CONFORM TO GOOD SHOP PRACTICES, SAE STANDARDS, RVIA STANDARDS, AND OTHER APPLICABLE STANDARDS.

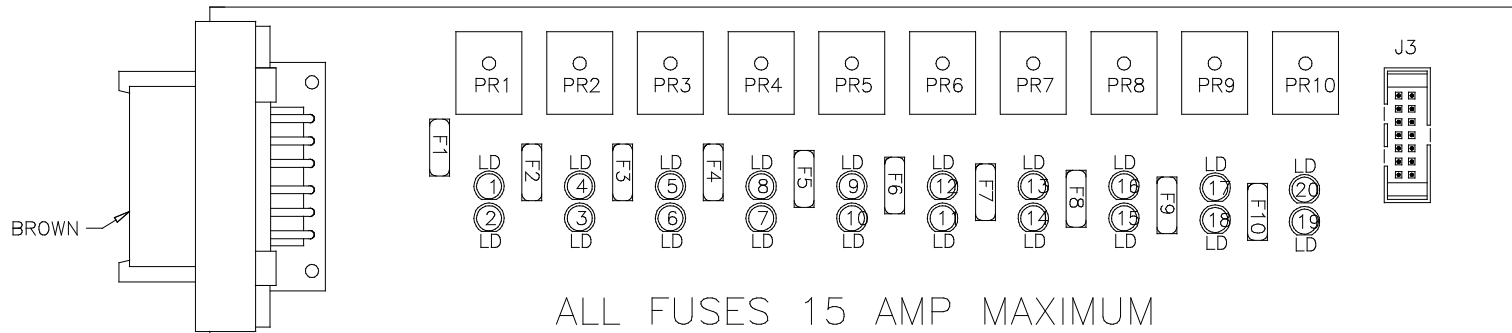

ROOM OUTPUTS  
LED LAYOUT

LED #	COLOR	FUSE #	OUTPUT	RELAY #	DESCRIPTION
LED1	YELLOW	---	---	PR1	CYLINDER EXTEND 1 (COIL)
LED2	RED	FUSE 1	PIN 1	PR1	CYLINDER EXTEND 1 (CONTACT)
LED3	RED	FUSE 2	PIN 2	PR2	CYLINDER RETRACT 1 (CONTACT)
LED4	YELLOW	---	---	PR2	CYLINDER RETRACT 1 (COIL)
LED5	YELLOW	---	---	PR3	AIR SEAL ROOM 1 (COIL)
LED6	RED	FUSE 3	PIN 3	PR3	AIR SEAL ROOM 1 (CONTACT)
LED7	RED	FUSE 4	PIN 4	PR4	VACUUM ROOM 1 (CONTACT)
LED8	YELLOW	---	---	PR4	VACUUM ROOM 1 (COIL)
LED9	YELLOW	---	---	PR5	NOT USED
LED10	RED	FUSE 5	PIN 5	PR5	NOT USED
LED11	RED	FUSE 6	PIN 6	PR6	NOT USED
LED12	YELLOW	---	---	PR6	NOT USED
LED13	YELLOW	---	---	PR7	NOT USED
LED14	RED	FUSE 7	PIN 7	PR7	NOT USED
LED15	RED	FUSE 8	PIN 8	PR8	NOT USED
LED16	YELLOW	---	---	PR8	NOT USED
LED17	YELLOW	---	---	PR9	CYLINDER EXTEND GEN (COIL)
LED18	RED	FUSE 9	PIN 9	PR9	CYLINDER EXTEND GEN (CONTACT)
LED19	RED	FUSE 10	PIN 10	PR10	CYLINDER RETRACT GEN (CONTACT)
LED20	YELLOW	---	---	PR10	CYLINDER RETRACT GEN (COIL)

NOTE: INSTALLATION MUST CONFORM TO GOOD SHOP PRACTICES, SAE STANDARDS, RVIA STANDARDS, AND OTHER APPLICABLE STANDARDS.

MP90804 0  
18JUL12

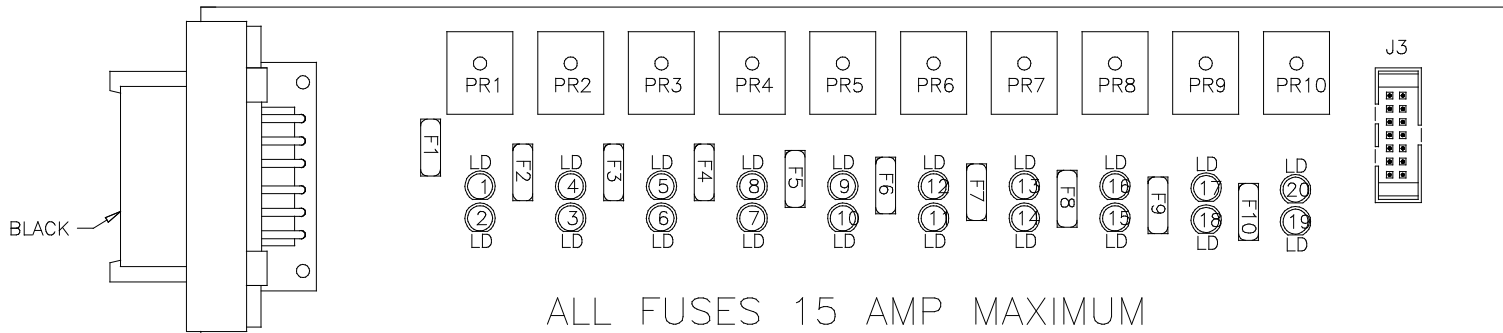

ROOM OUTPUTS  
LED LAYOUT

LED #	COLOR	FUSE #	OUTPUT	RELAY #	DESCRIPTION
LED1	YELLOW	---	---	PR1	NOT USED
LED2	RED	FUSE 1	PIN 1	PR1	NOT USED
LED3	RED	FUSE 2	PIN 2	PR2	NOT USED
LED4	YELLOW	---	---	PR2	NOT USED
LED5	YELLOW	---	---	PR3	NOT USED
LED6	RED	FUSE 3	PIN 3	PR3	NOT USED
LED7	RED	FUSE 4	PIN 4	PR4	NOT USED
LED8	YELLOW	---	---	PR4	NOT USED
LED9	YELLOW	---	---	PR5	CYLINDER EXTEND 3 (COIL)
LED10	RED	FUSE 5	PIN 5	PR5	CYLINDER EXTEND 3 (CONTACT)
LED11	RED	FUSE 6	PIN 6	PR6	CYLINDER RETRACT 3 (CONTACT)
LED12	YELLOW	---	---	PR6	CYLINDER RETRACT 3 (COIL)
LED13	YELLOW	---	---	PR7	AIR SEAL ROOM 3 (COIL)
LED14	RED	FUSE 7	PIN 7	PR7	AIR SEAL ROOM 3 (CONTACT)
LED15	RED	FUSE 8	PIN 8	PR8	VACCUM ROOM 3 (CONTACT)
LED16	YELLOW	---	---	PR8	VACCUM ROOM 3 (COIL)
LED17	YELLOW	---	---	PR9	NOT USED
LED18	RED	FUSE 9	PIN 9	PR9	NOT USED
LED19	RED	FUSE 10	PIN 10	PR10	NOT USED
LED20	YELLOW	---	---	PR10	NOT USED

NOTE: INSTALLATION MUST CONFORM TO GOOD SHOP PRACTICES, SAE STANDARDS, RVIA STANDARDS, AND OTHER APPLICABLE STANDARDS.

MP90804 P  
18JUL12



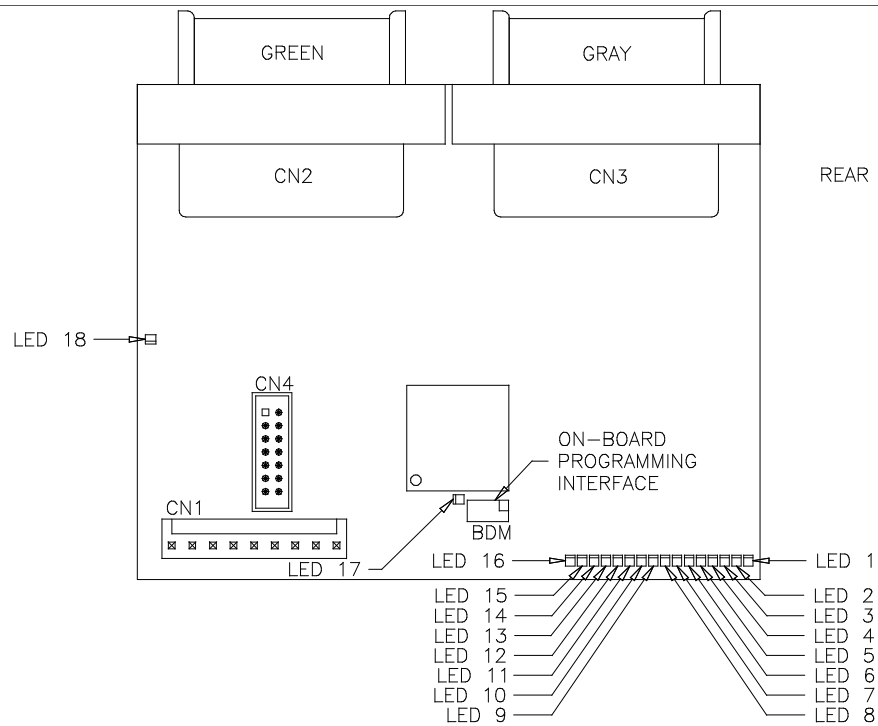

REAR ACTIVE AIR I/O MODULES

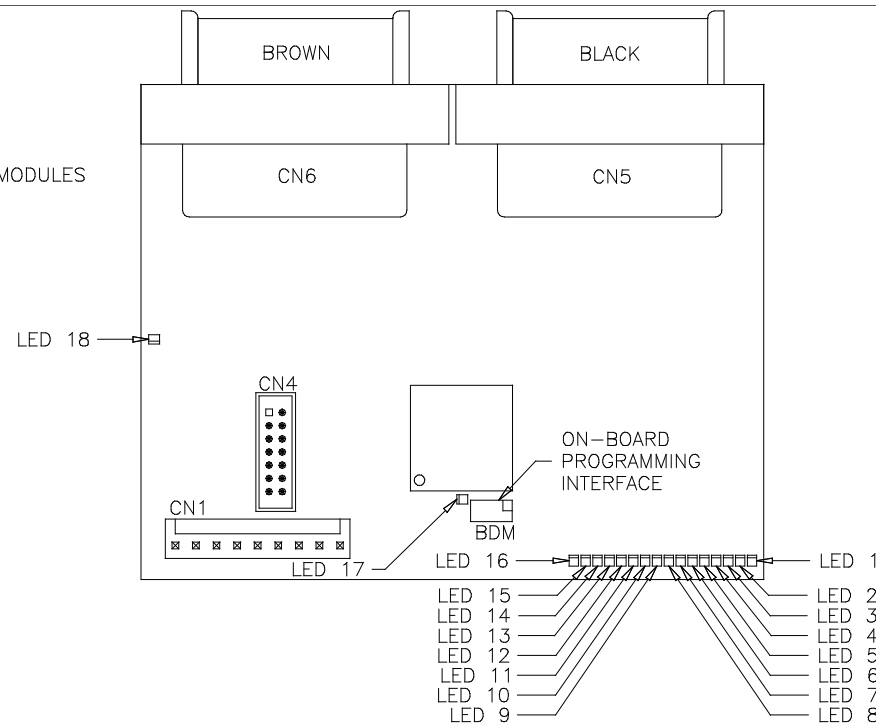

LED #	CONNECTOR	COLOR	DESCRIPTION
LED 1	CN3 PIN 1	RED	LR RIDE HEIGHT LOW
LED 2	CN3 PIN 2	GREEN	LR RIDE HEIGHT MED
LED 3	CN3 PIN 3	YELLOW	LR RIDE HEIGHT HIGH
LED 4	CN3 PIN 4	RED	LR ENCODE A
LED 5	CN3 PIN 5	GREEN	LR ENCODE B
LED 6	CN3 PIN 6	YELLOW	EXTEND (ROOM 3)
LED 7	CN3 PIN 7	RED	RETRACT (ROOM 3)
LED 8	NOT USED	GREEN	NOT USED
LED 9	NOT USED	YELLOW	NOT USED
LED 10	NOT USED	RED	NOT USED
LED 11	NOT USED	GREEN	NOT USED
LED 12	NOT USED	YELLOW	NOT USED
LED 13	NOT USED	RED	NOT USED
LED 14	NOT USED	GREEN	NOT USED
LED 15	NOT USED	YELLOW	NOT USED
LED 16	CN2 PIN 8	RED	SYSTEM WAKE UP
LED 17	NOT APPLICABLE	RED	LINK LIGHT
LED 18	NOT APPLICABLE	RED	POWER TO CAN MODULES

LED #	CONNECTOR	COLOR	DESCRIPTION
LED 1	CN5 PIN 1	RED	RR RIDE HEIGHT LOW
LED 2	CN5 PIN 2	GREEN	RR RIDE HEIGHT MED
LED 3	CN5 PIN 3	YELLOW	RR RIDE HEIGHT HIGH
LED 4	CN5 PIN 4	RED	RR ENCODE A
LED 5	CN5 PIN 5	GREEN	RR ENCODE B
LED 6	CN5 PIN 6	YELLOW	ROOM SELECT
LED 7	NOT USED	RED	NOT USED
LED 8	NOT USED	GREEN	NOT USED
LED 9	NOT USED	YELLOW	NOT USED
LED 10	CN5 PIN 10	RED	ROOM 3 ROOM IN
LED 11	CN5 PIN 11	GREEN	ROOM 3 ROOM OUT
LED 12	CN5 PIN 12	YELLOW	ROOM 3 VACUUM SENSOR
LED 13	NOT USED	RED	NOT USED
LED 14	NOT USED	GREEN	NOT USED
LED 15	NOT USED	YELLOW	NOT USED
LED 16	NOT USED	RED	NOT USED
LED 17	NOT APPLICABLE	RED	LINK LIGHT
LED 18	NOT APPLICABLE	RED	POWER TO CAN MODULES

NOTE: INSTALLATION MUST CONFORM TO GOOD SHOP PRACTICES, SAE STANDARDS, RVIA STANDARDS, AND OTHER APPLICABLE STANDARDS.

MP90804 Q  
18JUL12

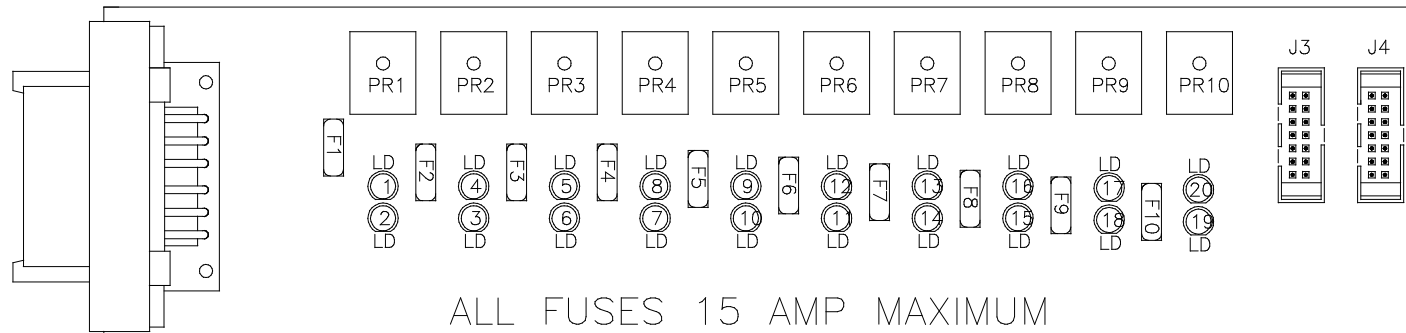

REAR AIR  
LED LAYOUT

LED #	COLOR	FUSE #	OUTPUT	RELAY #	DESCRIPTION
LED1	YELLOW	---	---	PR1	LEFT REAR RAISE (COIL)
LED2	RED	FUSE 1	PIN 1	PR1	LEFT REAR RAISE (CONTACT)
LED3	RED	FUSE 2	PIN 2	PR2	LEFT REAR LOWER (CONTACT)
LED4	YELLOW	---	---	PR2	LEFT REAR LOWER (COIL)
LED5	YELLOW	---	---	PR3	LEFT REAR HIGH VOL RAISE (COIL)
LED6	RED	FUSE 3	PIN 3	PR3	LEFT REAR HIGH VOL RAISE (CONTACT)
LED7	RED	FUSE 4	PIN 4	PR4	LEFT REAR TAG LOWER (CONTACT)
LED8	YELLOW	---	---	PR4	LEFT REAR TAG LOWER (COIL)
LED9	YELLOW	---	---	PR5	RIGHT REAR RAISE (COIL)
LED10	RED	FUSE 5	PIN 5	PR5	RIGHT REAR RAISE (CONTACT)
LED11	RED	FUSE 6	PIN 6	PR6	RIGHT REAR LOWER (CONTACT)
LED12	YELLOW	---	---	PR6	RIGHT REAR LOWER (COIL)
LED13	YELLOW	---	---	PR7	RIGHT REAR HIGH VOL RAISE (COIL)
LED14	RED	FUSE 7	PIN 7	PR7	RIGHT REAR HIGH VOL RAISE (CONTACT)
LED15	RED	FUSE 8	PIN 8	PR8	RIGHT REAR TAG LOWER (CONTACT)
LED16	YELLOW	---	---	PR8	RIGHT REAR TAG LOWER (COIL)
LED17	YELLOW	---	---	PR9	LEFT REAR TAG RAISE (COIL)
LED18	RED	FUSE 9	PIN 9	PR9	LEFT REAR TAG RAISE (CONTACT)
LED19	RED	FUSE 10	PIN 10	PR10	RIGHT REAR TAG RAISE (CONTACT)
LED20	YELLOW	---	---	PR10	RIGHT REAR TAG RAISE (COIL)

NOTE: INSTALLATION MUST CONFORM TO GOOD SHOP PRACTICES, SAE STANDARDS, RVIA STANDARDS, AND OTHER APPLICABLE STANDARDS.

MP90804 R  
18JUL12