

ORIENTATION
 ← FRONT

Ⓐ

Ⓑ

Ⓒ

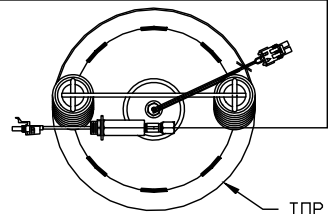

TOP VIEW
 AP53815
 RIGHT FRONT

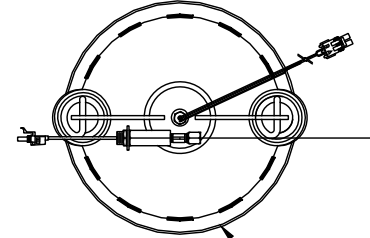

TOP VIEW
 AP53816
 RIGHT REAR

- Ⓐ AP4948 HOSE ASSY .25" x 390"
- Ⓑ AP10566 HOSE ASSY .25" x 102"
- Ⓒ AP4073 HOSE ASSY .25" x 60"
- Ⓓ AP10256 HOSE ASSY .25" x 366"

TOP VIEW-MANIFOLD

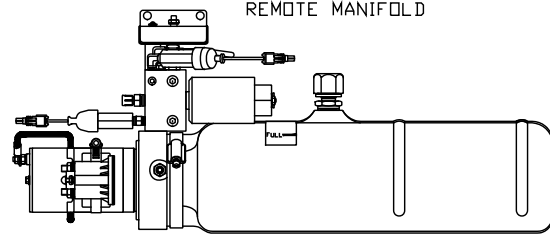
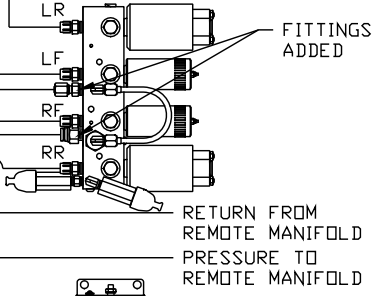

SIDE VIEW PWR/CONTROL-AP46385

LOCATION AND ORIENTATION OF
 PUMP/MANIFOLD ASSEMBLY WILL
 DIFFER DEPENDING UPON O.E.M.

NOTE: INSTALLATION MUST CONFORM TO GOOD SHOP PRACTICES, SAE
 STANDARDS, RVIA STANDARDS, AND OTHER APPLICABLE STANDARDS.

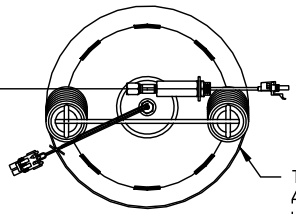

TOP VIEW
 AP53815
 LEFT FRONT

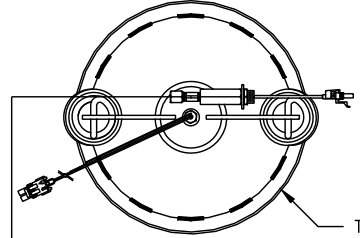

TOP VIEW
 AP53816
 LEFT REAR

NOTE: REFERENCE HH56268 FOR COMPONENT SUMMARY.

NO.	DATE	REVISION

HWH I-80 EXIT 267 SOUTH
 RT 1 MOSCOW, IOWA 52760
 SCALE 1:6 DATE 15JUN16 DRAWN BY .

HYD CONN DIAGRAM

THE INFORMATION DISCLOSED ON THIS DRAWING IS CONFIDENTIAL AND MUST NOT BE DISCLOSED OR USED IN ANY MANNER WHICH WILL BE DETRIMENTAL TO THE HWH CORPORATION

WINNEBAGO

DRAWING NUMBER
 MP71007 A/B

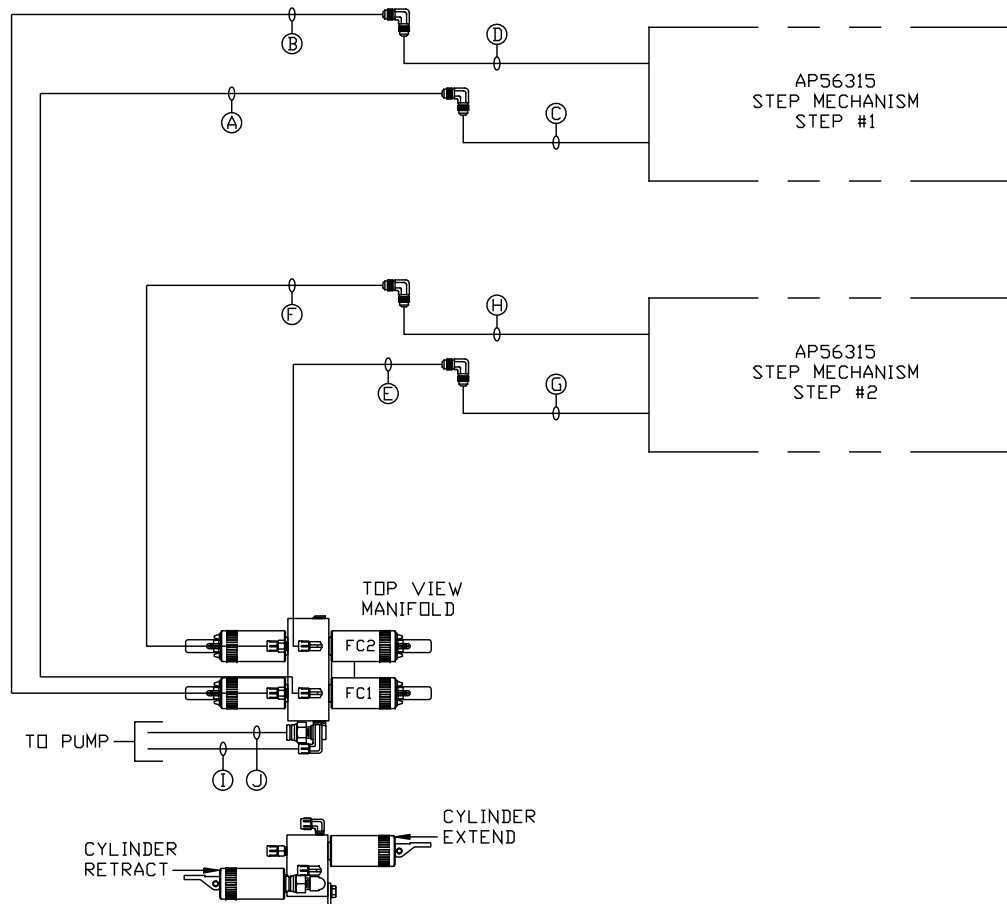

SIDE VIEW OF MANIFOLD-AP50289-02

LOCATION AND ORIENTATION OF
PUMP/MANIFOLD ASSEMBLY WILL
DIFFER DEPENDING UPON O.E.M.

NOTE: HOSES (C), (D), (G), AND (H) ARE
INCLUDED WITH THE STEP MECHANISM.

- (A) HOSE ASSY 04
ROD END - ALWAYS PRESSURIZED
- (B) HOSE ASSY 04
CAP END
- (C) AP50909 HOSE ASSY 03F x 72"
ROD END - ALWAYS PRESSURIZED
- (D) AP51480 HOSE ASSY 03F x 66"
CAP END
- (E) HOSE ASSY 04
ROD END - ALWAYS PRESSURIZED
- (F) HOSE ASSY 04
CAP END
- (G) AP50909 HOSE ASSY 03F x 72"
ROD END - ALWAYS PRESSURIZED
- (H) AP51480 HOSE ASSY 03F x 66"
CAP END
- (I) HOSE ASSY 04
PRESSURE
- (J) TUBING NYLON 3/8"
RETURN

NOTE: INSTALLATION MUST CONFORM TO GOOD SHOP PRACTICES, SAE
STANDARDS, RVIA STANDARDS, AND OTHER APPLICABLE STANDARDS.

MP71007 B/B
15JUN16