

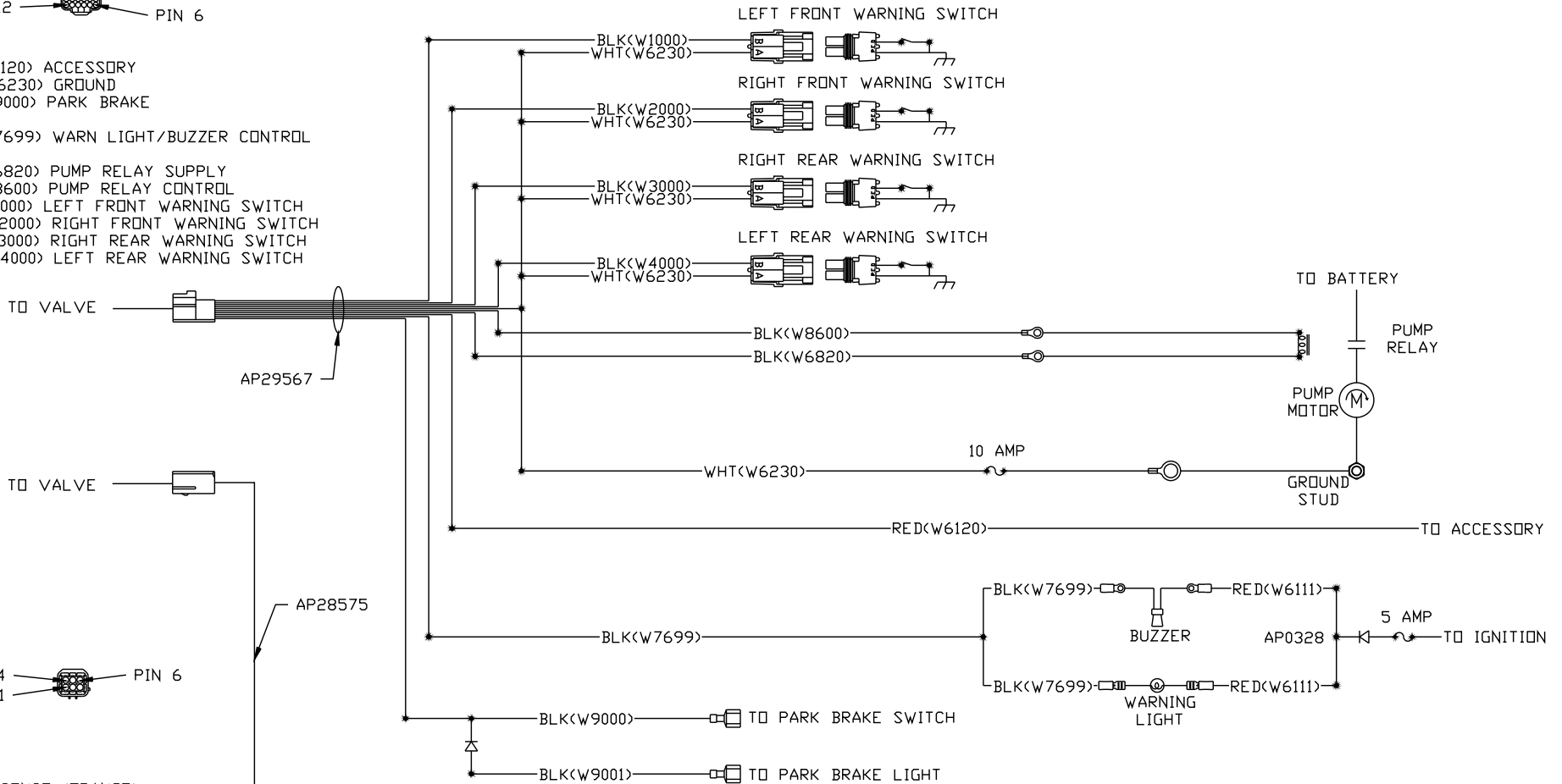

- PIN
1. RED<W6120> ACCESSORY
 2. WHT<W6230> GROUND
 3. BLK<W9000> PARK BRAKE
 4. N/C
 5. BLK<W7699> WARN LIGHT/BUZZER CONTROL
 6. N/C
 7. BLK<W6820> PUMP RELAY SUPPLY
 8. BLK<W8600> PUMP RELAY CONTROL
 9. BLK<W1000> LEFT FRONT WARNING SWITCH
 10. BLK<W2000> RIGHT FRONT WARNING SWITCH
 11. BLK<W3000> RIGHT REAR WARNING SWITCH
 12. BLK<W4000> LEFT REAR WARNING SWITCH



- PIN
1. FRONT SENSE (ORANGE)
 2. GROUND (WHITE)
 3. ACCESSORY (RED)
 4. LEFT SIDE SENSE (YELLOW)
 5. REAR SENSE (BLACK)
 6. RIGHT SIDE SENSE (GREEN)

*** AP28580 INCLUDES:
AP28575 AND AP28576.

		HWH		I-80 EXIT 267 SOUTH RT 1 MOSCOW, IOWA 52760	
		SCALE 1:3	DATE 26DEC02	DRAWN BY .	
		SYSTEM SCHEMATIC ELEC			
NO.	DATE	REVISION			
THE INFORMATION DISCLOSED ON THIS DRAWING IS CONFIDENTIAL AND MUST NOT BE DISCLOSED OR USED IN ANY MANNER WHICH WILL BE DETRIMENTAL TO THE HWH CORPORATION				DRAWING NUMBER MP889910	