

AP30377

GRAY 12 PIN

1. BLK(W1400) LF CONTROL
2. BLK(W3400) RR CONTROL
3. BLK(W9301) TRAVEL
4. WHT(W6230) GROUND
5. BLK(W8110) PSW DISABLE
6. BLK(W9300) DUMP
7. BLK(W9000) PARK BRAKE
8. N/C
9. BLK(W2400) RF CONTROL
10. BLK(W4400) LR CONTROL
11. BLK(W8600) PUMP RELAY CONTROL
12. BLK(W6121) ACCESSORY

BROWN 12 PIN

1. N/C
2. WHT(W6243) GROUND
3. WHT(W6242) GROUND
4. WHT(W6241) GROUND
5. WHT(W6240) GROUND
6. BLK(W8100) MANIFOLD PRESS SW.
7. BLK(W9000) PARK BRAKE
8. BLK(W4400) LEFT REAR SOLENOID
9. BLK(W2400) RIGHT FRONT SOLENOID
10. BLK(W1400) LEFT FRONT SOLENOID
11. BLK(W3400) RIGHT REAR SOLENOID
12. BLK(W8600) PUMP RELAY CONTROL

GREEN 12 PIN

1. BLK(W5050) CYL EXT. ROOM 1
2. BLK(W5150) CYL RET. ROOM 1
3. BLK(W5051) CYL EXT. ROOM 2
4. BLK(W5151) CYL RET. ROOM 2
5. N/C
6. N/C
7. N/C
8. N/C
9. N/C
10. N/C
11. BLK(W6810) SW. BATTERY
12. BLK(W6810) SW. BATTERY

GRAY 8 PIN

1. BLK(W0400) REAR SENSE
2. BLK(W0300) RIGHT SIDE SENSE
3. BLK(W0200) FRONT SENSE
4. BLK(W0100) LEFT SIDE SENSE
5. N/C
6. N/C
7. N/C
8. BLK(W6122) ACCESSORY

GRAY 4 PIN

1. RED(W6100) BATTERY
2. RED(W6100) BATTERY
3. WHT(W6230) GROUND
4. WHT(W6230) GROUND

		HWH		I-80 EXIT 267 SOUTH RT 1 MOSCOW, IOWA 52760	
		SCALE 1:3	DATE 18MAR03	DRAWN BY .	
		SYSTEM SCHEMATIC ELEC			
NO.	DATE	REVISION			
THE INFORMATION DISCLOSED ON THIS DRAWING IS CONFIDENTIAL AND MUST NOT BE DISCLOSED OR USED IN ANY MANNER WHICH WILL BE DETRIMENTAL TO THE HWH CORPORATION			DRAWING NUMBER MP89038 A/E		

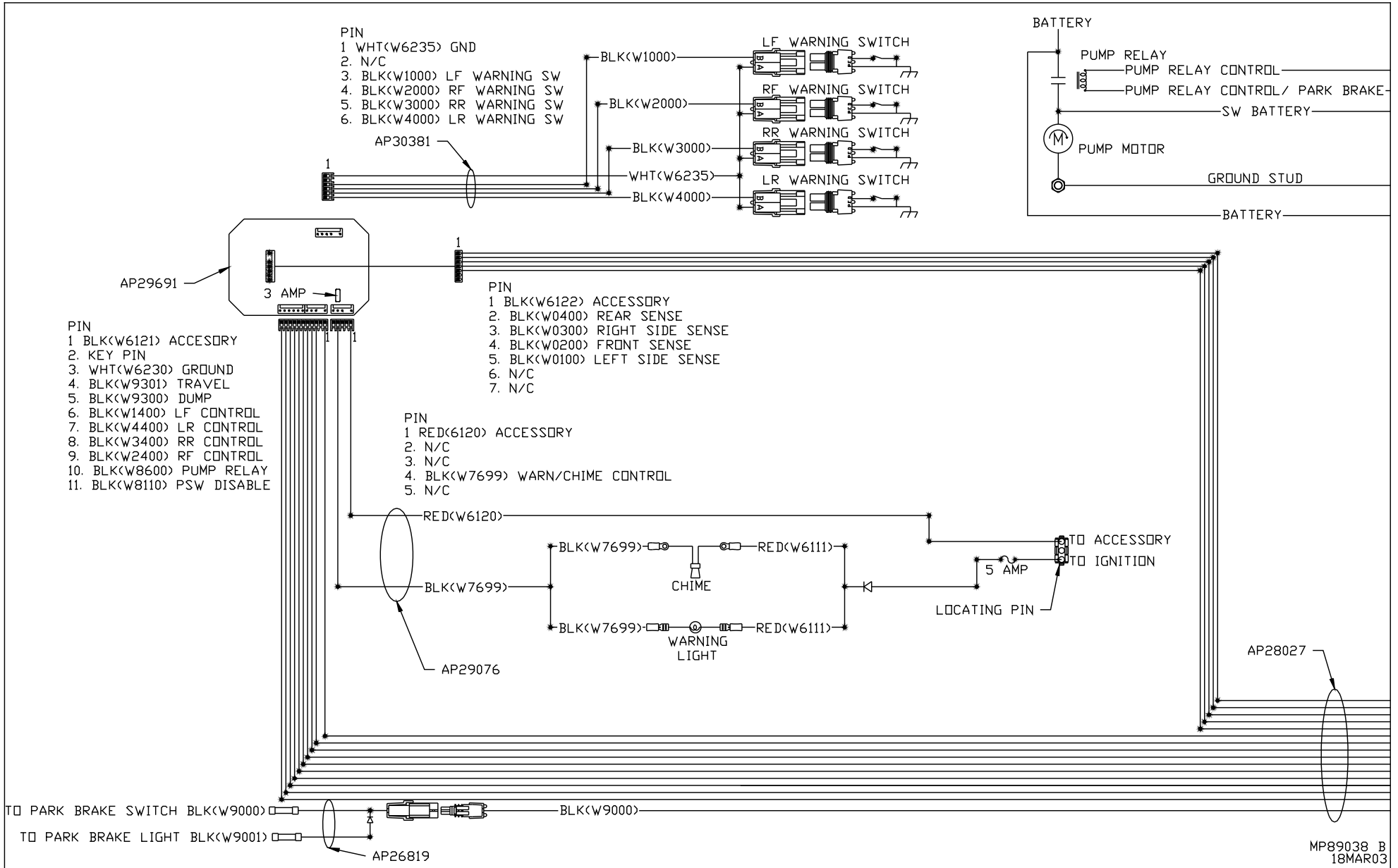

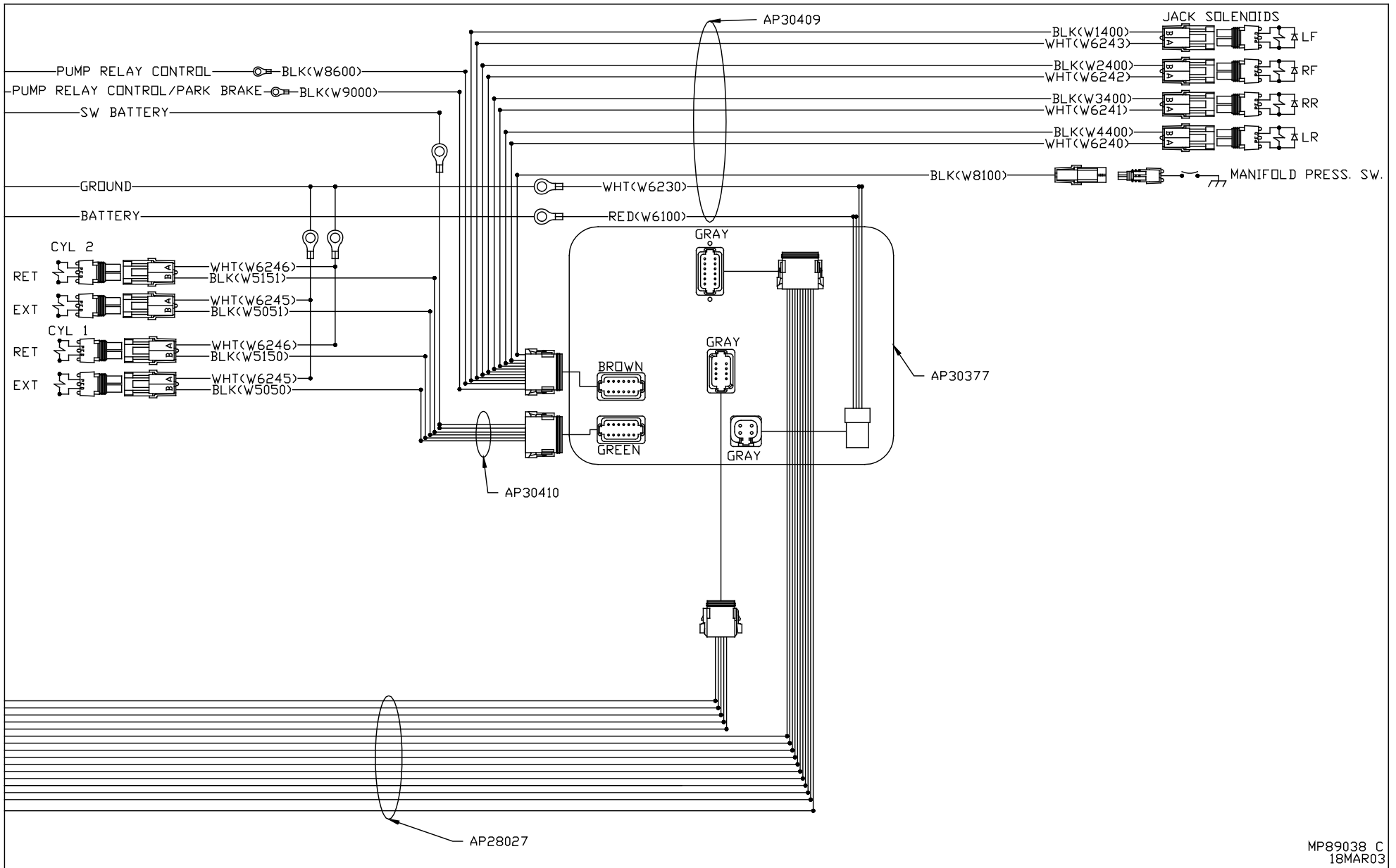

BLACK 12 PIN

1. BLK(W6810) SW. BATT ROOM 1
2. BLK(W5000) EXTEND ROOM 1
3. BLK(W5100) RETRACT ROOM 1
4. BLK(W6811) SW. BATT ROOM 2
5. BLK(W5001) EXTEND ROOM 2
6. BLK(W5101) RETRACT ROOM 2
7. N/C
8. N/C (KEY PIN)
9. N/C
10. BLK(W8601) PUMP
11. RED(W6100) BATTERY
12. N/C (KEY PIN)

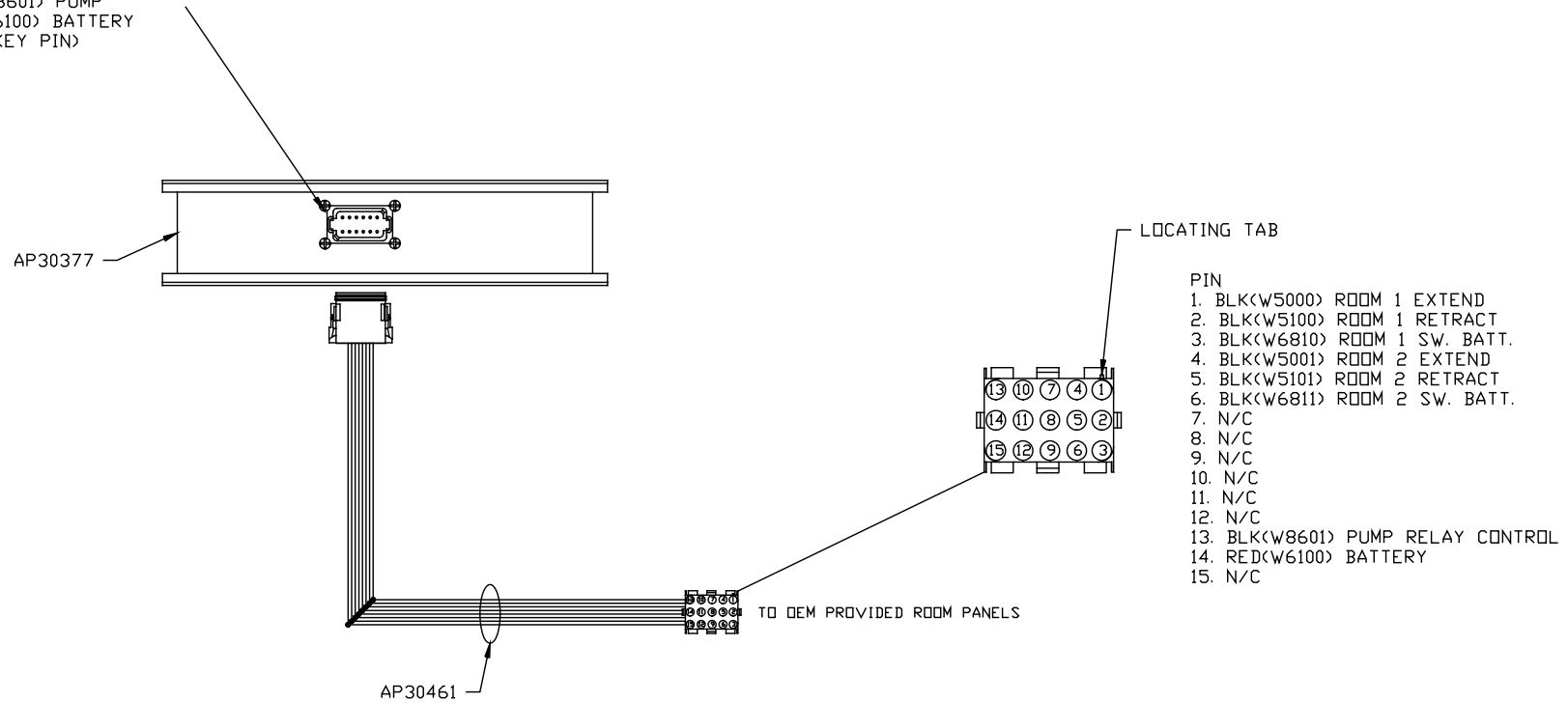

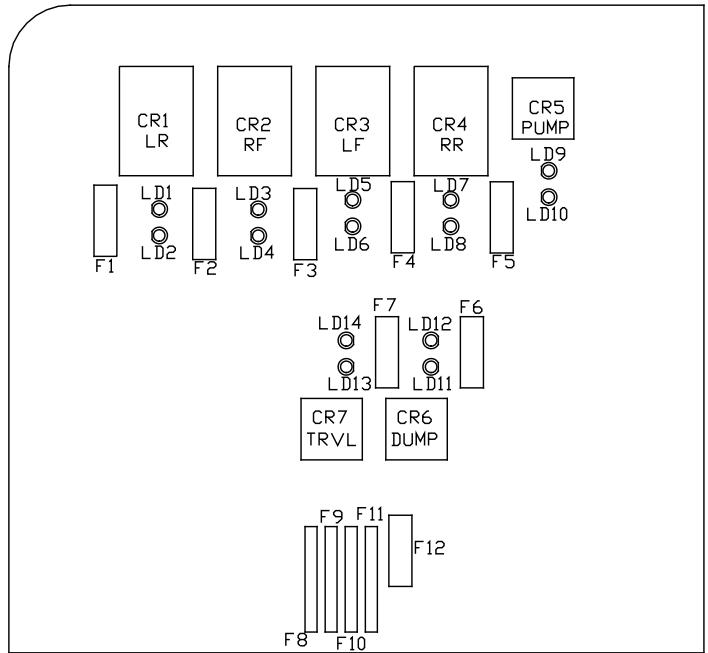

LED #	RATING	DESCRIPTION
F1	15 AMP	LEFT REAR OUTPUT
F2	15 AMP	RIGHT FRONT OUTPUT
F3	15 AMP	LEFT FRONT OUTPUT
F4	15 AMP	RIGHT REAR OUTPUT
F5	5 AMP	PUMP OUTPUT
F6	5 AMP	DUMP OUTPUT
F7	5 AMP	TRAVEL OUTPUT
F8	---	ROOM 1
F9	---	ROOM 2
F10	---	---
F11	---	---
F12	3 AMP	PARK BRAKE

LED #	COLOR	DESCRIPTION
LED 1	YELLOW	LR COIL
LED 2	RED	LR CONTACT
LED 3	YELLOW	RF COIL
LED 4	RED	RF CONTACT
LED 5	YELLOW	LF COIL
LED 6	RED	LF CONTACT
LED 7	YELLOW	RR COIL
LED 8	RED	RR CONTACT
LED 9	YELLOW	PUMP COIL
LED 10	RED	PUMP CONTACT
LED 11	YELLOW	DUMP COIL
LED 12	RED	DUMP CONTACT
LED 13	YELLOW	TRAVEL COIL
LED 14	RED	TRAVEL CONTACT