

ORIENTATION
FRONT →

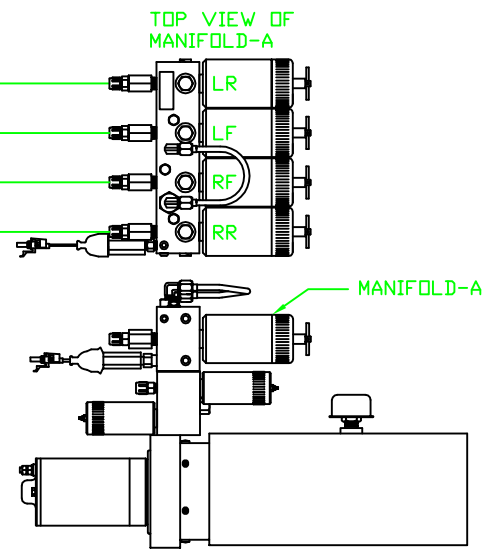
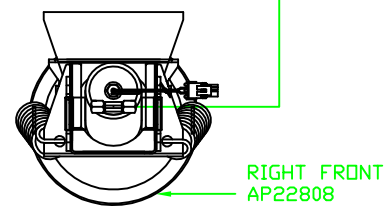
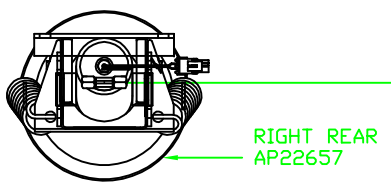
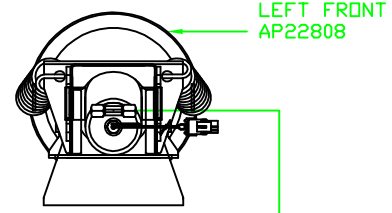
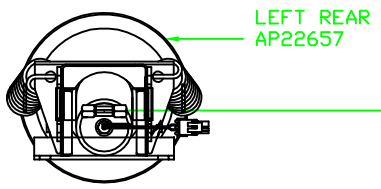

TOP VIEW OF MANIFOLD-A
LR
LF
RF
RR
MANIFOLD-A
SIDE VIEW PUMP/MANIFOLD-AP24800
LOCATION AND ORIENTATION OF PUMP/MANIFOLD ASSEMBLY WILL DIFFER DEPENDING UPON D.E.M.

		HWH I-80 EXIT 267 SOUTH RT 1 MOSCOW, IDWA 52760	
SCALE	DATE 23OCT01	DRAWN BY .	
HYD CONN DIAGRAM			
NO.	DATE	REVISION	
THE INFORMATION DISCLOSED ON THIS DRAWING IS CONFIDENTIAL AND MUST NOT BE DISCLOSED OR USED IN ANY MANNER WHICH WILL BE DETRIMENTAL TO THE HWH CORPORATION			DRAWING NUMBER MP69162 A/B

ORIENTATION
FRONT →

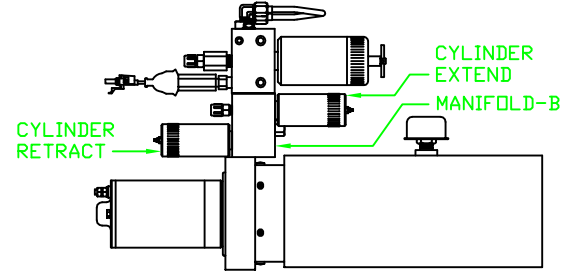
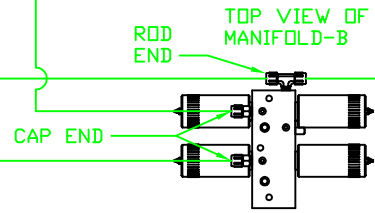
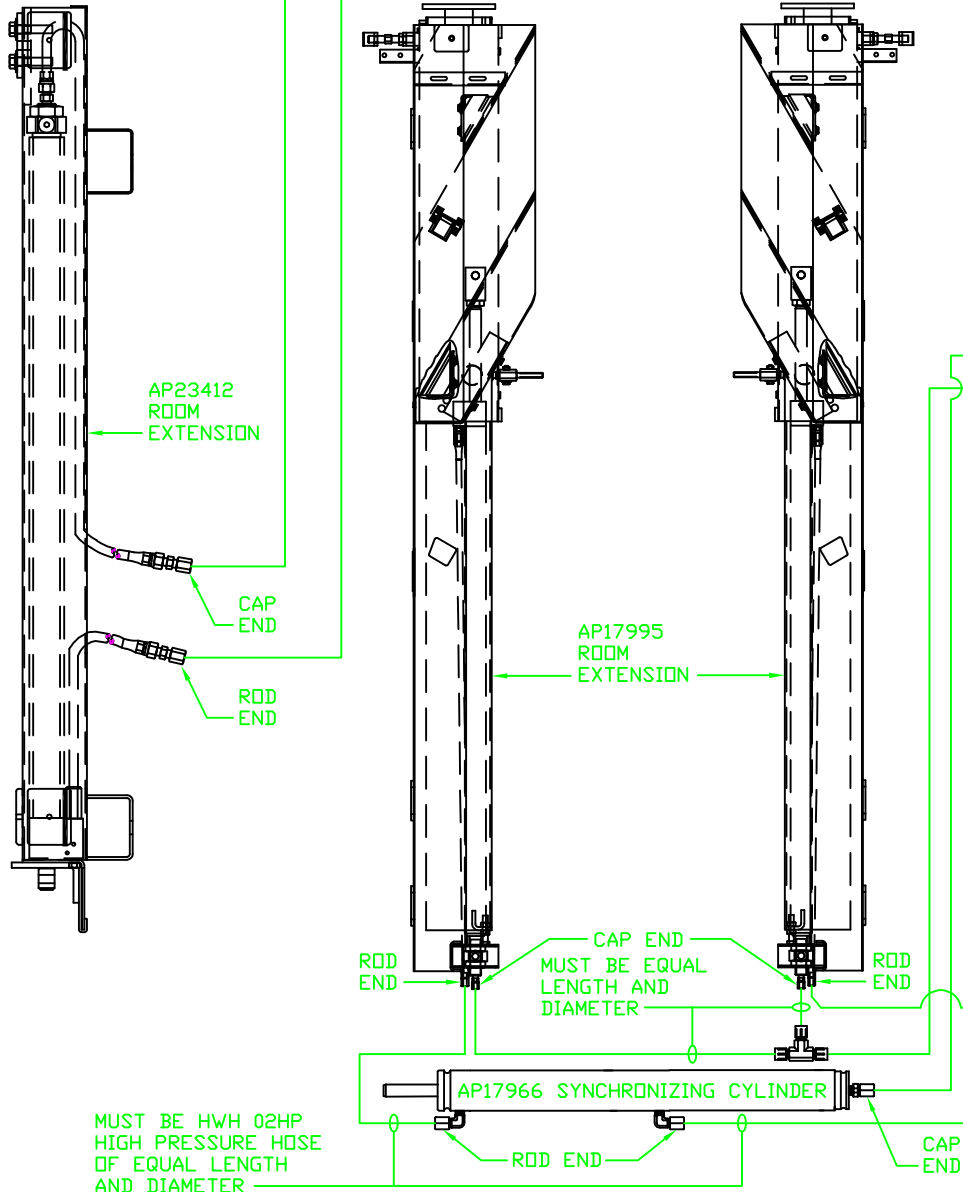

SIDE VIEW PUMP/MANIFOLD-AP24800
LOCATION AND ORIENTATION OF PUMP/MANIFOLD ASSEMBLY WILL DIFFER DEPENDING UPON D.E.M.

2	04SEP02	HOSE ROUTING CHANGED
1	04SEP02	VALVE LABELED EXT-RET
NO.	DATE	REVISION

HWH I-80 EXIT 267 SOUTH
RT 1 MOSCOW, IDWA 52760

SCALE DATE 23OCT01 DRAWN BY .

HYD CONN DIAGRAM

THE INFORMATION DISCLOSED ON THIS DRAWING IS CONFIDENTIAL AND MUST NOT BE DISCLOSED OR USED IN ANY MANNER WHICH WILL BE DETRIMENTAL TO THE HWH CORPORATION

DRAWING NUMBER
MP69162 B/B