

ORIENTATION
← FRONT

TOP VIEW
AP33345
RIGHT FRONT

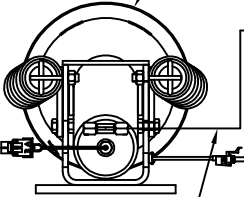

RIGHT
FRONT
HOSE

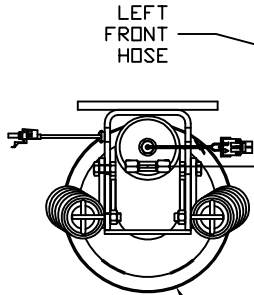

LEFT
FRONT
HOSE

TOP VIEW
AP33345
LEFT FRONT

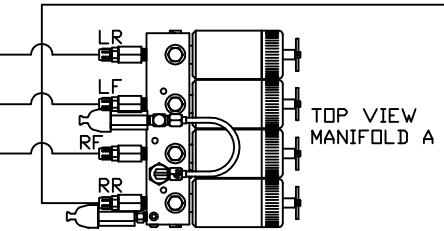

TOP VIEW
MANIFOLD A

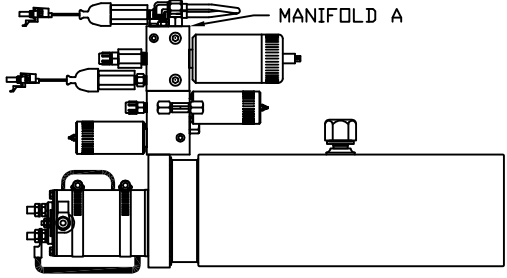

SIDE VIEW OF PUMP/MANIFOLD-AP32523

RIGHT
REAR
HOSE

LEFT
REAR
HOSE

TOP VIEW
AP33345
RIGHT REAR

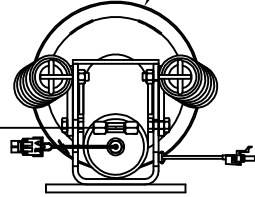

NOTE: CROSS TIES REQUIRED
FOR FRONT AND REAR JACKS

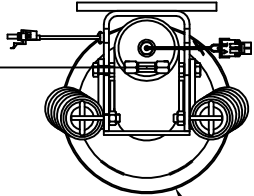

TOP VIEW
AP33345
LEFT REAR

MODEL	HOSE KIT	LF HOSE	RF HOSE	RR HOSE	LR HOSE
R40FD	AP24448	AP2443	AP5352	AP6117	AP5352
S36RD	AP19679	AP2443	AP5352	AP27563	AP4312
S40FD	AP24448	AP2443	AP5352	AP6117	AP5352

LEVELING SYSTEM: AP32519

NO.	DATE	REVISION
1	20JAN14	CORRECTED HOSE ROUTING

THE INFORMATION DISCLOSED ON THIS DRAWING IS CONFIDENTIAL AND MUST NOT BE DISCLOSED OR USED IN ANY MANNER WHICH WILL BE DETRIMENTAL TO THE HWH CORPORATION

HWH I-80 EXIT 267 SOUTH
RT 1 MOSCOW, IOWA 52760

SCALE 1:6 DATE 28APR05 DRAWN BY .

HYD CONN DIAGRAM

WINNEBAGO DRAWING NUMBER
MP69386 A/H

ORIENTATION
 ← FRONT

NOTE: HOSES C MUST BE HIGH PRESSURE HOSES OF EQUAL LENGTH AND DIAMETER

NOTE: HOSES D MUST BE EQUAL LENGTH AND DIAMETER

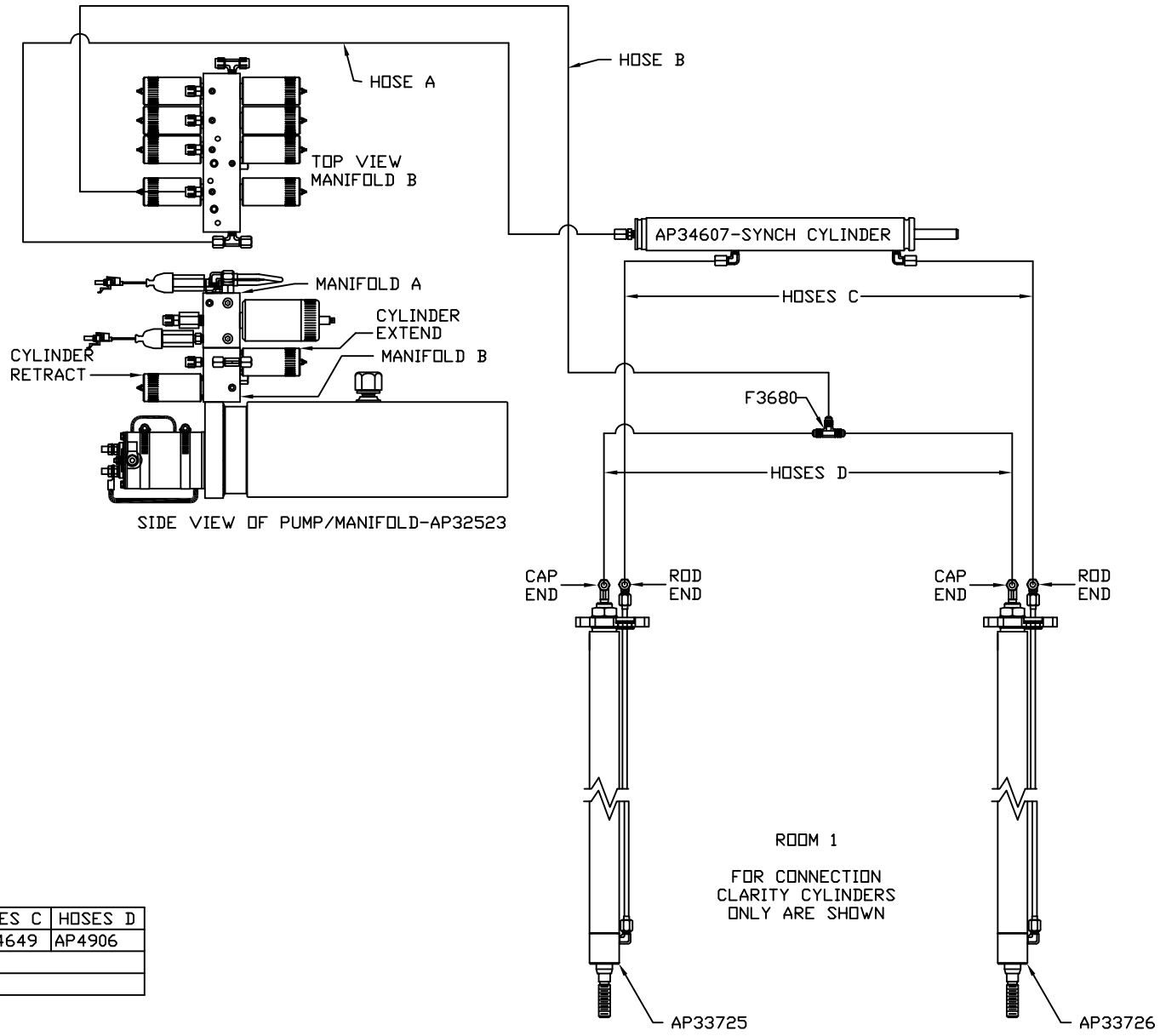

MODEL	HOSE A	HOSE B	HOSES C	HOSES D
R40FD	AP5924	AP11212	AP24649	AP4906
S36RD	SEE MP69386 C			
S40FD	SEE MP69386 C			

ROOM 1
 FOR CONNECTION
 CLARITY CYLINDERS
 ONLY ARE SHOWN

ORIENTATION
← FRONT

NOTE: HOSES C MUST BE HIGH PRESSURE HOSES OF EQUAL LENGTH AND DIAMETER

NOTE: HOSES D MUST BE EQUAL LENGTH AND DIAMETER

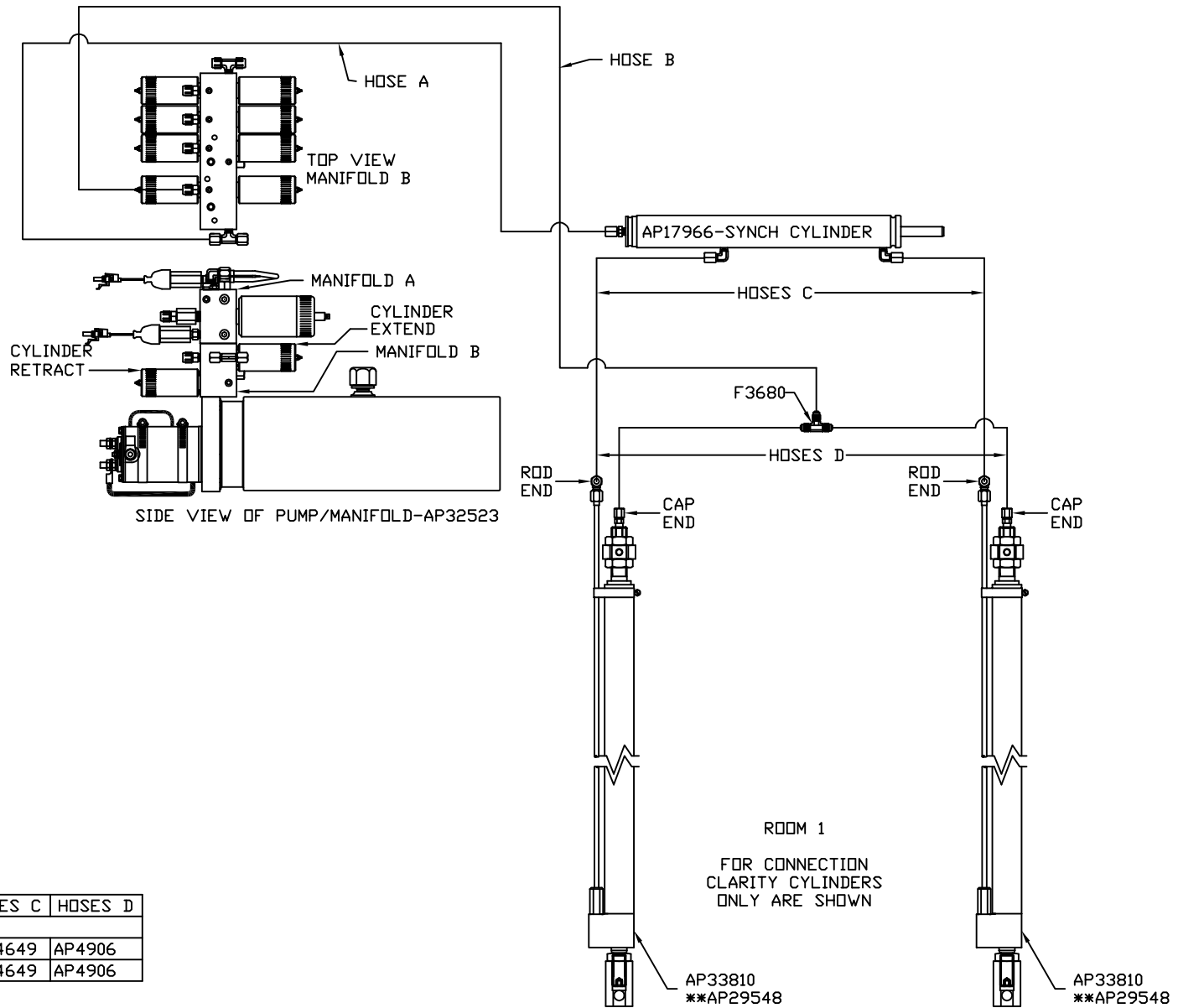

MODEL	HOSE A	HOSE B	HOSES C	HOSES D
R40FD	SEE MP69386 B			
S36RD	AP5924	AP11212	AP24649	AP4906
S40FD	AP5924	AP11212	AP24649	AP4906

** USED ON 2005 PRODUCTION MODELS

ORIENTATION
 ← FRONT

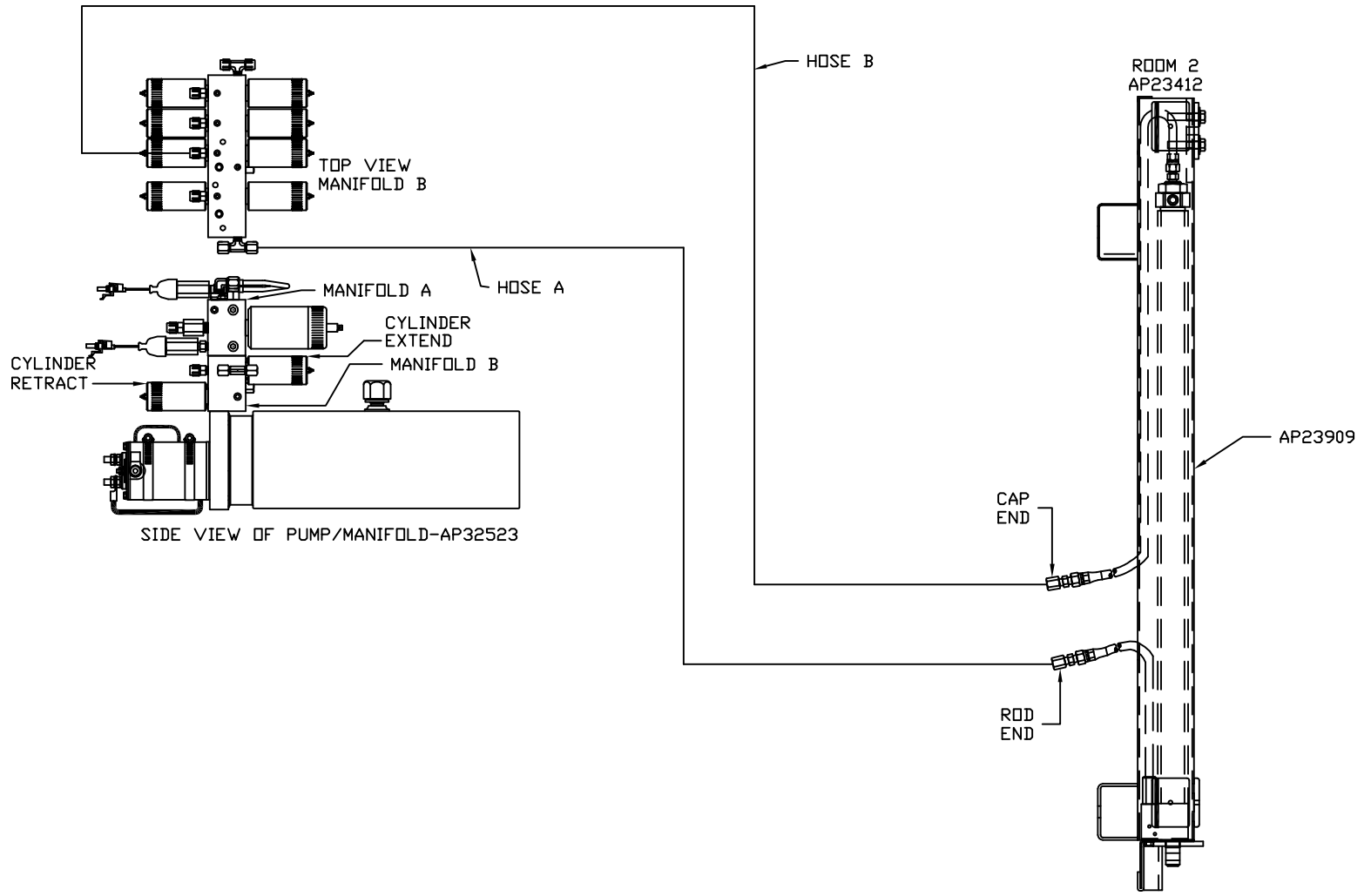

MODEL	HOSE A	HOSE B
R40FD	AP6217	AP5925
S36RD	SEE MP69386 E	
S40FD	AP6217	AP5925

ORIENTATION

← FRONT

NOTE: HOSES C MUST BE HIGH PRESSURE HOSES OF EQUAL LENGTH AND DIAMETER

NOTE: HOSES D MUST BE EQUAL LENGTH AND DIAMETER

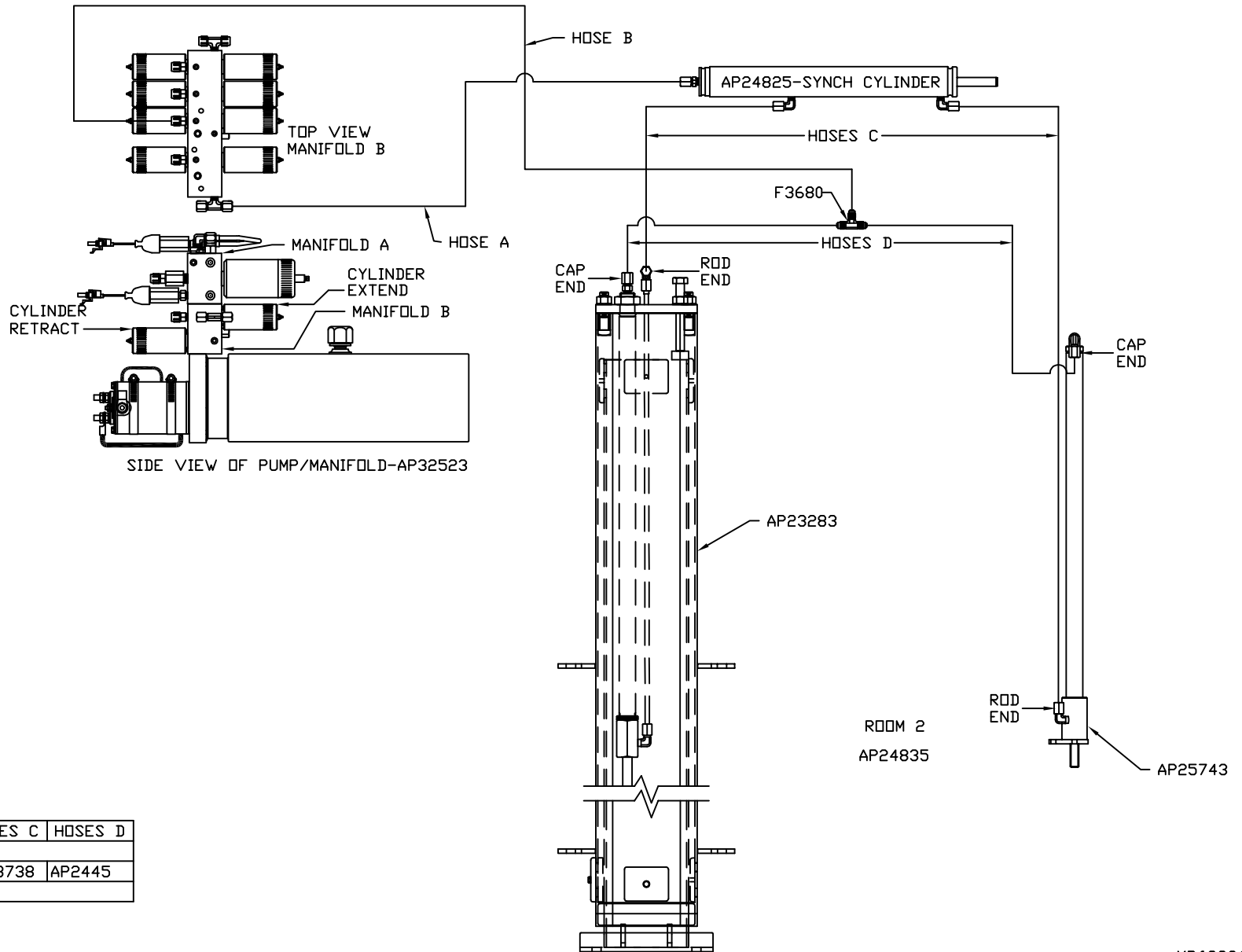

MODEL	HOSE A	HOSE B	HOSES C	HOSES D
R40FD	SEE MP69386 D			
S36RD	AP6217	AP5925	AP23738	AP2445
S40FD	SEE MP69386 D			

ORIENTATION
 ← FRONT

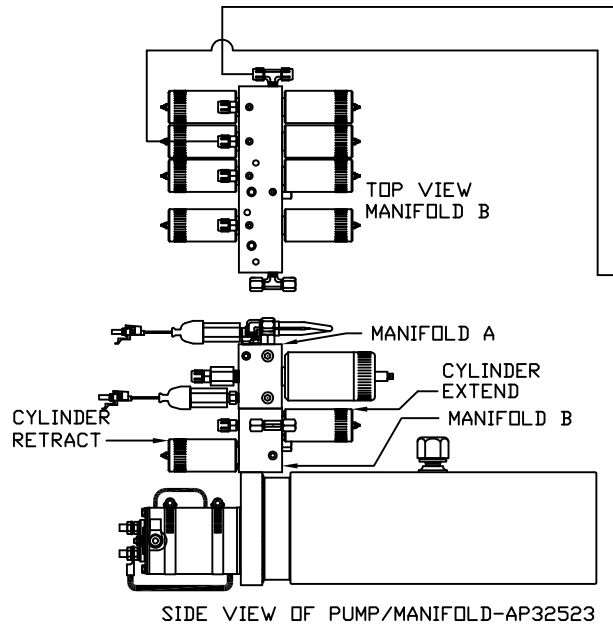

NOTE: HOSES C MUST BE HIGH PRESSURE HOSES OF EQUAL LENGTH AND DIAMETER

NOTE: HOSES D MUST BE EQUAL LENGTH AND DIAMETER

NOTE: AP32781, AP32782, AND HOSES C AND D ARE PART OF THE ROOM EXTENSION MECHANISM. P32743 IS SOLD SEPARATELY

MODEL	HOSE A	HOSE B	HOSES C	HOSES D
R40FD	AP34161	AP32685	AP24635	AP25086
S36RD	AP34161	AP32685	AP24635	AP25086
S40FD	AP34161	AP32685	AP24635	AP25086

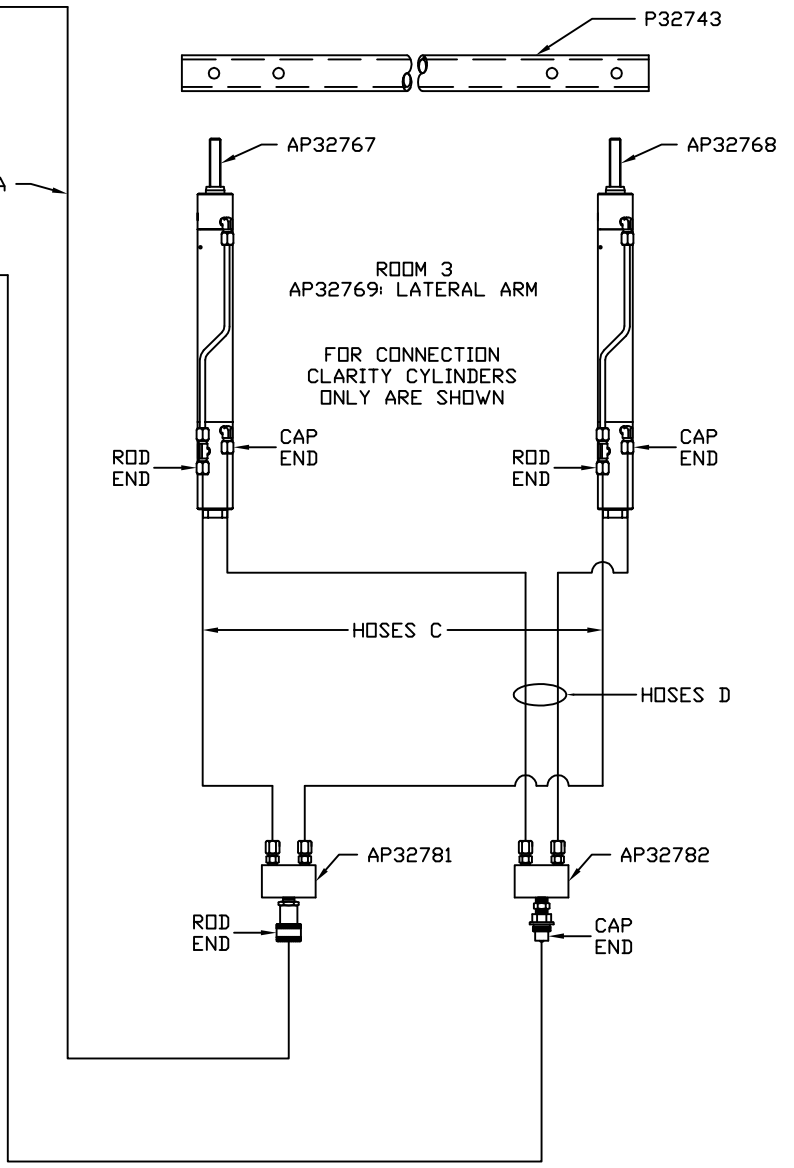

ORIENTATION
← FRONT

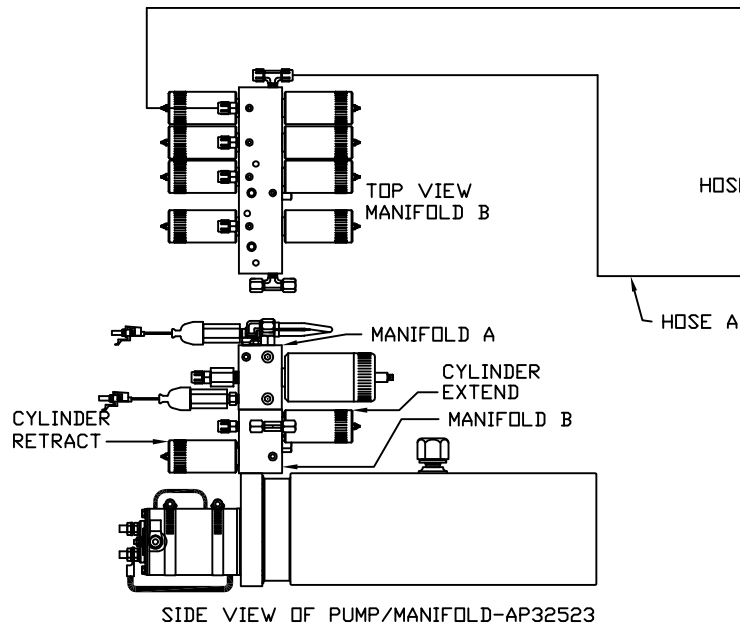

NOTE: HOSES C MUST BE HIGH PRESSURE HOSES OF EQUAL LENGTH AND DIAMETER

NOTE: HOSES D MUST BE EQUAL LENGTH AND DIAMETER

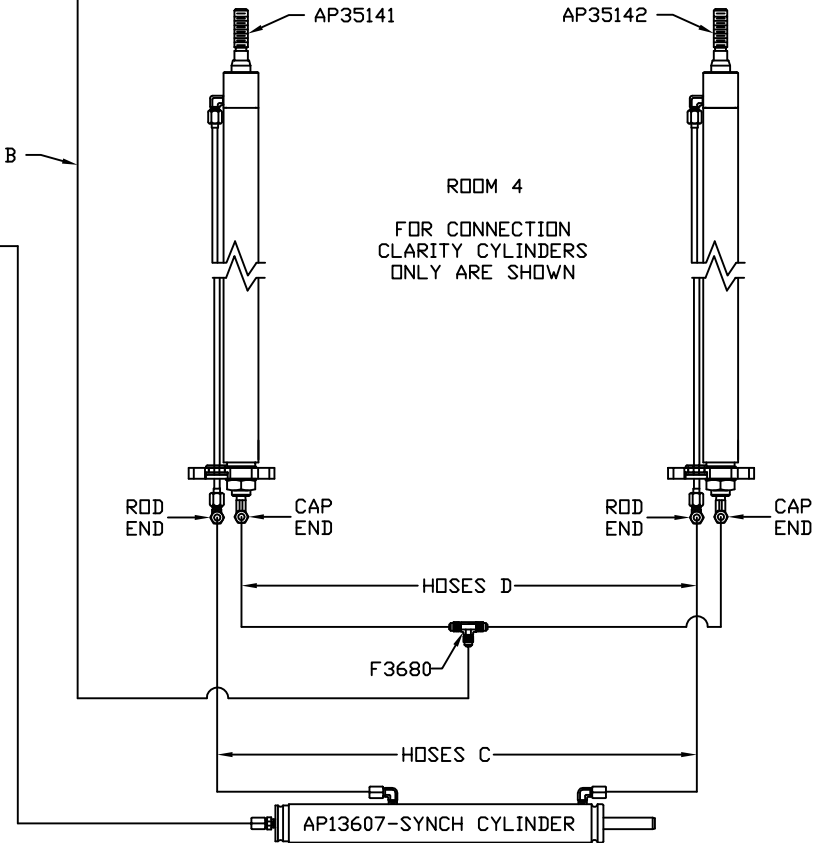

MODEL	HOSE A	HOSE B	HOSES C	HOSES D
R40FD	AP5965	AP7358	AP24649	AP4906
S36RD	SEE MP69386 H			
S40FD	SEE MP69386 H			

ORIENTATION
 ← FRONT

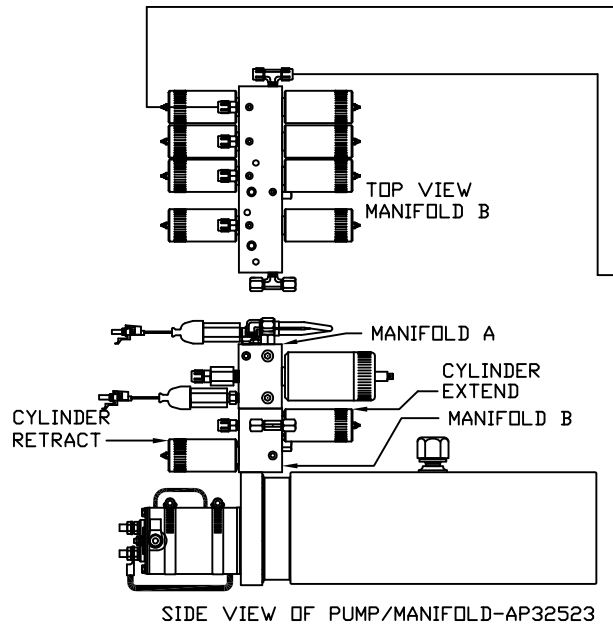

NOTE: HOSES C MUST BE HIGH PRESSURE HOSES OF EQUAL LENGTH AND DIAMETER

NOTE: HOSES D MUST BE EQUAL LENGTH AND DIAMETER

HOSE B
 HOSE A

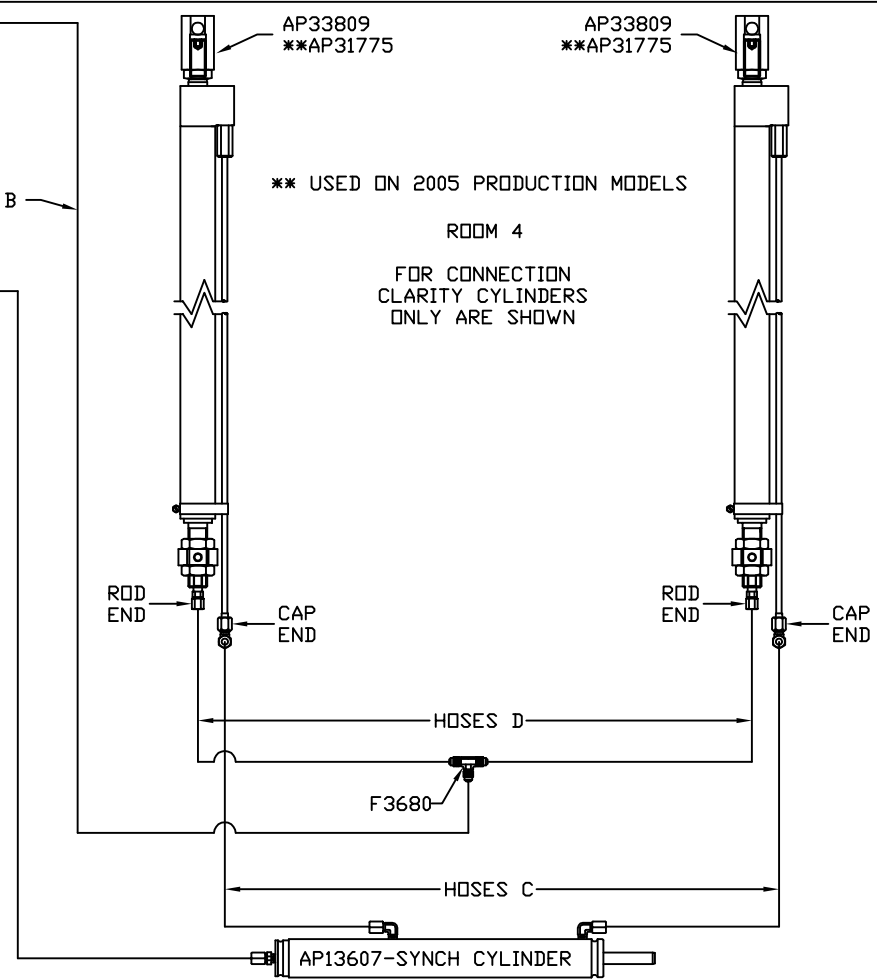

MODEL	HOSE A	HOSE B	HOSES C	HOSES D
R40FD	SEE MP69386 G			
S36RD	AP5965	AP7358	AP24649	AP4906
S40FD	AP5965	AP7358	AP24649	AP4906