

ORIENTATION
← FRONT

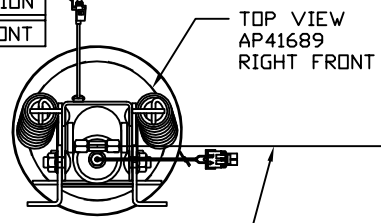

RIGHT FRONT HOSE

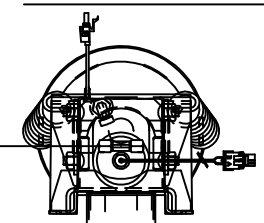

RIGHT REAR HOSE

NOTE: CROSS TIE REQUIRED FOR FRONT JACKS

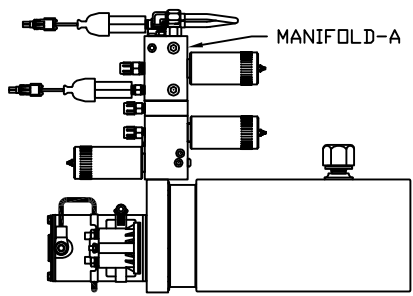
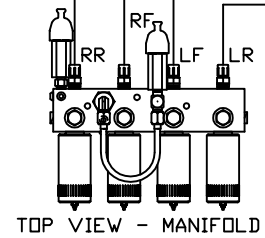

LEFT FRONT HOSE

LEFT REAR HOSE

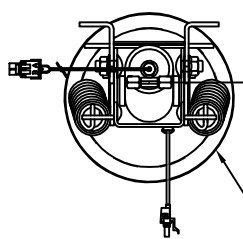

TOP VIEW
AP41689
LEFT FRONT

TOP VIEW
AP41690
REAR JACKS

AP34674
JACK KIT

MODEL	HOSE KIT	LF HOSE	RF HOSE	RR HOSE	LR HOSE
J38N	AP32130	AP4159	AP4062	AP2464	AP4064

NOTE: INSTALLATION MUST CONFORM TO GOOD SHOP PRACTICES, SAE STANDARDS, RVIA STANDARDS, AND OTHER APPLICABLE STANDARDS.

LEVELING SYSTEM: AP41806

NO.	DATE	REVISION

HWH I-80 EXIT 267 SOUTH
RT 1 MOSCOW, IOWA 52760

SCALE 1:6 DATE 14FEB17 DRAWN BY .

HYD CONN DIAGRAM

WINNEBAGO DRAWING NUMBER MP71077 A/D

THE INFORMATION DISCLOSED ON THIS DRAWING IS CONFIDENTIAL AND MUST NOT BE DISCLOSED OR USED IN ANY MANNER WHICH WILL BE DETRIMENTAL TO THE HWH CORPORATION

ORIENTATION
 ← FRONT

MODEL	HOSE A	HOSE B	HOSES C	HOSES D
J38N	AP4665	AP5616	AP24649	AP4906

NOTE: HOSES C MUST BE HIGH PRESSURE HOSES OF EQUAL LENGTH AND DIAMETER

NOTE: HOSES D MUST BE EQUAL LENGTH AND DIAMETER

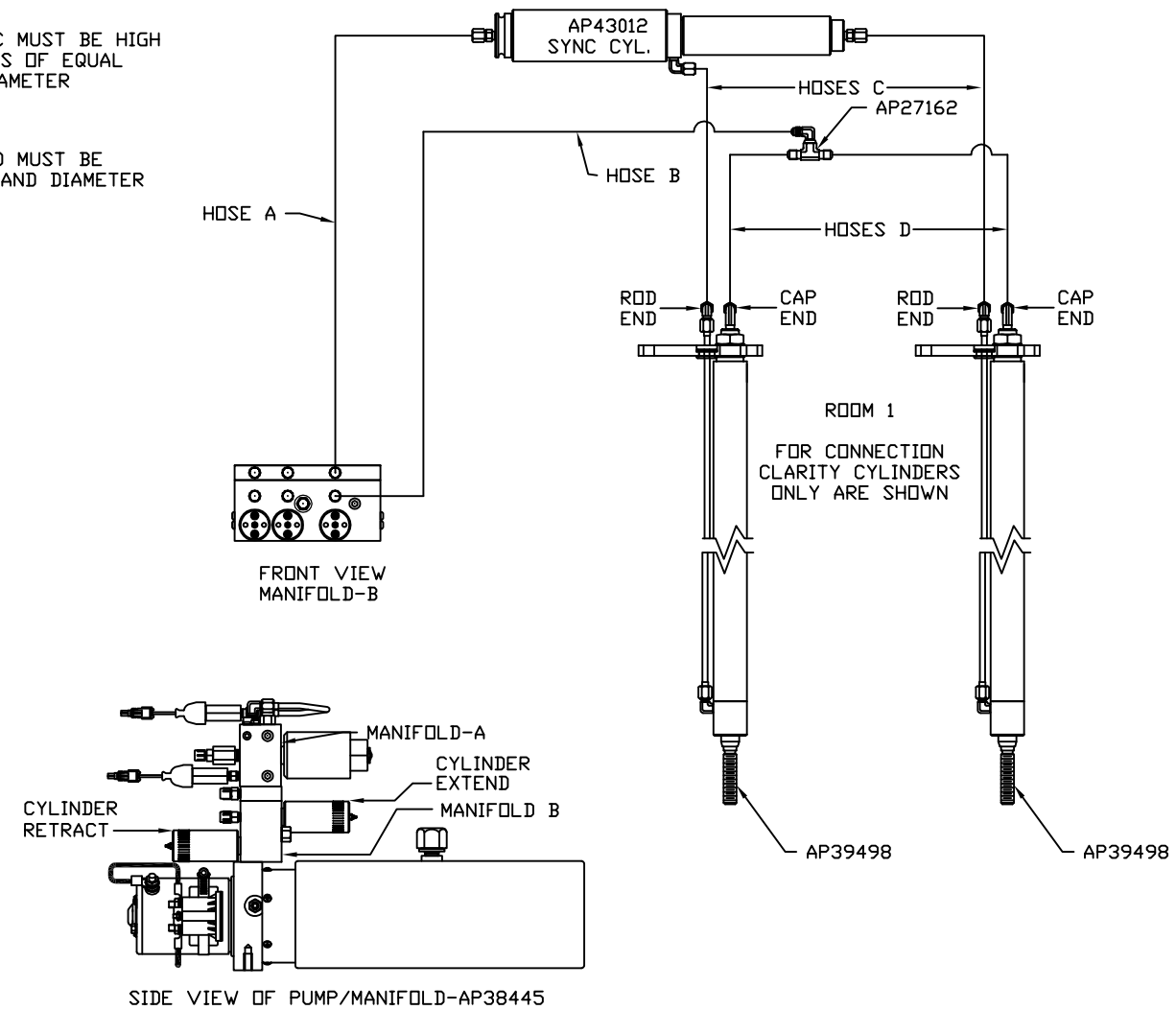

ORIENTATION
 ← FRONT

MODEL	HOSE A	HOSE B
J38N	AP8985	AP5561

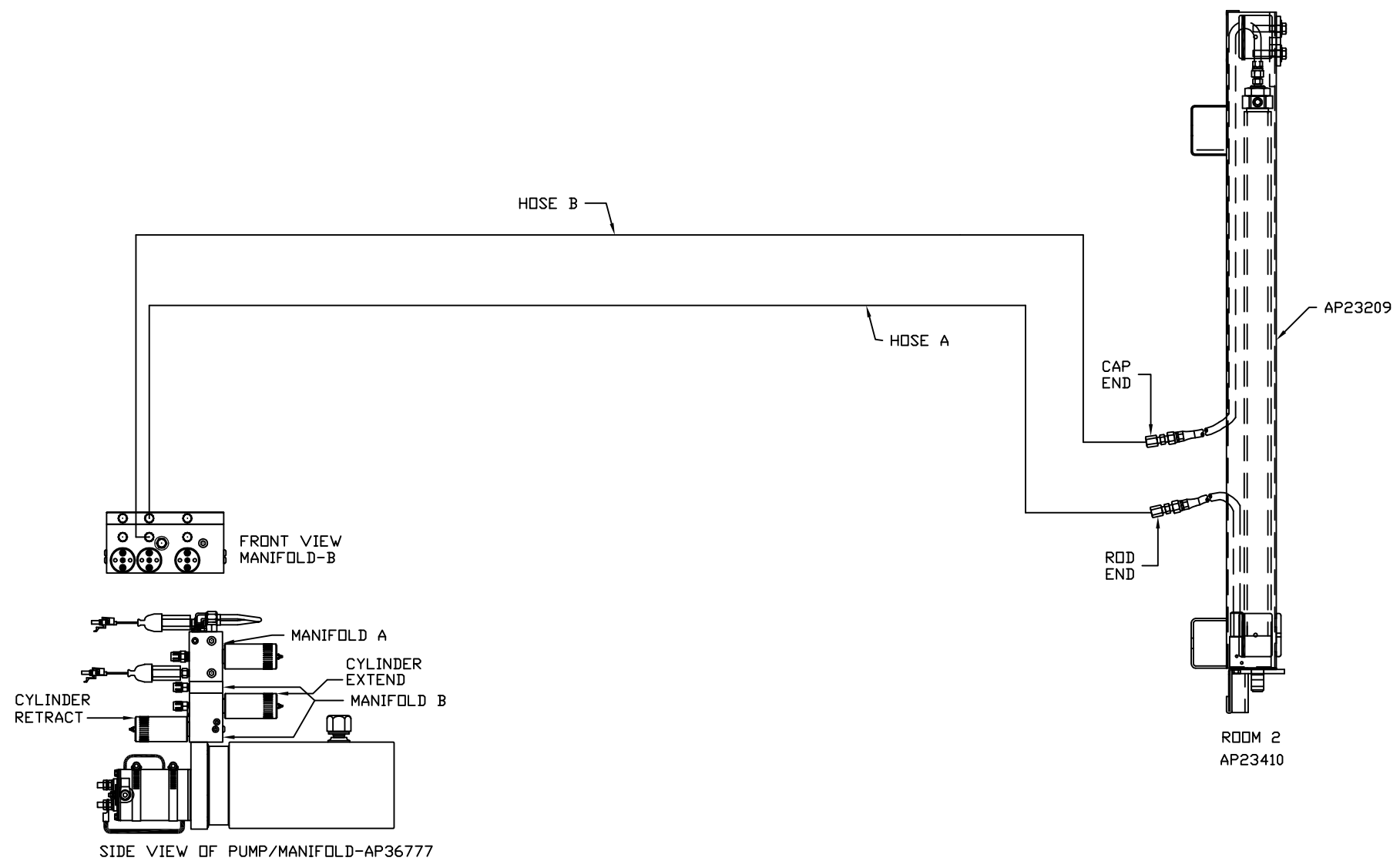

ORIENTATION
 ← FRONT

MODEL	HOSE A	HOSE B	HOSES C	HOSES D
J38N	AP5965	AP7358	AP24649	AP4906

NOTE: HOSES C MUST BE HIGH PRESSURE HOSES OF EQUAL LENGTH AND DIAMETER

NOTE: HOSES D MUST BE EQUAL LENGTH AND DIAMETER

