

- PIN
1. YELLOW CAN HIGH
  2. GREEN CAN LOW
  3. CAN SHIELD
  4. WHT(W6230) GROUND
  5. RED(W6800) SW. BATTERY

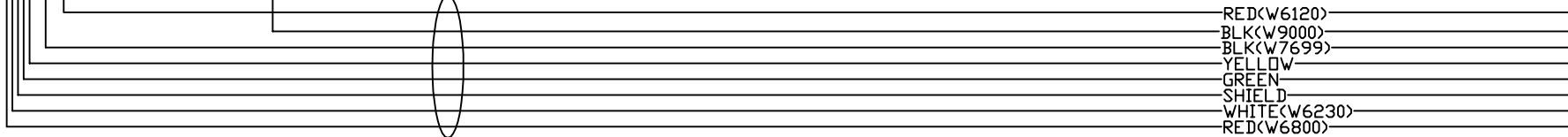
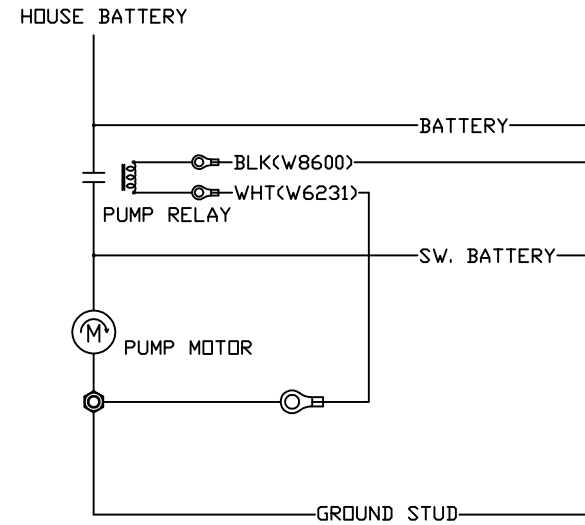
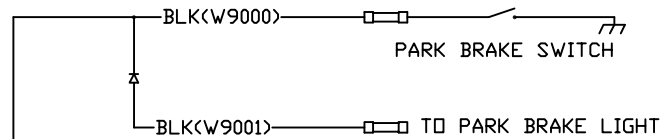
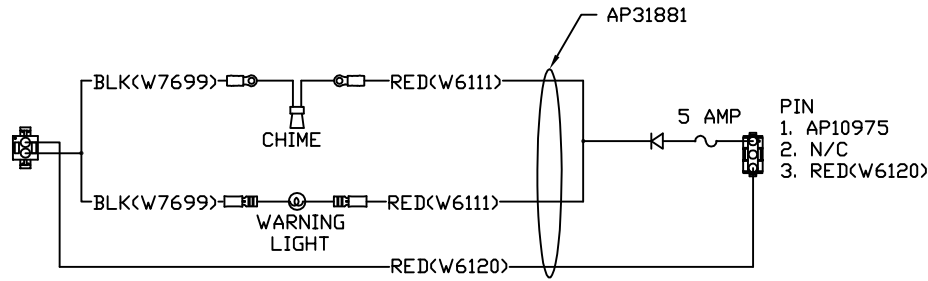

- RED(W6120)
- BLK(W9000)
- BLK(W7699)
- YELLOW
- GREEN
- SHIELD
- WHITE(W6230)
- RED(W6800)

AP31880

		<b>HWH</b>		I-80 EXIT 267 SOUTH RT 1 MOSCOW, IOWA 52760	
		SCALE 1:3	DATE 21MAY04	DRAWN BY .	
		<b>SYSTEM SCHEMATIC ELEC</b>			
NO.	DATE	REVISION			
THE INFORMATION DISCLOSED ON THIS DRAWING IS CONFIDENTIAL AND MUST NOT BE DISCLOSED OR USED IN ANY MANNER WHICH WILL BE DETRIMENTAL TO THE HWH CORPORATION		DRAWING NUMBER MP89251 A/F			

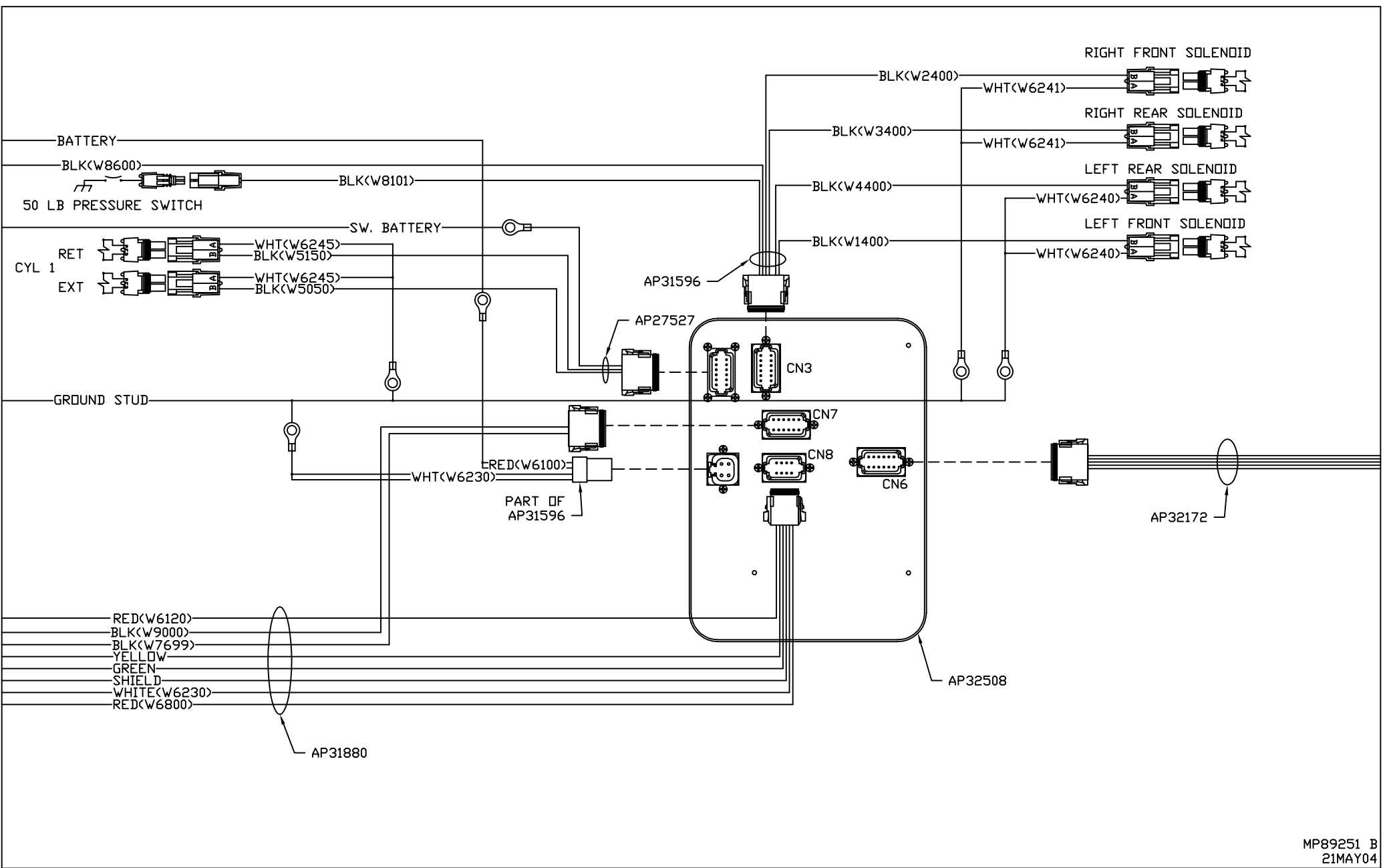

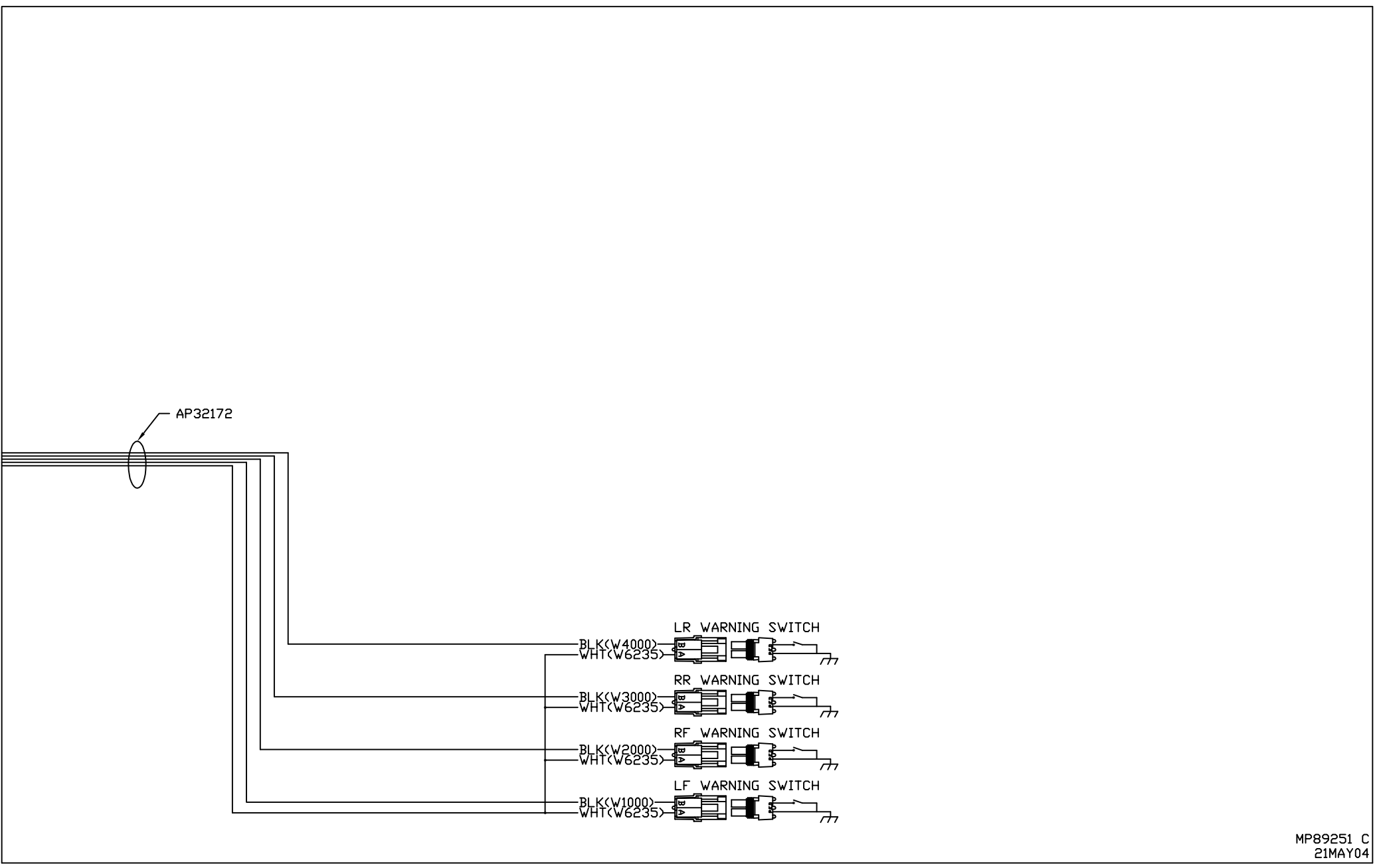

BLACK 12 PIN

- 1. BLK(W6810) SW. BATT ROOM 1
  - 2. BLK(W5000) EXTEND ROOM 1
  - 3. BLK(W5100) RETRACT ROOM 1
  - 4. BLK(W6811) SW. BATT ROOM 2
  - 5. BLK(W5001) EXTEND ROOM 2
  - 6. BLK(W5101) RETRACT ROOM 2
  - 7. N/C
  - 8. N/C (KEY PIN)
  - 9. N/C
  - 10. BLK(W8601) PUMP
  - 11. RED(W6100) BATTERY
  - 12. N/C (KEY PIN)
- NOT USED

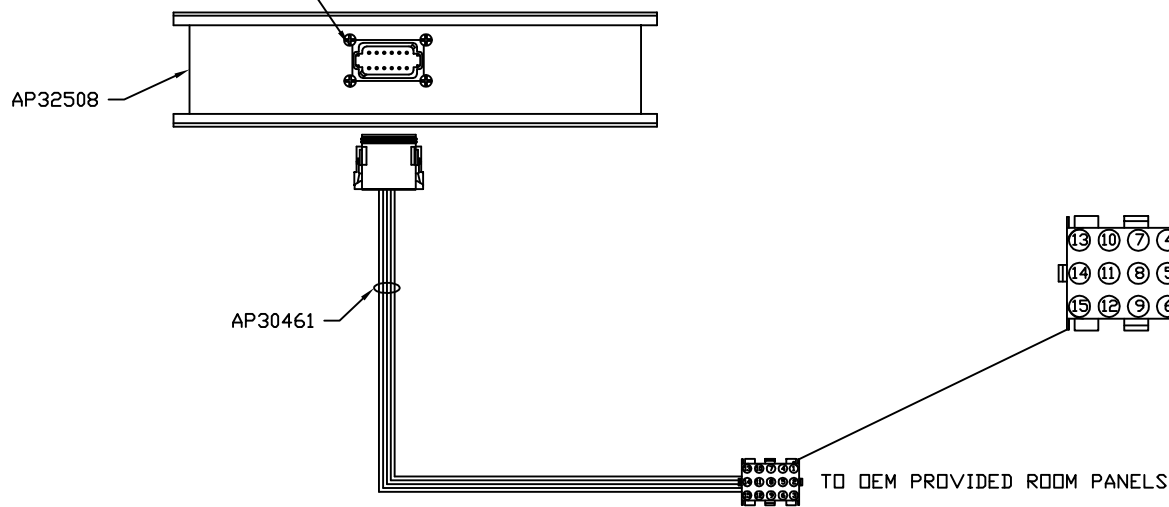

LOCATING TAB

PIN

- 1. BLK(W5000) ROOM 1 EXTEND
  - 2. BLK(W5100) ROOM 1 RETRACT
  - 3. BLK(W6810) ROOM 1 SW. BATT.
  - 4. BLK(W5001) ROOM 2 EXTEND
  - 5. BLK(W5101) ROOM 2 RETRACT
  - 6. BLK(W6811) ROOM 2 SW. BATT.
  - 7. N/C
  - 8. N/C
  - 9. N/C
  - 10. N/C
  - 11. N/C
  - 12. N/C
  - 13. BLK(W8601) PUMP RELAY CONTROL
  - 14. RED(W6100) BATTERY
  - 15. N/C
- NOT USED

GREEN  
PIN  
1 BLK(W5050) CYLINDER 1 EXTEND  
2 BLK(W5150) CYLINDER 1 RETRACT  
3 N/C  
4 N/C  
5 N/C  
6 N/C  
7 N/C  
8 N/C  
9 N/C  
10 N/C  
11 N/C  
12 BLK(W6810) SW. BATTERY

BROWN (CN3)  
PIN  
1 N/C  
2 N/C  
3 BLK(W8101) 50 LB PRESS SW  
4 N/C  
5 BLK(W1400) LF SOLENOID  
6 N/C  
7 N/C  
8 BLK(W4400) LR SOLENOID  
9 BLK(W3400) RR SOLENOID  
10 BLK(W2400) RF SOLENOID  
11 N/C  
12 BLK(W8600) PUMP RELAY CONTROL

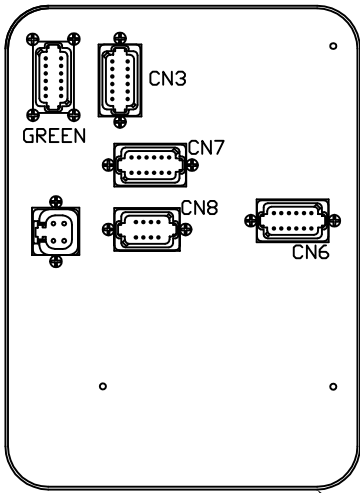

AP32508

BLACK (CN7)  
PIN  
1 N/C  
2 N/C  
3 N/C  
4 N/C  
5 N/C  
6 N/C  
7 BLK(W9000) PARK BRAKE  
8 N/C  
9 N/C  
10 N/C  
11 BLK(W7699) WARN/CHIME CONTROL  
12 N/C

BLACK (CN8)  
PIN  
1 N/C  
2 N/C  
3 RED(W6800) SW BATT  
4 WHT(W6230) GROUND  
5 CAN SHIELD  
6 RED(W6120) ACCESSORY  
7 GREEN  
8 YELLOW

GRAY (CN6)  
PIN  
1 N/C  
2 N/C  
3 BLK(W1000) LF WARN SW  
4 BLK(W2000) RF WARN SW  
5 N/C  
6 N/C  
7 N/C  
8 N/C  
9 BLK(W3000) RR WARN SW  
10 BLK(W4000) LR WARN SW  
11 N/C  
12 WHT(W6235) GROUND

GRAY  
PIN  
1 RED(W6100) BATT  
2 RED(W6100) BATT  
3 WHT(W6230) GROUND  
4 WHT(W6230) GROUND

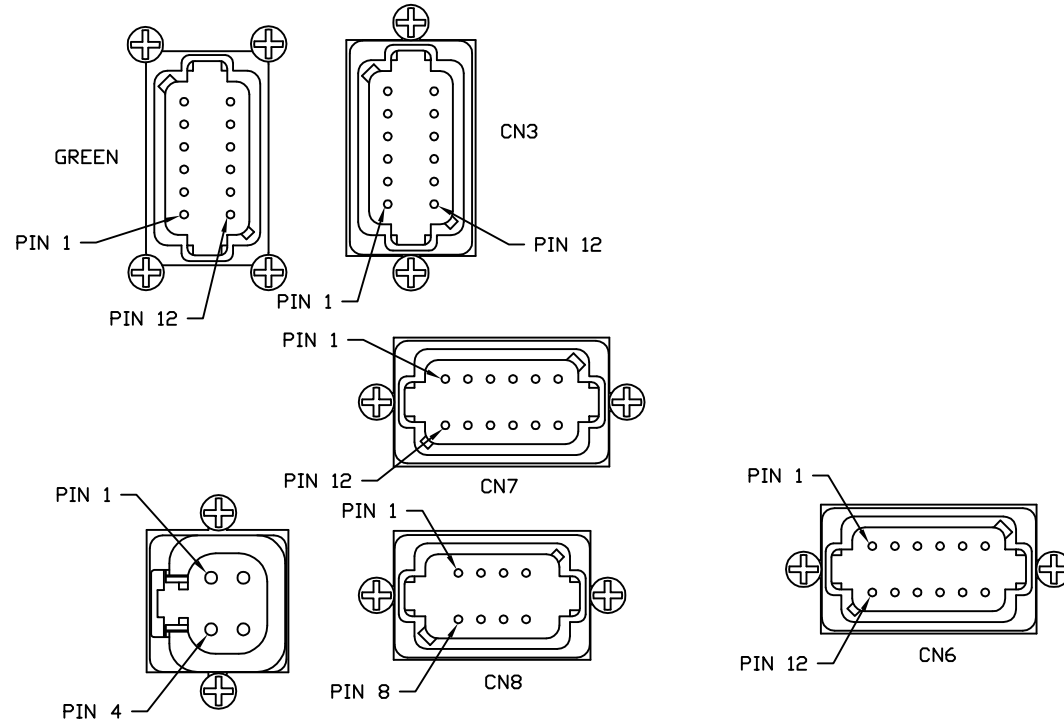

NOTE: WIRE NUMBERS ON THIS SHEET ARE REFERENCED TO HARNESS PLUGS.

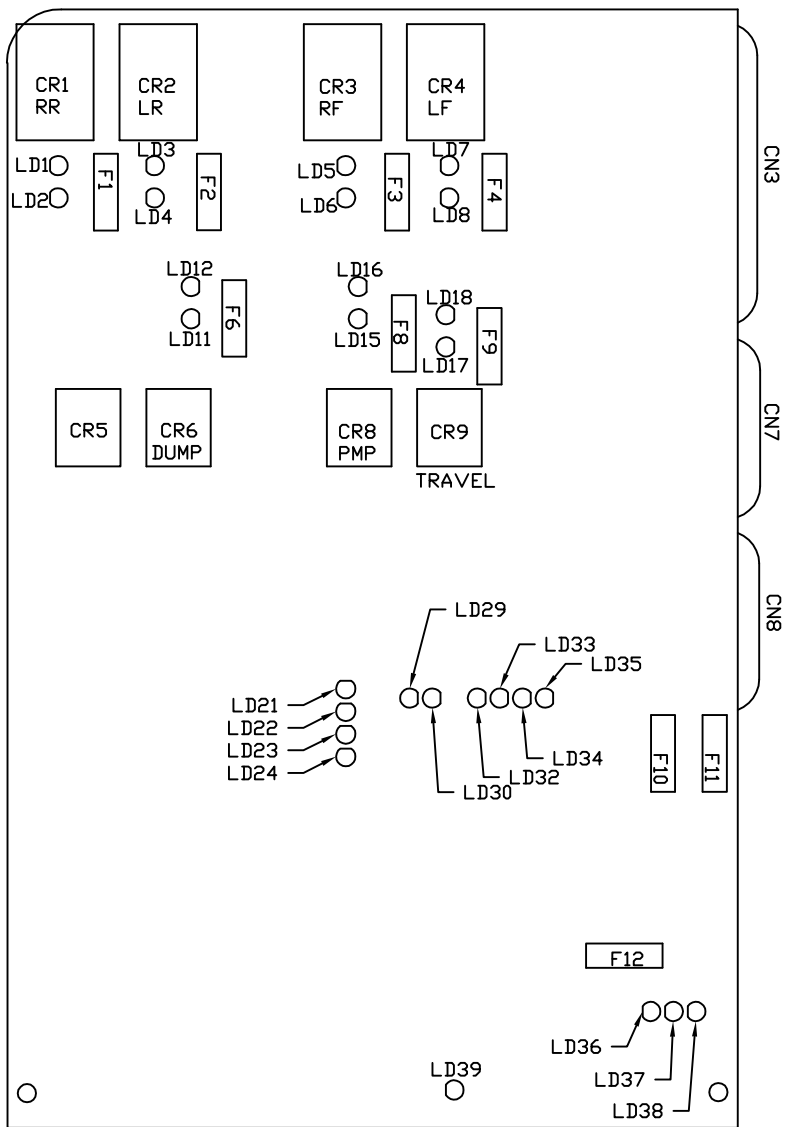

LED #	COLOR	DESCRIPTION
LED 1	YELLOW	RR COIL
LED 2	RED	RR CONTACT
LED 3	YELLOW	LR COIL
LED 4	RED	LR CONTACT
LED 5	YELLOW	RF COIL
LED 6	RED	RF CONTACT
LED 7	YELLOW	LF COIL
LED 8	RED	LF CONTACT
LED 9	YELLOW	---
LED 10	RED	---
LED 11	YELLOW	DUMP COIL
LED 12	RED	DUMP CONTACT
LED 13	---	---
LED 14	---	---
LED 15	YELLOW	PUMP COIL
LED 16	RED	PUMP CONTACT
LED 17	YELLOW	TRAVEL COIL
LED 18	RED	TRAVEL CONTACT
LED 19	---	---
LED 20	---	---
LED 21	YELLOW	LF WARN SW
LED 22	YELLOW	RF WARN SW
LED 23	YELLOW	RR WARN SW
LED 24	YELLOW	LR WARN SW
LED 25	---	---
LED 26	---	---
LED 27	---	---
LED 28	---	---
LED 29	RED	NOT USED
LED 30	YELLOW	NOT USED
LED 31	---	---
LED 32	RED	MASTER WARNING CONTROL
LED 33	GREEN	50 LB PSW INPUT
LED 34	RED	JACK INTERRUPT
LED 35	RED	PARK BRAKE
LED 36	RED	BOARD ENABLED
LED 37	RED	ACCESSORY IN
LED 38	RED	ACCESSORY OUT
LED 39	RED	LINK LIGHT

FUSE	RATING	DESCRIPTION
F1	15 AMP	RR OUTPUT
F2	15 AMP	LR OUTPUT
F3	15 AMP	RF OUTPUT
F4	15 AMP	LF OUTPUT
F5	---	---
F6	5 AMP	DUMP
F7	---	---
F8	5 AMP	PUMP OUTPUT
F9	5 AMP	TRAVEL OUTPUT
F10	7.5 AMP	ACC INPUT
F11	3 AMP	WARN LITE SUPPLY
F12	10 AMP	ACC OUTPUT