

FRONT VIEW - AP58598

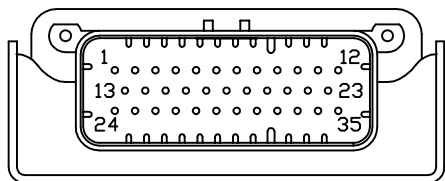

- PIN
1. BLK(W9000) - PARK BRAKE
 2. N/C
 3. BLK(W8101) - 50 LB. PRESSURE SWITCH
 4. BLK(W0100) - LEFT SIDE SENSE
 5. BLK(W0400) - REAR SENSE
 6. BLK(W3000) - RIGHT REAR JACK WARNING SWITCH
 7. BLK(W2200) - RIGHT FRONT JACK PRESSURE SWITCH
 8. N/C
 9. BLK(W8601) - GEN SLIDE PUMP REQUEST
 10. N/C
 11. WHT(W6235) - WARNING SWITCH GROUND
 12. N/C
 13. RED(W6110) - IGNITION SENSE
 14. N/C
 15. N/C
 16. BLK(W0300) - RIGHT SIDE SENSE
 17. BLK(W2000) - RIGHT FRONT JACK WARNING SWITCH
 18. BLK(W1200) - LEFT FRONT JACK PRESSURE SWITCH
 19. N/C
 20. WHT(W6230) - TOUCH PANEL GROUND
 21. CAN SHIELD
 22. YELLOW - CAN HIGH
 23. GREEN - CAN LOW
 24. N/C
 25. BLK(W4200) - LEFT REAR JACK PRESSURE SWITCH
 26. BLK(W8100) - 3000 LB. PRESSURE SWITCH
 27. BLK(W0200) - FRONT SENSE
 28. BLK(W1000) - LEFT FRONT JACK WARNING SWITCH
 29. BLK(W4000) - LEFT REAR JACK WARNING SWITCH
 30. BLK(W3200) - RIGHT REAR JACK PRESSURE SWITCH
 31. N/C
 32. WHT(W6231) - LEVEL SENSOR GROUND
 33. RED(W6121) - LEVEL SENSOR POWER
 34. RED(W6801) - TOUCH PANEL POWER
 35. RED(W6105) - OEM SUPPLIED 5A BATTERY POWER

NOTE: WIRE NUMBERS ON THIS SHEET ARE REFERENCED TO HARNESS PLUGS.

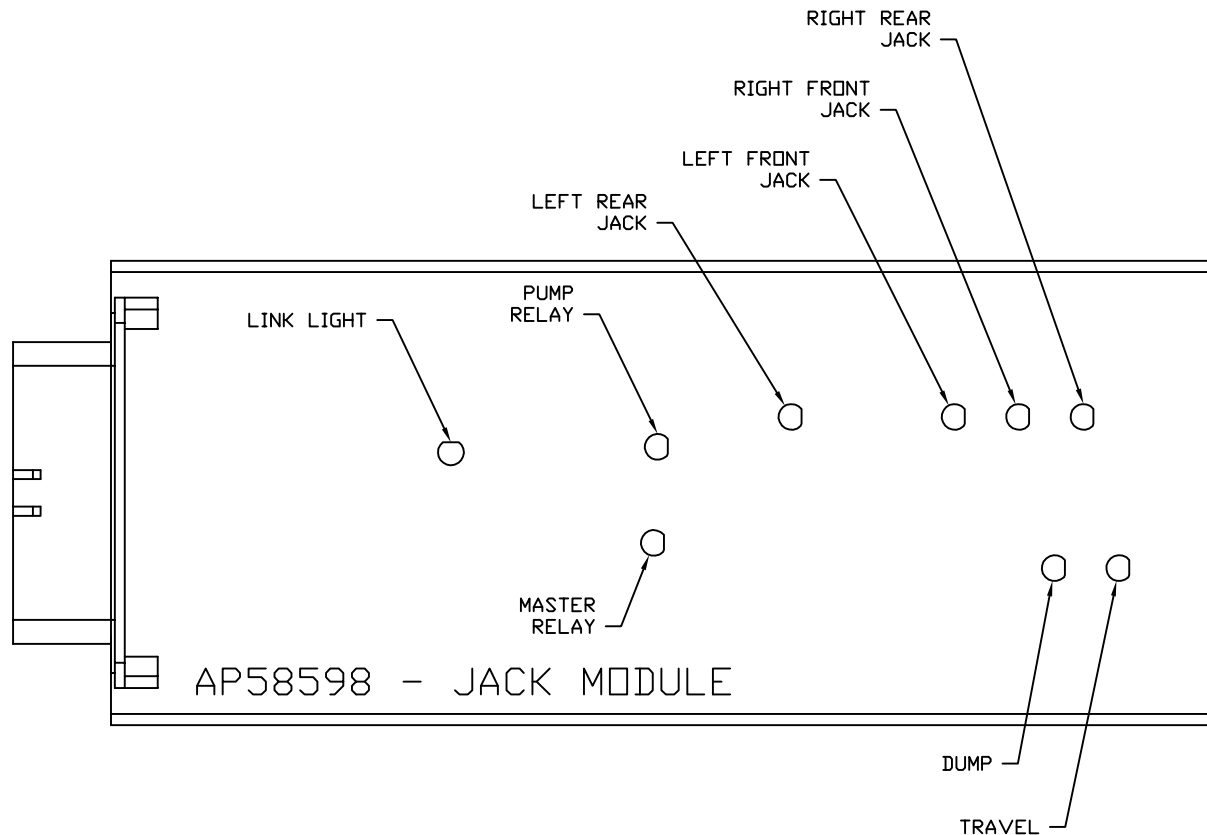

NOTE: INSTALLATION MUST CONFORM TO GOOD SHOP PRACTICES, SAE STANDARDS, RVIA STANDARDS, AND OTHER APPLICABLE STANDARDS.

		HWH		I-80 EXIT 267 SOUTH RT 1 MOSCOW, IOWA 52760	
		SCALE 1:3	DATE 02MAY19	DRAWN BY .	
		SYSTEM SCHEMATIC ELEC			
NO.	DATE	REVISION			
THE INFORMATION DISCLOSED ON THIS DRAWING IS CONFIDENTIAL AND MUST NOT BE DISCLOSED OR USED IN ANY MANNER WHICH WILL BE DETRIMENTAL TO THE HWH CORPORATION			DRAWING NUMBER MP91456 A/H		

FRONT VIEW - AP58701-02

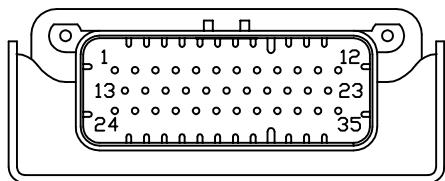

- PIN
- 1. N/C
 - 2. N/C
 - 3. N/C
 - 4. N/C
 - 5. N/C
 - 6. N/C
 - 7. N/C
 - 8. N/C
 - 9. N/C
 - 10. N/C
 - 11. N/C
 - 12. N/C
 - 13. N/C
 - 14. N/C
 - 15. N/C
 - 16. N/C
 - 17. BLK(W5700) - ROOM 1 OUT LIMIT SWITCH
 - 18. N/C
 - 19. BLK(W5000) - ROOM 1 EXTEND
 - 20. N/C
 - 21. CAN SHIELD
 - 22. YELLOW - CAN HIGH
 - 23. GREEN - CAN LOW
 - 24. N/C
 - 25. N/C
 - 26. N/C
 - 27. N/C
 - 28. BLK(W5703) - ROOM 1 IN LIMIT SWITCH
 - 29. N/C
 - 30. BLK(W5100) - ROOM 1 RETRACT
 - 31. N/C
 - 32. WHT(W6236) - LIMIT SWITCH GROUND
 - 33. RED(W6101) - ROOM SWITCH POWER
 - 34. N/C
 - 35. RED(W6105) - OEM SUPPLIED 5A BATTERY

NOTE: WIRE NUMBERS ON THIS SHEET ARE REFERENCED TO HARNESS PLUGS.

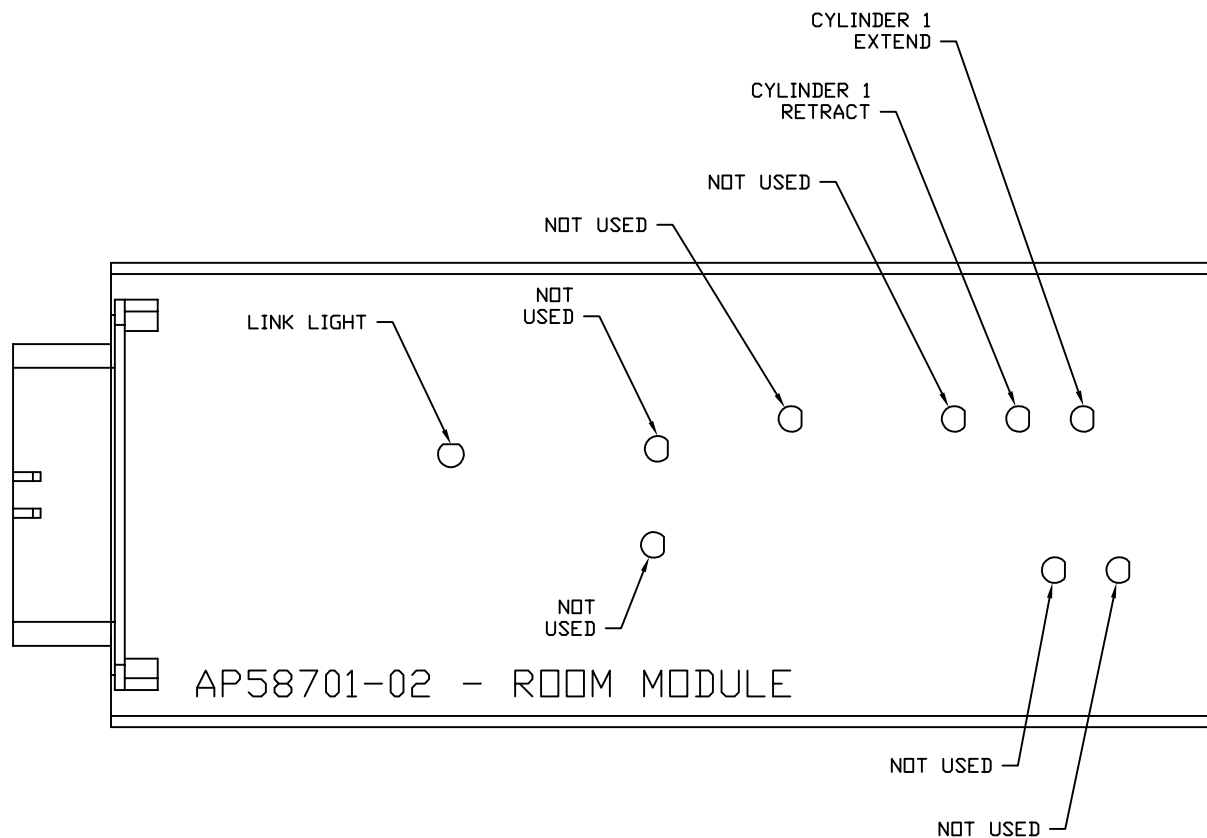

NOTE: INSTALLATION MUST CONFORM TO GOOD SHOP PRACTICES, SAE STANDARDS, RVIA STANDARDS, AND OTHER APPLICABLE STANDARDS.

(BROWN)
PIN

- 1 WHT(W6231) - GROUND
- 2 BLK(W5730) - STEP MASTER SWITCH
- 3 BLK(W5731) - MAGNETIC DOOR SWITCH
- 4 BLK(W5732) - CURB FEELER SWITCH
- 5 BLK(W5733) - SHIN GUARD SWITCH
- 6 WHT(W6230) - GROUND
- 7 RED(W6800) - +12V TO STEP MASTER SWITCH
- 8 BLK(W5700) - STEP IN LIMIT SWITCH
- 9 BLK(W5702) - STEP OUT LIMIT SWITCH
- 10 N/C
- 11 BLK(W7540) - OVERRIDE SWITCH
- 12 RED(W6801) - +12V TO MAGNETIC DOOR SWITCH

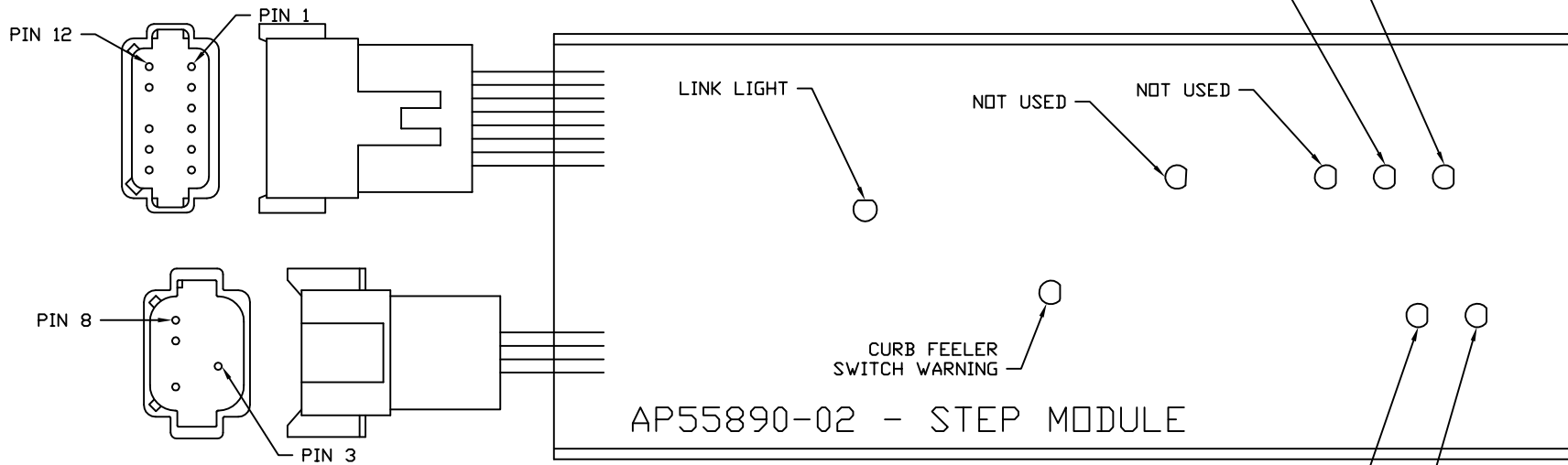

(BLACK)
PIN

- 1 N/C
- 2 N/C
- 3 RED(W6105) - OEM SUPPLIED 5A BATTERY
- 4 N/C
- 5 CAN SHIELD
- 6 N/C
- 7 GREEN - CAN LOW
- 8 YELLOW - CAN HI

NOTE: INSTALLATION MUST CONFORM TO GOOD SHOP PRACTICES, SAE STANDARDS, RVIA STANDARDS, AND OTHER APPLICABLE STANDARDS.

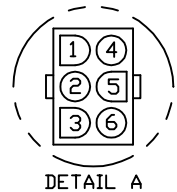

TO OEM PROVIDED
PILOT DUMP CONNECTION

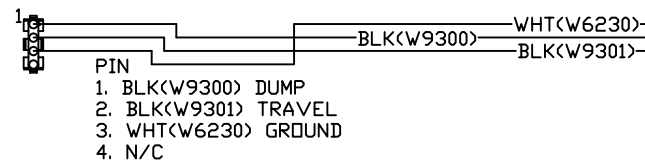

- PIN
 1. N/C
 2. N/C
 3. N/C
 4. N/C
 5. BLK(W7699) WARNING LED/ALARM CONTROL
 6. N/C

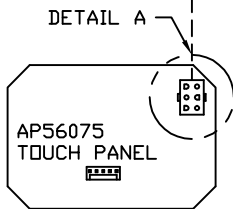

- PIN
 1. YELLOW CAN HI
 2. GREEN CAN LOW
 3. CAN SHIELD
 4. WHT(W6230) GROUND
 5. RED(W6800) POWER

120 OHM
TERMINATION
RESISTOR

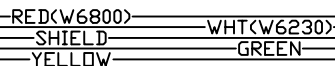
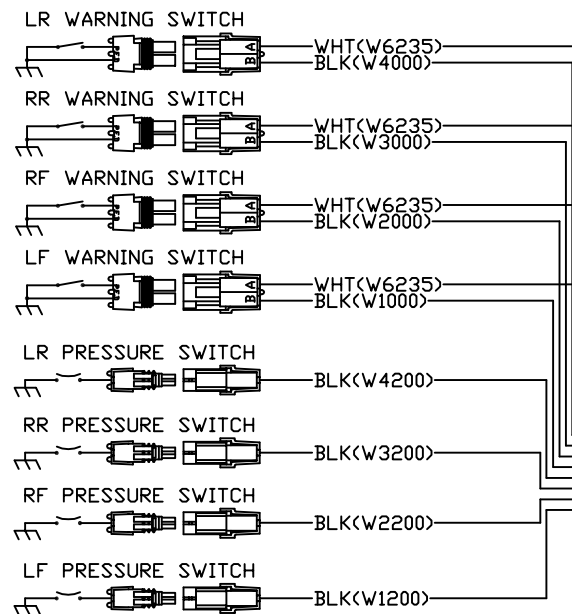
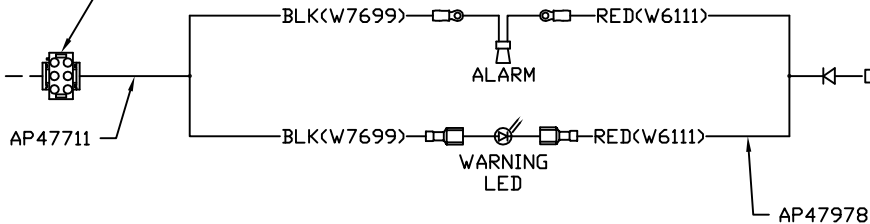

NOTE: INSTALLATION MUST CONFORM TO GOOD SHOP PRACTICES, SAE STANDARDS, RVIA STANDARDS, AND OTHER APPLICABLE STANDARDS.

MP91456 D
02MAY19

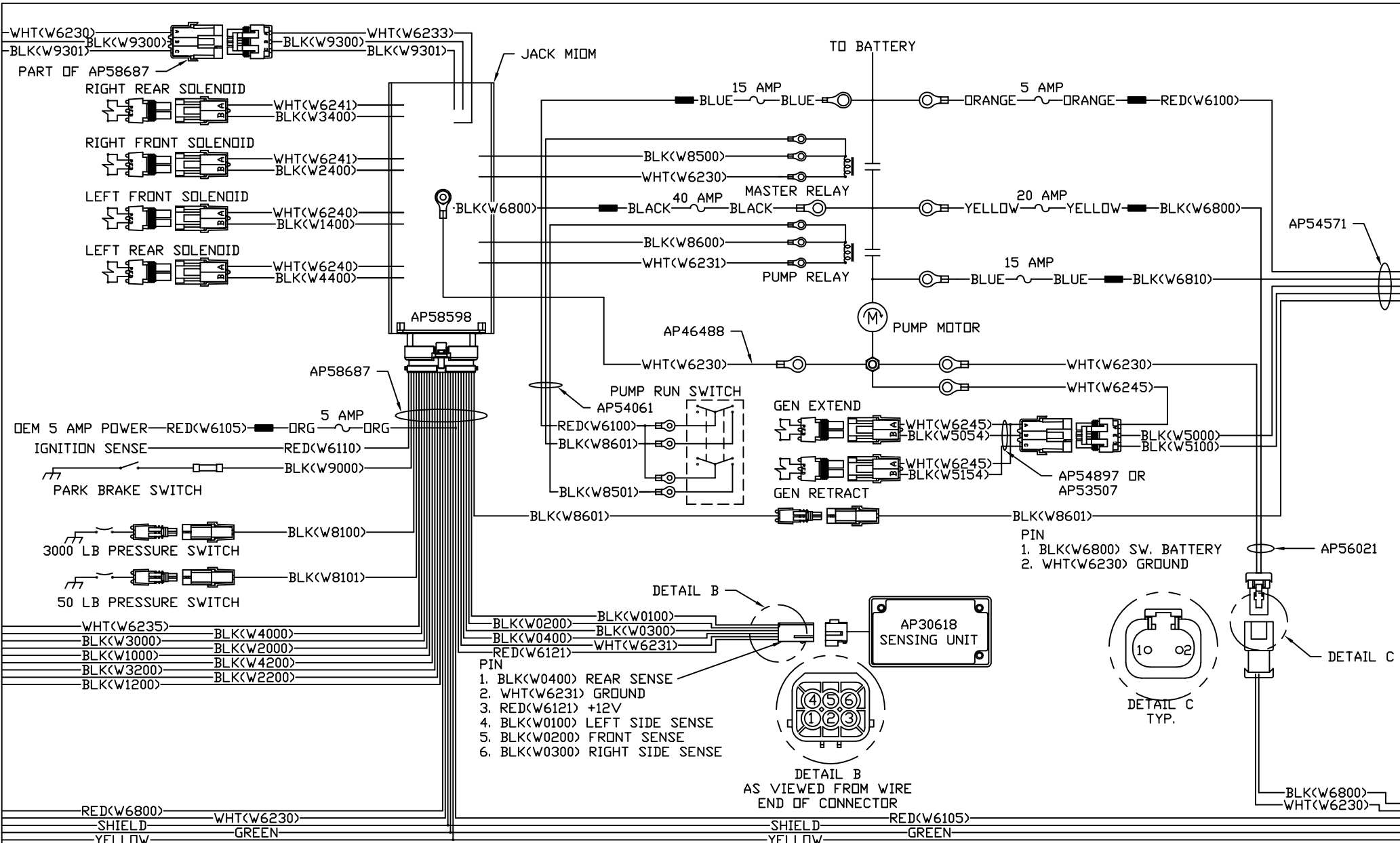

NOTE: INSTALLATION MUST CONFORM TO GOOD SHOP PRACTICES, SAE STANDARDS, RVIA STANDARDS, AND OTHER APPLICABLE STANDARDS.

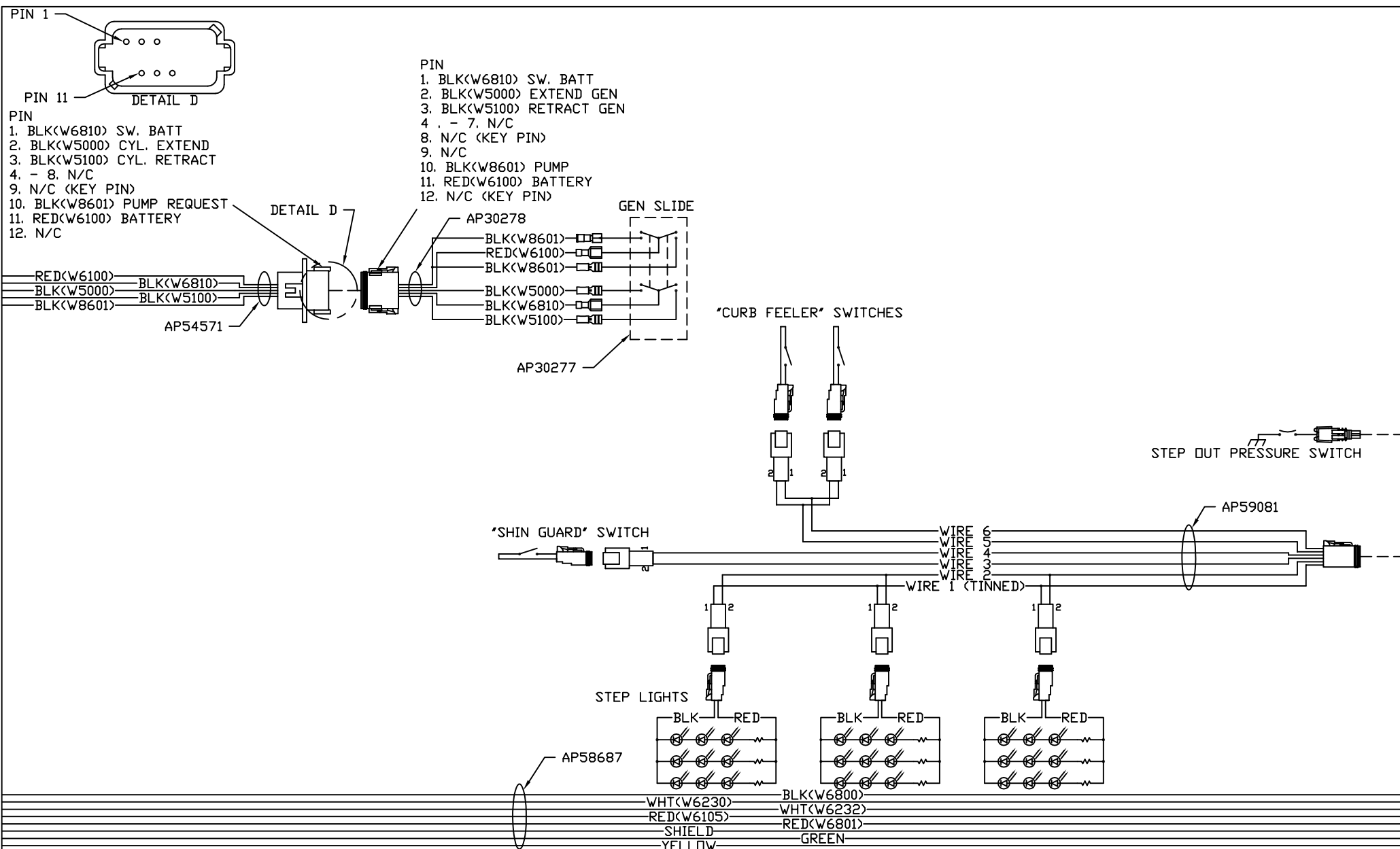

NOTE: INSTALLATION MUST CONFORM TO GOOD SHOP PRACTICES, SAE STANDARDS, RVIA STANDARDS, AND OTHER APPLICABLE STANDARDS.

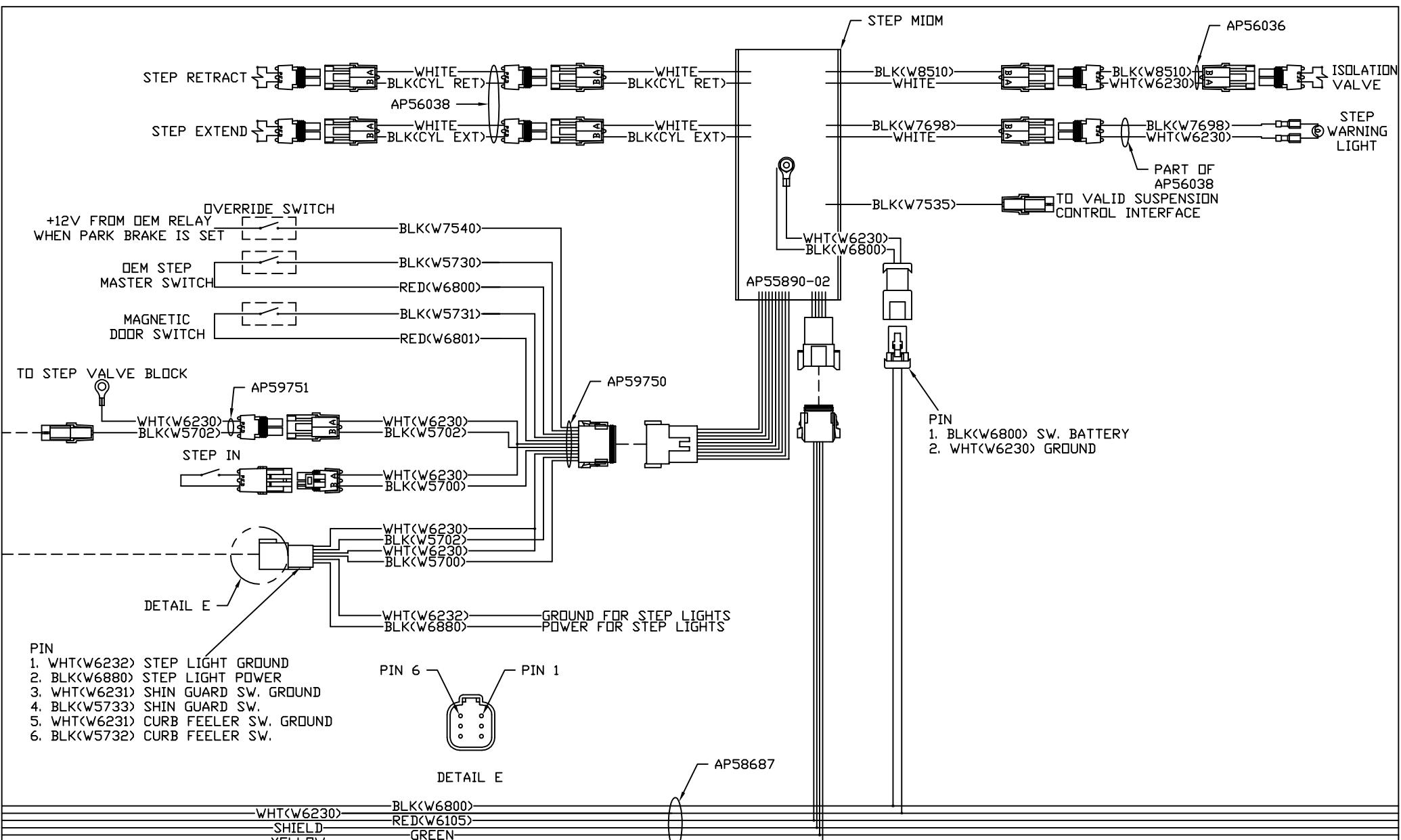

NOTE: INSTALLATION MUST CONFORM TO GOOD SHOP PRACTICES, SAE STANDARDS, RVIA STANDARDS, AND OTHER APPLICABLE STANDARDS.

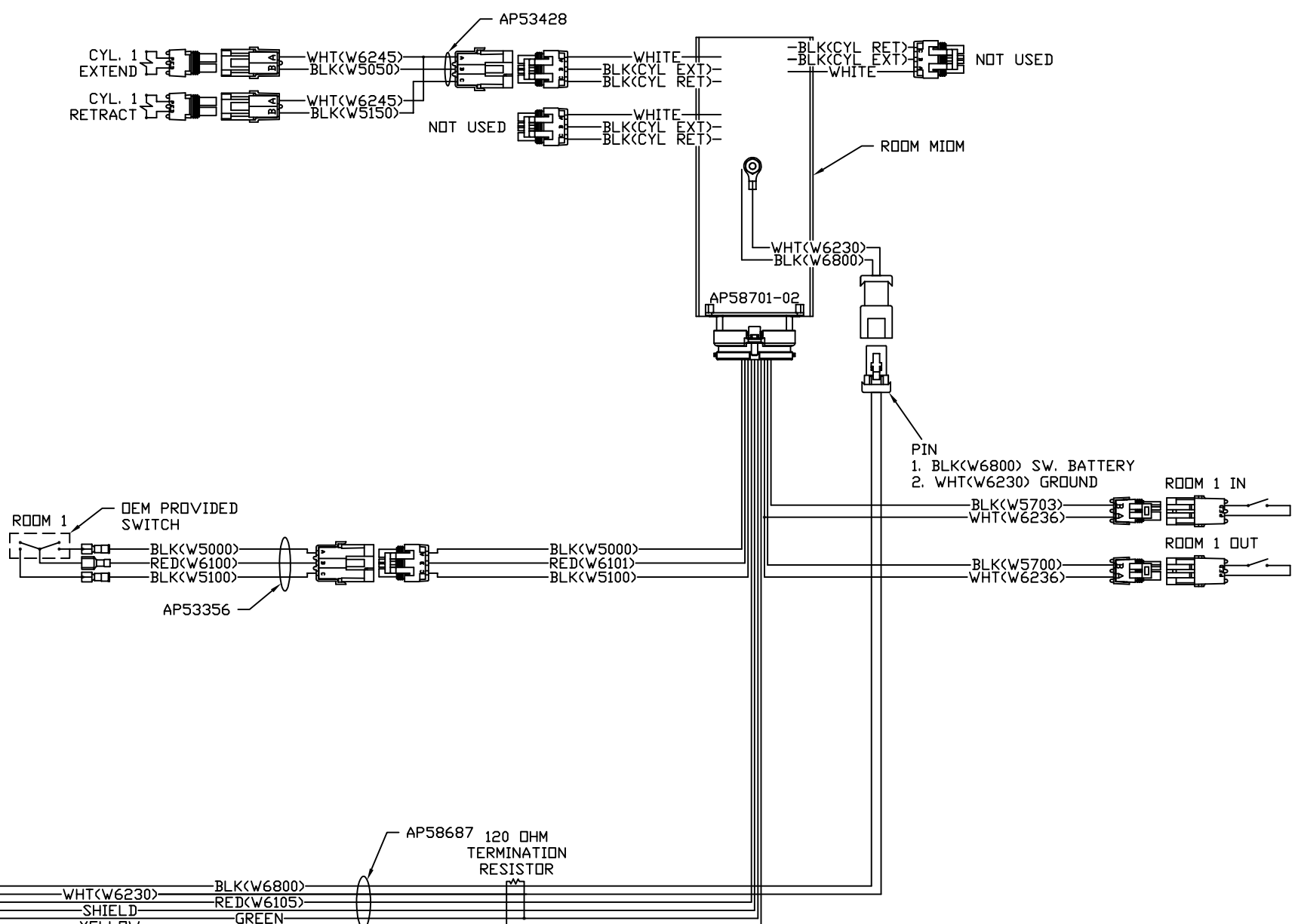

NOTE: INSTALLATION MUST CONFORM TO GOOD SHOP PRACTICES, SAE STANDARDS, RVIA STANDARDS, AND OTHER APPLICABLE STANDARDS.